

- Parts list -

Vehicle	WDDHF8HB9BA309250 (D02)	E 350 4MATIC Sedan	
Color	650 - undefined	Equipment	101 -
FIN: WDD2120871A309250		Assortment class	PC
Group	20 ENGINE COOLING	Sub-group	045 BELT TENSIONER

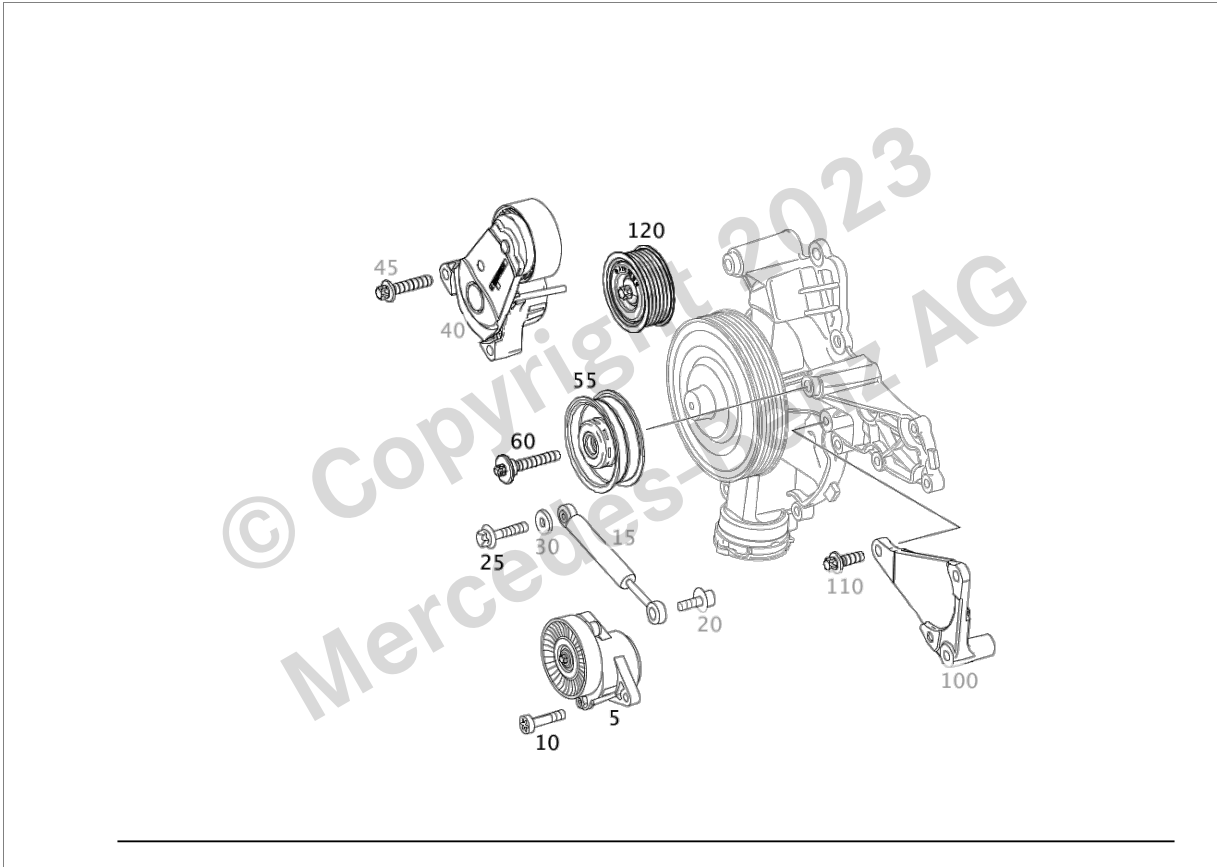









Image ID: drawing_B20045000135

Item	Part number	Designation/additional information	Qty
5	A 272 200 02 70	BELT TENSIONER Code: -(ME04);	1
10	N 000000 001536	HEXALOBULAR BOLT Belt tensioner to timing case cover Code: -(ME04);	2
25	N 000000 001141	HEXALOBULAR BOLT Shock absorber to water pump; M8X34	1
55	A 272 202 04 19 	GUIDE PULLEY Between belt tensioner and water pump Code: -(ME03/ME04); Replaced by: A 272 202 07 19 Replaced by: A 272 202 14 19	1
55	A 272 202 07 19 	GUIDE PULLEY Between belt tensioner and water pump Code: -(ME03/ME04); Replaced by: A 272 202 14 19 Replaces: A 272 202 04 19	1

Parts Information

Item	Part number	Designation/additional information	Qty
55	A 272 202 14 19 	GUIDE PULLEY Between belt tensioner and water pump  Code: -(ME03/ME04); Replaces: A 272 202 07 19 Replaces: A 272 202 04 19	1
60	A 001 990 48 03	SCREW, ROUND HEXAL. HEAD Guide pulley to water pump; M8X45  Code: -(ME03/ME04);	1
120	A 272 202 10 19 	GUIDE PULLEY To water pump 69 MM X 26.4 MM  Code: -ME03; Replaced by: A 272 202 00 00	1
120	A 272 202 00 00	GUIDE PULLEY To water pump 69 MM X 26.4 MM  Code: -ME03; Replaces: A 272 202 10 19	1