

- Parts list -

Vehicle	WDDHF5FB3EB057429 (D04)	E 300 Sedan	
Color	890 - undefined	Equipment	215 -
FIN: WDD2120551B057429		Assortment class	PC
Group	24 Engine suspension	Sub-group	015 Engine suspension

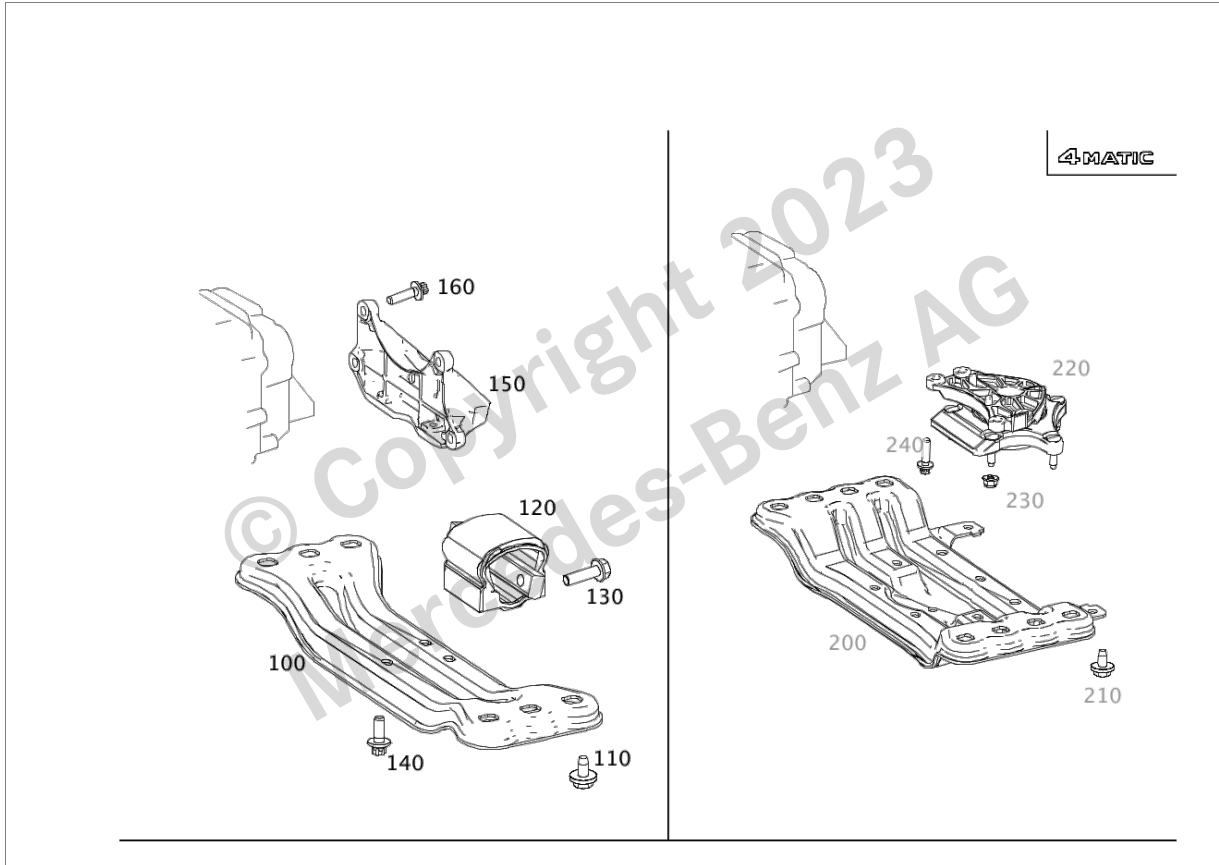















Image ID: drawing_B24015000256

Item	Part number	Designation/additional information	Qty
10	A 204 240 09 17	ENGINE MOUNT FRONT LEFT Code: (M272/M276)+-M005; Replaced by: A 204 240 43 17	1
10	A 204 240 43 17	ENGINE MOUNT FRONT LEFT Code: (M272/M276)+-(M005/ME04); Replaces: A 204 240 09 17	1
10	A 204 240 09 17	ENGINE MOUNT FRONT RIGHT Code: (M272/M276+-M002)+-M005; Replaced by: A 204 240 43 17	1
10	A 204 240 43 17	ENGINE MOUNT FRONT RIGHT Code: (M272/M276+-M002)+-(M005/ME04); Replaces: A 204 240 09 17	1

Parts Information

Item	Part number	Designation/additional information	Qty
20	A 212 241 07 34	SCREENING PLATE LEFT  Code: M276+-(M005/M002);	1
20	A 212 241 08 34	SCREENING PLATE RIGHT  Code: M276+-(M005/ME04);	1
30	N 910105 010003	HEXAGON HEAD BOLT ENGINE MOUNTING TO ENGINE SUPPORT; M10X60  Code: -(((M272/M273/M274)+M005)/(M278/M157));	2
40	N 000000 001114	HEXALOBULAR BOLT SHIELD TO ENGINE SUPPORT; M6X15  Code: M276/M278+-M005/M157;	4
50	N 910105 008014	HEXAGON HEAD BOLT FRONT ENGINE MOUNT ON FRAME-TYPE INTEGRAL SUPPORT; M8X35  Code: -M005;	4
100	A 212 242 14 01	ENGINE CARRIER REAR  Code: (M272/M276)+-(M005/M002/ME04);	1
110	A 003 990 08 03 	COMBI-SCREW ENGINE REAR SUPPORT TO FRAME; M10X20  Code: -M005;	6
120	A 212 240 04 18	ENGINE MOUNT REAR  Code: -(M005/M156+M63/M157+M55/M651/M002/M274/ME04);	1
130	N 000000 000428	HEXAGON HEAD BOLT BRACKET TO TRANSMISSION MOUNTING; M10X35  Code: -M005;	2
140	N 000000 000276	HEXALOBULAR BOLT ENGINE MOUNT REAR TO TRANSM. CARRIER; M8X20  Code: -M005;	3
150	A 211 242 03 40	BRACKET AT TRANSMISSION  Code: 427+-(M005/M156+M63);	1
160	A 004 990 34 12	SCREW BRACKET TO TRANSMISSION; M8X30  Code: (427/421)+-M005;	4