

## 7G-TRONIC (722.9) in the Workshop Tips and Tricks

Service Information Brochure



# 7G-TRONIC (722.9) in the Workshop Tips and Tricks

Service information brochure

## Ordering Workshop Information

All printed workshop information from GSP/TI, such as Introduction into Service Manuals, System Descriptions, Function Descriptions, Technology Guides, Technical Data Manuals and adhesive labels, can be ordered as follows:

### In Germany

Through our GSP/TI Shop on the Internet

Link: <http://gsp-ti-shop.daimlerchrysler.com>

or alternatively

Email: [customer.support@daimlerchrysler.com](mailto:customer.support@daimlerchrysler.com)

Phone: +49-(0)18 05/0 10-79 79

Fax: +49-(0)18 05/0 10-79 78

### Outside Germany

Please get in touch with the contact person responsible for your market.

## Product Portfolio

Comprehensive information about our full Product Portfolio can also be found at our Internet Portal.

Link: <http://open-after-sales.daimlerchrysler.com>

## Questions and Suggestions

If you have any questions or suggestions concerning this product, please write to us.

Email: [customer.support@daimlerchrysler.com](mailto:customer.support@daimlerchrysler.com)

Fax: +49-(0)18 05/0 10-79 78

or alternatively

Address: DaimlerChrysler AG

GSP/TIS

HPC R822, W002

D-70546 Stuttgart

© 2007 by DaimlerChrysler AG

This document, including all its parts, is protected by copyright.

Any further processing or use requires the previous written consent of DaimlerChrysler AG, Department GSP/TIS, HPC R822, W002, D-70546 Stuttgart. This applies in particular to reproduction, distribution, alteration, translation, microfilming and storage and/or processing in electronic systems, including databases and online services.

Image no. of title image: P00.01-3517-00

Order no. of this publication: 6516 1356 02

09/07

<b>Preface</b>	5
----------------	---

## **Introduction**

<b>Function and design</b>	6
<b>Functions from customer perspective</b>	8
<b>Design of transmission</b>	10

## **Useful information**

<b>Complaints</b>	14
-------------------	----

## **Work tips**

<b>Transmission number</b>	24
<b>Adaptation types</b>	25
<b>Shift adaptation</b>	26
<b>Adaptation data changes</b>	30
<b>Torque converter lockup clutch (KÜB)</b>	31
<b>Wear debris patterns</b>	32
<b>Oil level</b>	34

## Questions and answers

<b>Transmission 722.9</b>	36
<b>Oil pan, oil filter and magnets</b>	36
<b>Electrohydraulic controller unit</b>	36
<b>Converter object number</b>	37
<b>Torque converter lockup clutch shutoff</b>	37
<b>Shift adaptation</b>	37
<b>List of abbreviations</b>	38
<b>Index</b>	39



Dear reader,

This brochure is intended as a tool to answer any questions you may have and to help you in your day-to-day work on transmission 722.9 in the passenger car model series.

The function descriptions are structured in a familiar way but also contain explanations of customer experiences which will help you to explain the background to the functions to the customer.

This brochure is also intended to help you diagnose and repair technical problems and to explain the inter-relationships between problems and remedies.

All the technical data and remedies listed in this brochure are valid as of the copy deadline in July 2007.

Before performing a repair, confirm and, if necessary, modify the procedure described in this document by comparing it to the currently valid documents in WIS for your market.

DaimlerChrysler AG

Technical Information and Workshop Equipment  
(GSP/TI)

## Function and design

### Transmission 722.9

This section provides an explanation of the most important functions of transmission 722.9 and its interrelationships with other components to allow you to better understand the functions in the transmission or intelligent servo module (ISM).

An understanding of the function and technology of the transmission will allow you to explain customer experiences more easily. This will prevent the customer from having to wait while an enquiry is processed by the technical workshop support team.

#### **i** Note

A complete function description of transmission 722.9 and of the intelligent servo module can be found in WIS.

GF00.01-Z-9997AC

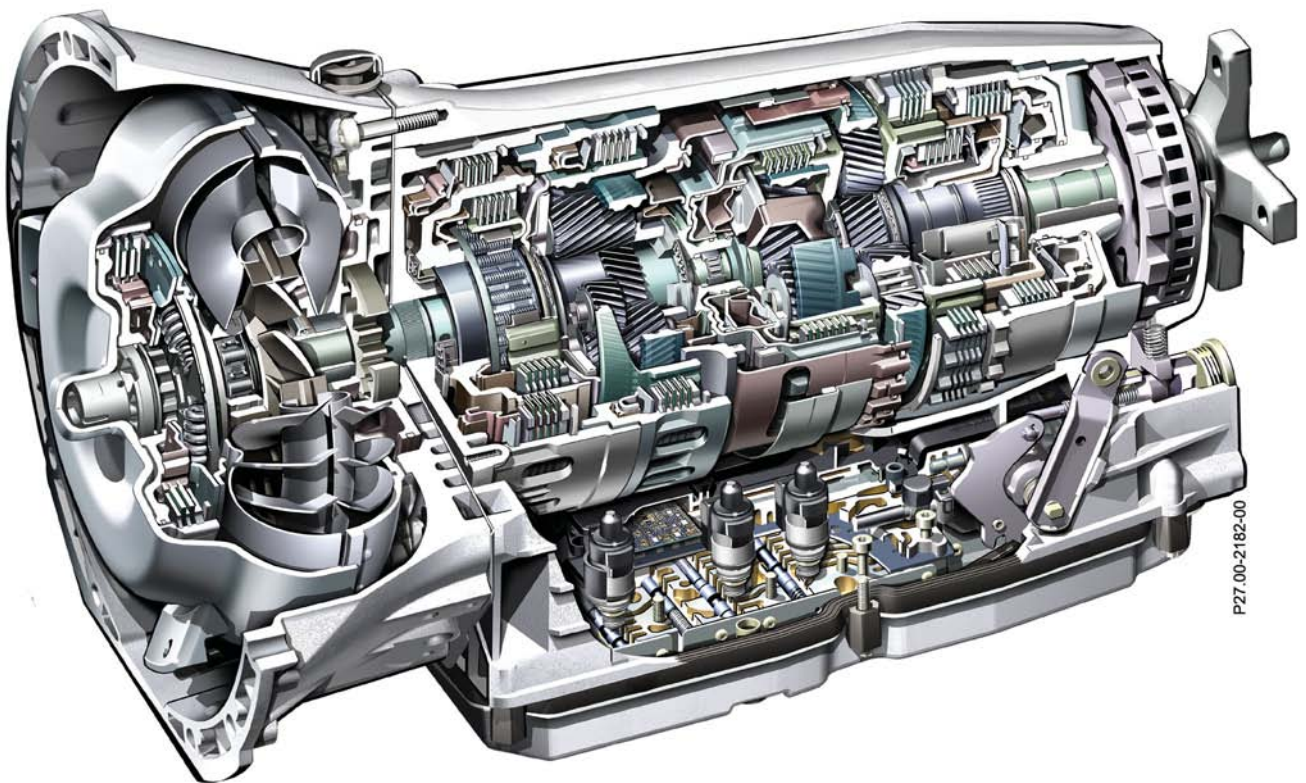

P27.00-2182-00

*Transmission 722.9*

### Automatic transmission and intelligent servo module

Shift line displacements:

A shift line displacement takes place when the control unit logic changes the shift points so that an upshift to the next gear up does not take place at the time expected by the customer but "later" i.e. at a higher engine speed.

A shift line displacement can be triggered by the following factors:

- Change in driving resistance (e.g. due to road surface incline)
- Increased aerodynamic drag (e.g. due to roof rack)
- Increased vehicle load (e.g. trailer)
- High transmission oil temperatures; in this case the shift is delayed to reduce heat development in the transmission.
- Detection of sporty driving style based on high cornering speeds and/or rapid accelerator pedal changes. This function is only active in S-mode.
- Requests from other control units (e.g. for temporary rpm increase to ensure proper operation of emission control system)

These factors can also cause the transmission to downshift "earlier" to the next gear down during deceleration i.e. the transmission also shifts down at higher engine speeds than expected.

### Start-off gear

Transmission 722.9 engages the start-off gear depending on the transmission mode and vehicle model. The following start-off gear strategy currently applies for MB passenger cars (does not apply to AMG):

- S-mode, vehicle always starts off in 1st gear
- C-mode diesel engine, 1st gear
- C-mode gasoline engine, 2nd gear
- Offroad vehicles in high-range, 1st gear
- Offroad vehicles in low-range, 2nd gear



## Functions from customer perspective

### Customer statement "Transmission stopped shifting"

Customer statements of this type can have various causes.

- **There is a malfunction in the transmission.** In this case, event codes and/or fault codes will be stored in the transmission control unit. This does not necessarily mean that the transmission is defective. The malfunction may also have been caused by missing CAN signals. The transmission fault codes as well as the engine and ESP fault codes must always be processed in this case.
- **Shift line displacement has taken place.** The customer may perceive a shift line displacement as a failure to shift if, for example, the shift line has been displaced significantly and the customer is reluctant to accelerate any further.
- **The vehicle does not switch to 7th gear under full load because the "6-7 full load" shift point cannot be reached.**

This predominantly occurs on vehicles with less powerful engines. On road surfaces with a slight incline or on flat road surfaces, the maximum speed may be reached under full load in 6th gear before the shift rpm is reached. The transmission only shifts to 7th gear when the accelerator pedal is released or when the vehicle can accelerate further due to a reduction in driving resistance (downhill slope).

### Customer statement "I was no longer able to shift"

The intelligent servo module (ISM) and gearshift lever are part of a shift-by-wire system. The shift pulses for changing the gear range (P, R, N, D) are transferred to the ISM as electrical signals where they are implemented after a plausibility check.

If a system fault occurs, the driver is notified of this by means of a display message. The driver should then drive to the next workshop without changing gear range, if possible. The next time the driver attempts to change gear range, it is possible that only "P" will be able to be engaged in the ISM by means of an emergency mechanism. It would then no longer be possible to continue driving the vehicle.

This does not necessarily mean that a component of the system is defective. The malfunction may also have been caused by a missing signal. It is therefore important to follow the respective test steps and pay attention to the fault codes of other control units when processing the stored fault codes.

Under the following conditions, the ISM automatically performs a gear change without storing a fault. These functions are system safety functions and not malfunctions:

- Ignition key is removed, "P" is engaged



## Functions from customer perspective

Prerequisite:

Driver did not previously shift to "N" himself/herself:

- Engine OFF and driver door is opened, "P" is engaged (KEYLESS-GO)
- Engine OFF and driver door is opened, "P" is engaged (as of SA code 808)

If the driver previously shifted to "N" himself/herself, "N" remains engaged after the driver door is opened (washing facility, towing).

- Engine OFF in gear range "D" or "R", "N" is engaged (as of SA code 808)

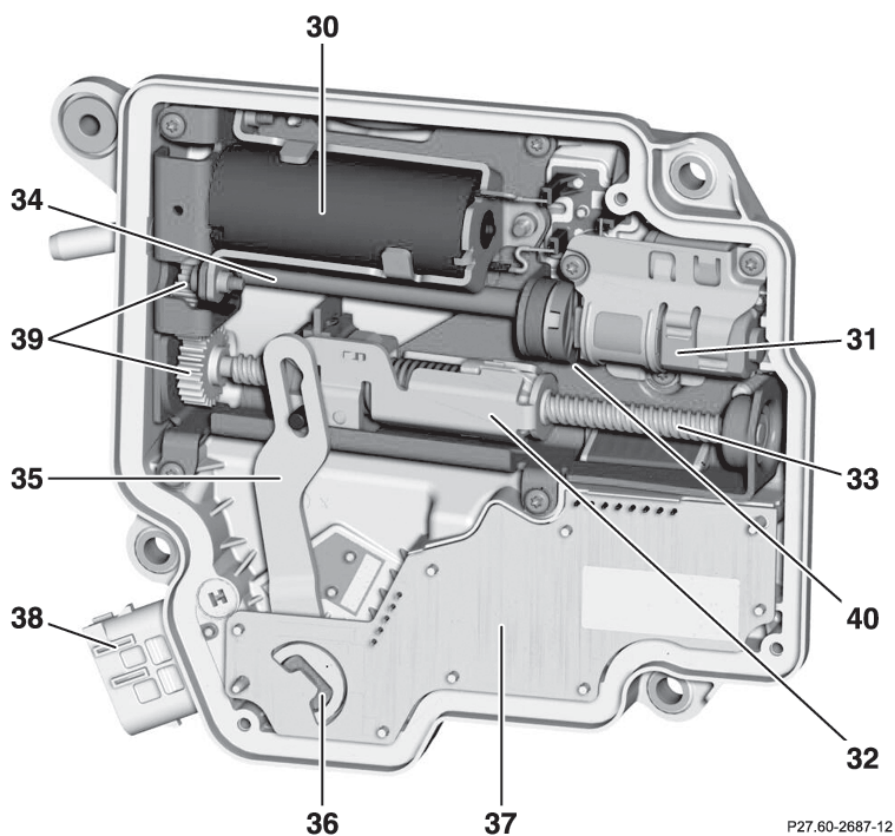

P27.60-2687-12

**Design, shown in range selector lever position "N"**

30	Main motor	36	Angle sensor
31	Emergency motor	37	Electronic systems
32	Slider	38	Connector plug
33	Threaded spindle	39	Drive gears
34	Eccentric shaft	40	Eccentric shaft position sensor
35	Range selector lever		

## Design of transmission

### Basic features

This section only describes important basic features of the transmission design to enable you to better understand the interrelationships between customer complaint, cause and remedy.

This table can also be used to derive interrelationships between components e.g. for adaptation or repair purposes.

### Actuators

Multidisk clutches (K1-K3) and multidisk brakes (B1-B3, BR):

To engage a gear in the transmission, 3 actuators must be actuated i.e. closed. The following table shows the actuators which must be closed to engage the respective gears. Refer to WIS for the associated power flow diagrams.

The 2nd reverse gear can only be engaged on vehicles which, according to the start-off gear strategy (see "Start-off gear" in the "Function and design" chapter), can also start off forwards in 2nd gear. This high-g geared reverse gear is however only engaged if "C"-mode was already active when gear range "R" was engaged or if the vehicle is in low-range mode. The gear ratio cannot be switched over once gear range "R" has been engaged.

Changing from one gear to the next gear up or down is only ever performed by changing one actuator i.e. one actuator is disengaged and another is engaged.

### Example:

The transmission only shifts as far as 2nd gear, 3rd gear cannot be engaged, the transmission switches to limp-home mode and a fault code is stored. If no remedy has been published for the symptom, the table can be used to determine that multidisk clutch K1 is the new actuator that is engaged for 3rd gear. The initial diagnosis would therefore be that multidisk clutch K1 is defective.



Actuated actuators

	K1	B1	B3	K3	K2	B2	BR
1st gear			●	●		●	
2nd gear		●		●		●	
3rd gear	●			●		●	
4th gear	●				●	●	
5th gear	●			●	●		
6th gear		●		●	●		
7th gear			●	●	●		
Neutral			●	●			
1st reverse gear			●	●			●
2nd reverse gear		●		●			●

## Design of transmission

### Torque converter lockup clutch (KÜB)

In addition to the actuators for performing gear changes, there is also a multidisk clutch for reducing converter slip inside the torque converter.

The multidisk clutch is fitted with 2 or 3 coated disks depending on the engine in the vehicle and the production date.

- M113 2 coated disks
- M156 3 coated disks
- M272 2 coated disks
- M273 initially 2 coated disks, switchover to 3 coated disks in 02/2007-06/2007 together with introduction of additional transmission cooler
- OM629 3 coated disks
- OM642 initially 2 coated disks, switchover to 3 coated disks in 02/2007-06/2007 together with introduction of additional transmission cooler

The torque converter lockup clutch is controlled based on many input factors that cannot be checked in the workshop. This document therefore does not include a description of the exact times and conditions under which the lockup clutch is engaged. Generally, the torque converter lockup clutch is engaged to optimize fuel consumption as of the 1st gear. However, its engagement is also dependent on transmission oil temperature, rpm, engine torque, operating environment (altitude) etc. Generally, the torque converter lockup clutch is only engaged if this allows energy consumption in the converter to be avoided. If the transmission oil temperature becomes so high that no more heat should be absorbed by the oil, the lockup clutch switches to minimum slip mode.



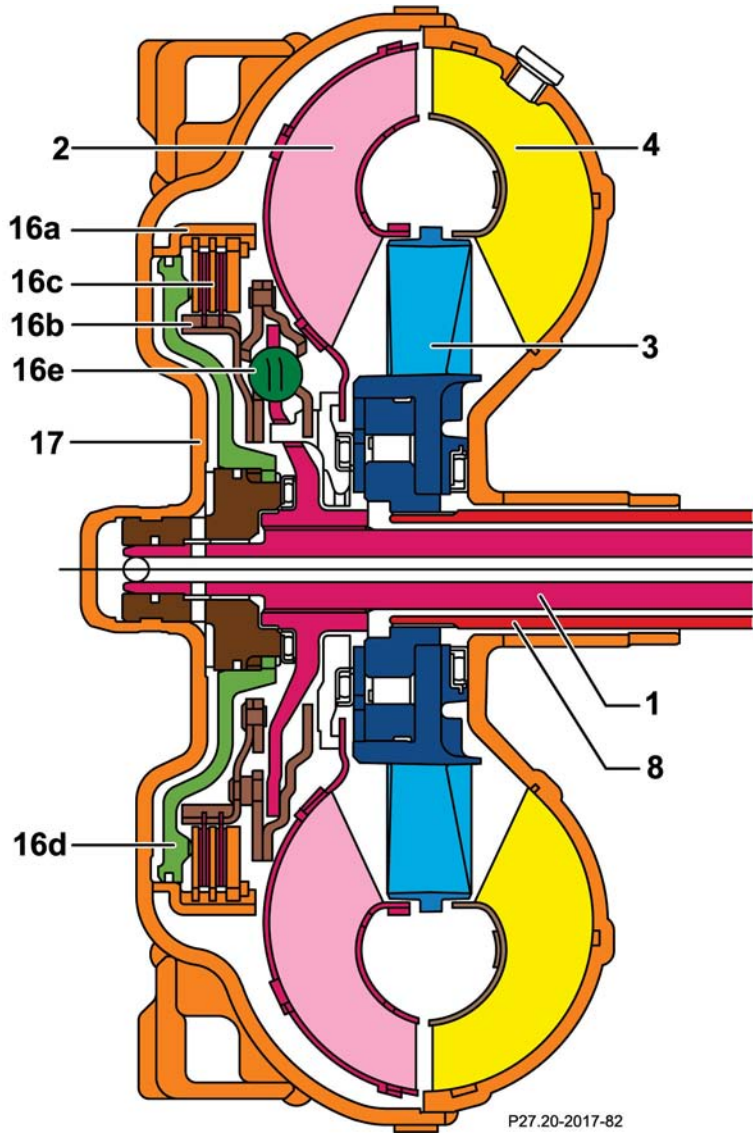

**Torque converter lockup clutch (KÜB)**

- 1 Drive shaft
- 2 Turbine wheel
- 3 Stator
- 4 Impeller
- 8 Stator shaft
- 16a External disk carrier
- 16b Internal disk carrier
- 16c Disk pack
- 16d Piston
- 16e Torsional damper
- 17 Torque converter housing

## Complaints

### Dealing with transmission 722.9 in the workshop

To allow you to deal with transmission 722.9 more reliably in the workshop, this chapter provides you with useful information about handling customer complaints, defects and remedies.

#### What is the problem ("Vehicle jolted while driving...")?

You must obtain a precise description of the problem from the customer in order to be able to rectify the customer complaint in the workshop. For complaints that only occur in certain situations, it is often beneficial to have the customer demonstrate the problem to you during a test drive.

This will allow you to identify which shift operations are affected and record the boundary conditions.

These data will help you to find a remedy and also to check whether the work that has been performed has actually eliminated the customer's problem.

This makes a significant contribution to customer satisfaction because it avoids repeat workshop visits.

#### Is there an actual malfunction or just a lack of understanding ("Vehicle starts off in 1st gear even in C, something is wrong")?

You must first understand the customer complaint before you can decide whether there is an actual malfunction or whether the customer is simply not aware of a particular function. The "Function and design" chapter specifies a number of functions which may be perceived as malfunctions by the customer.

If it is not possible to clarify in the workshop whether the issue at hand is a malfunction or an intended function, consult with the technical workshop support team before attempting any repairs.

## Eliminating complaints

If it is determined that the complaint is caused by a malfunction, continue with diagnosing and repairing the problem. Always consult the current documents (TIPS, WIS, test steps in Star Diagnosis) and process the instructions they contain where necessary. The following descriptions differentiate between 2 types of complaints:

- With fault codes
- Without fault codes

## Complaints with fault codes/event codes

Fault codes and/or event codes are stored in the transmission control unit either if there is a malfunction in the actual system (transmission) or if the system cannot react as normal e.g. due to missing data from other systems.

### Example 1:

An rpm sensor inside the transmission stops transmitting data to the control unit. The control unit software can therefore no longer monitor the transmission for proper operation and switches to limp-home mode. Since the rpm sensor fault is an internal system fault, a **fault code** is stored.

### Example 2:

The engine control unit does not transmit all required data to the transmission control unit. The transmission can continue to operate but, for example, the shift quality may suffer due to the missing data. In this case, an **event code** indicating which data is missing (CAN) is stored. There is initially no need to perform any action on the transmission. Event codes are also stored if the control unit is not operational due to a missing coding. In this case, no parts must be replaced but the control unit itself must be coded.

#### Note

The general rule to follow is that fault codes should be processed first (e.g. shift complaints may be caused by fault codes).

#### Note

The following section specifies certain fault codes and their remedies. Please note that the list is not complete and is not updated. Please refer to the information media TIPS, WIS and Star Diagnosis for the full, up-to-date documentation.



## Complaints

### Rpm sensor faults

Fault codes: 0717, 0718, 0722, 0723, 2200, 2201, 2204, 2205, 2206, 2207, 2767, 2768; transmission in limp-home mode (occasionally)

There are two possible types of rpm sensor fault:

- If the sensor itself is defective, the entire electrohydraulic controller unit must be replaced because neither the sensors nor the control unit with sensors can be replaced individually.
- The rpm sensor (magnetic ring or pulse ring) is defective or is not in the specified position. Since it is rarely possible to find an incorrectly positioned sensor ring, the first step to take for this fault profile is to replace the electrohydraulic controller unit.

### Faults in torque converter lockup clutch (KÜB)

Fault codes: 2511 or 2783

With this fault code, the controller cannot adjust the lockup clutch to the specified slip that has been calculated.

The cause of this may be:

- The disks of the lockup clutch are worn.
- The friction value of the disks has changed.
- Hydraulic actuation is not possible.

If there is a significant amount of wear debris in the transmission oil pan (see picture), it must be assumed that the torque converter lockup clutch is already seriously damaged.

In this case, it is recommended that the entire transmission including torque converter be replaced because the shavings will have spread out within the transmission. In addition, the oil cooler must be flushed. If an additional oil cooler with thermostat is installed, this must also be replaced because it cannot be flushed (thermostat does not open until temperature of approx. 85 °C is reached).

#### **i** Note

The control unit with sensors cannot be replaced individually because the characteristics of all valves are determined and stored in it during production. This is also the reason why individual valves cannot be replaced.



*Oil pan with significant wear debris*

If the wear debris pattern in the oil pan is not unusual:

- 1 Remove the converter return flow strainer (installed on transmissions up to sequence number 467 000)
- 2 Clean the fine-mesh filter of the torque converter lockup valve (electrohydraulic controller unit removed, remove torque converter lockup valve, carefully clean fine-mesh filter with lint-free cloth)
- 3 Perform an oil change
- 4 Erase all adaptation data in the transmission control unit (in future it will be possible to erase the torque converter lockup clutch adaptation data separately)

Clean valves:

- 1 Unscrew bolt
- 2 Remove tension spring
- 3 Remove both valves (torque converter lockup clutch valve and working pressure control valve)
- 4 Carefully remove particles from fine-mesh filter using a cloth
- 5 Insert valves
- 6 Insert tension spring
- 7 Tighten bolt to 9 Nm

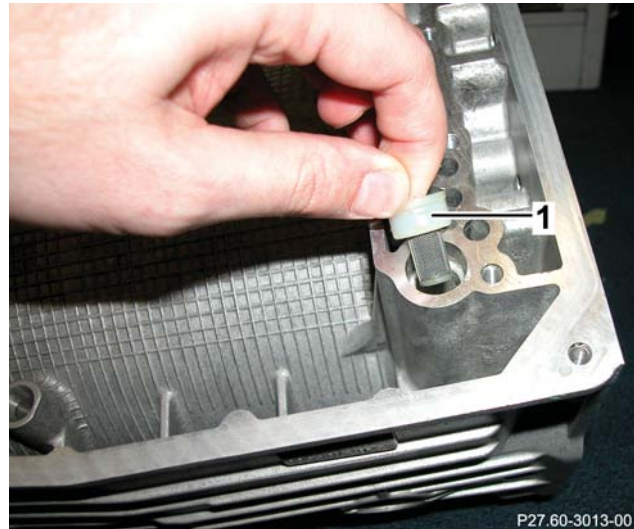

1 Converter return flow strainer  
**Electrohydraulic controller unit removed, front of transmission housing, on left in direction of travel**

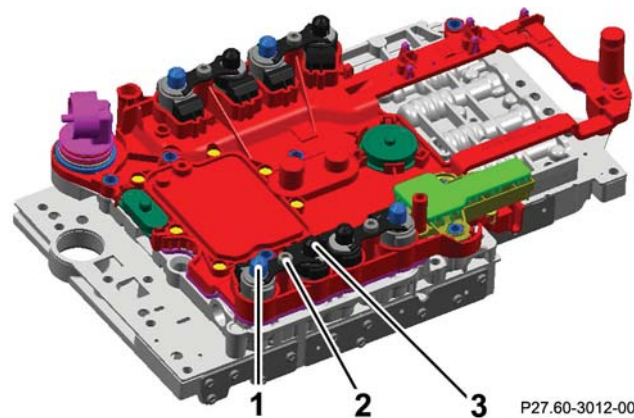

1 Torque converter lockup clutch valve  
2 Bolt  
3 Working pressure control valve  
**Clean torque converter lockup clutch valve and working pressure control valve**

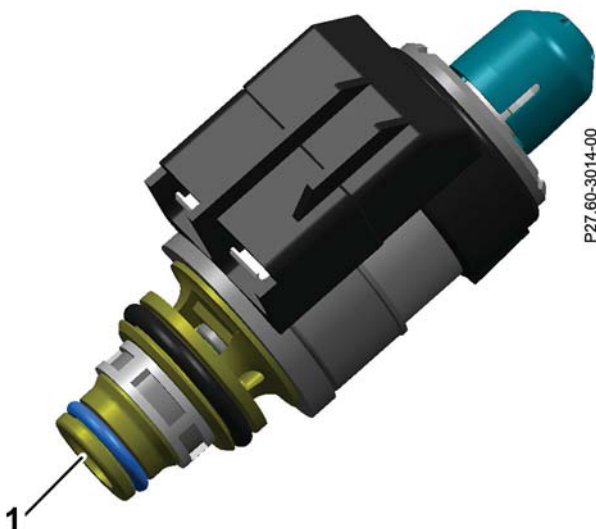

#### Valve

- 1 Fine-mesh filter

## Complaints

### Faults in control solenoid valve

Fault codes: 2110, 2111, 2112, 2113, 2114, 2115, 2116, 2117, 0748, 0778, 0798, 2716, 2725, 2734, 2759, 2810; individual gears not available, transmission in limp-home mode (occasionally)

It is not possible to check the control solenoid valves for proper operation via the control unit or software. Only the electrical resistance of the valves is checked by means of a voltage and current strength monitoring function.

If there are any deviations from the specified values, there is a short circuit or open circuit and the electrohydraulic controller unit must be replaced.

### Faults in actuators

Fault codes: 0894, 2502, 2505, 2711; and transmission in limp-home mode (occasionally) or no power transmission

These fault codes are always generated when the software detects a malfunction via the rpm sensor signal monitoring function. The cause of the malfunction can sometimes be determined based on the symptom.

If one or more of these fault codes are stored but there is or has been no complaint of this type then no action is required.

#### Note

The valves cannot be replaced individually because the characteristics of all valves are determined and stored in the control unit during production.

#### Note

Only fault code entries combined with one of the symptoms "Transmission in limp-home mode" (even occasionally) or "Occasionally no power transmission by transmission" are dealt with here.

**Example 1:**

If these fault codes occur when shifting from 2nd to 3rd gear (also see Actuators) or if 3rd gear is entered in the freeze frame data of the fault codes, multidisk clutch K1 is malfunctioning.

The cause may be located in the area from the valve to the hydraulic duct including seals through to the piston. As a result, the probable faults that have been found to be associated with this type of symptom are specified as causes in the current documents with corresponding remedies.

In this case, replacement of the entire multidisk clutch K1 would be specified as the remedy.

**Example 2:**

If the above-specified fault codes occur in combination with significant wear debris, there is mechanical damage inside the transmission or torque converter. In this case, the transmission and torque converter must be replaced and the oil cooler must be flushed as per the current documentation. If an additional oil cooler with thermostat is installed, this must also be replaced because it cannot be flushed (thermostat does not open until temperature of approx. 85 °C is reached).

A pattern of wear debris in the oil pan which corresponds to the picture "Oil pan with normal wear debris" does not justify replacement of the transmission because this is normal wear debris which collects in the oil pan during operation.

See the TIPS and Star Diagnosis documentation for further possible causes and remedies for this fault profile.

**i Note**

In this case, multidisk clutch K1 is replaced due to a probable leak at the piston. The piston itself is not available as a separate part because the sealing lips vulcanized on to it can be easily damaged during transport and handling.



*Oil pan with significant wear debris*

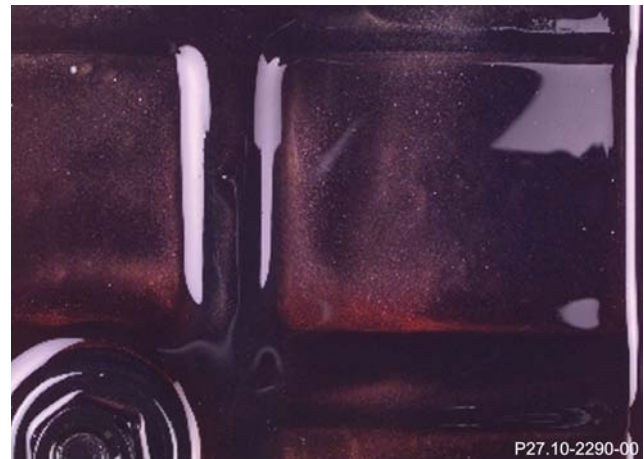

*Oil pan with normal wear debris*

## Complaints

### Faults in actuators

Fault codes: 0894, 2502, 2505, 2711; in combination with shift quality complaints.

If you find that one or more of these fault codes are stored when diagnosing shift quality complaints, these codes probably have no effect on the complaint.

You can therefore still process the diagnostic tree for shift quality complaints in this case.

### Complaints without fault codes/event codes

With comfort-related complaints, the functional processes in the transmission control unit are not interrupted and the controller cannot detect any malfunction. For this reason, no fault or event codes are stored for shift quality complaints as long as the target gear is engaged within the specified time.

The shift quality is nevertheless monitored by comparing the rpm patterns inside the transmission with ideal patterns during the shift operation. If the controller detects deviations from the specified shift operation patterns, parameters are changed to match the pattern to the ideal pattern. These changeable parameters are the adaptation data (see Adaptation types).

Complaints without fault codes can also include, for example, possible leaks or noise complaints that occur in certain driving conditions. In this case, it is essential that you know the conditions under which the fault occurs before processing the fault - either based on a detailed description or, ideally, by reproducing the complaint yourself. Otherwise, you will not be able to check whether your repairs have been successful.

## Shift quality complaints (gear change)

This type of complaint occurs when the change from one gear to another deviates so far from the ideal shift pattern that the vehicle jolts during driving operation. To eliminate the problem, process the currently valid diagnostic tree step-by-step until the complaint is remedied.

This document does not include a detailed illustration of the full diagnostic tree. See the respective information media (TIPS, Star Diagnosis) for the current diagnostic tree.

## Comfort-related complaints in torque converter lockup clutch (KÜB)

If the vehicle jolts during driving operation when the torque converter lockup clutch engages and not during gear changes, the fault must be processed differently.

If you have trouble determining whether the problem is caused by shift operations or by uncomfortable torque converter lockup clutch engagement, the example below may help you to make the decision.

### Example:

If the jolting generally occurs at the same time as the 1-2 shift operation, during the next attempt limit the shift range to the first gear using the selector lever or steering wheel gearshift buttons.

If the jolt is still noticeable just after starting off even though the transmission has not shifted up, the problem is highly likely to be related to torque converter lockup clutch engagement.

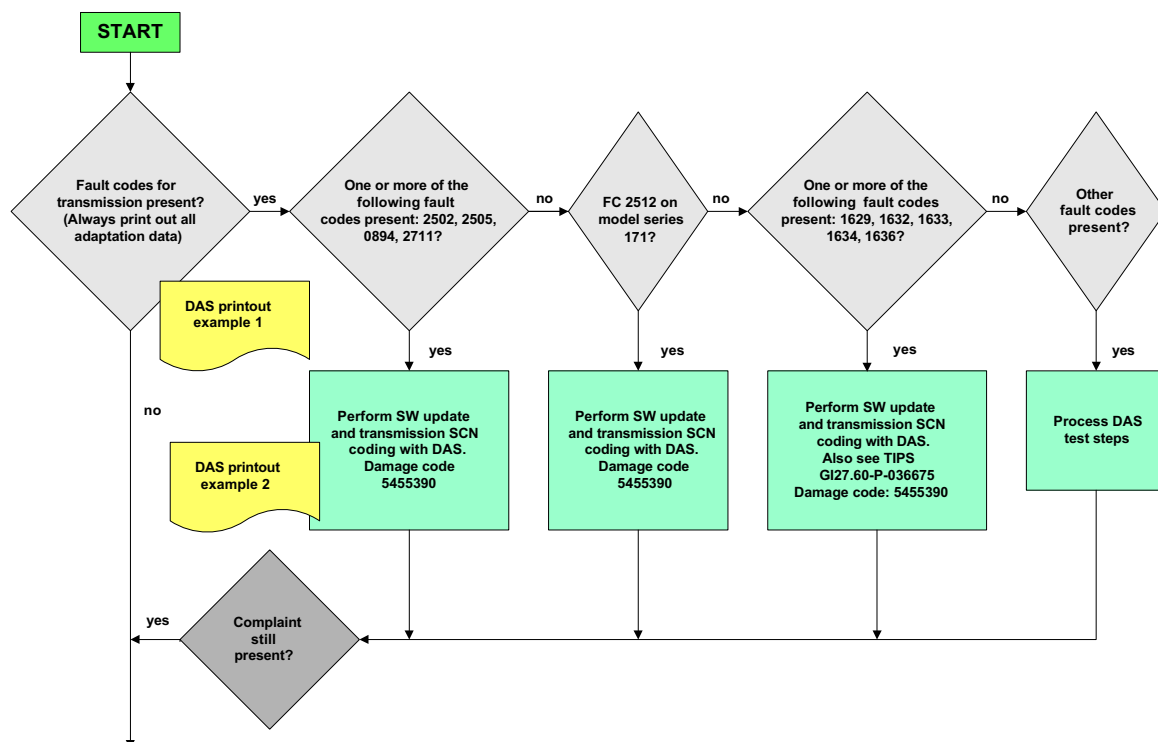

Example: Shift quality complaints on automatic transmission 722.9

## Complaints

### Noticeable engagement of torque converter lockup clutch (KÜB)

The first step is to perform full adaptation of the torque converter lockup clutch (see "Adaptation of torque converter lockup clutch"). Engagement and control of the torque converter lockup clutch can also be influenced by adaptation data to compensate for deviations in engine torque or changes in friction values.

If the problem cannot be eliminated by adapting the torque converter lockup clutch, the transmission oil pan must be checked for wear debris. If the wear debris pattern corresponds to the pattern in the picture but no fault codes are stored, the torque converter must be replaced and a transmission oil change must be performed.

If the wear debris pattern in the transmission oil pan is normal, the electrohydraulic controller unit must be replaced.

### Rubbing or humming/droning in torque converter lockup clutch (KÜB)

If engagement of the torque converter lockup clutch is not perceived as a jolt, but rather as a "rubbing noise", the cause of the problem is highly likely to be related to changes in the friction values of the disk linings in the torque converter.

If the complaint has occurred without any parts being replaced, adaptation is not necessary. However, changing the oil or flushing the transmission with transmission oil may eliminate the problem.

If the transmission oil change does not solve the problem, the torque converter must be replaced even if the typical pattern of wear debris in the transmission oil pan is not present.

Replacing the electrohydraulic controller unit when these symptoms are present will not solve the problem.

#### **i** Note

This step may also be necessary after the adaptation data are reset if, for example, the torque converter was replaced or the adaptation data were lost due to replacement of the electrohydraulic controller unit.



*Oil pan with significant wear debris*

## Transmission leaks

Theoretically, leaks can occur at all seals and sealing surfaces of the transmission. In this case, it is particularly important to localize the leak in order to be able to rectify the cause. It may be necessary to clean the area contaminated with oil and then spray the area with leak detector spray to narrow down the area of the leak during a test drive.

### Example:

The front area of the transmission is contaminated with oil. The oil might have escaped from the torque converter housing (leaky oil drain screw on torque converter, leaky radial shaft sealing ring on oil pump) or from the front edge of the oil pan gasket.

After cleaning and whitening the contaminated areas, you are able to determine that the oil pan gasket is leaky during a test drive.

The oil pan gasket is then replaced to remedy the problem. It is important to ensure that the seal is fitted to the oil pan in a "dry" state i.e. free of oil.

## Work tips

This chapter is intended as an information source and describes complicated procedures with background information.



## Transmission number

### The transmission number (not the MB object number)

The transmission number is a 14-digit number which indicates both the transmission variant and transmission sequence number.

It allows the engine and, if relevant, displacement variant which the transmission is intended for to be identified at a glance.

#### Example:

**722 9 04 01 114777**

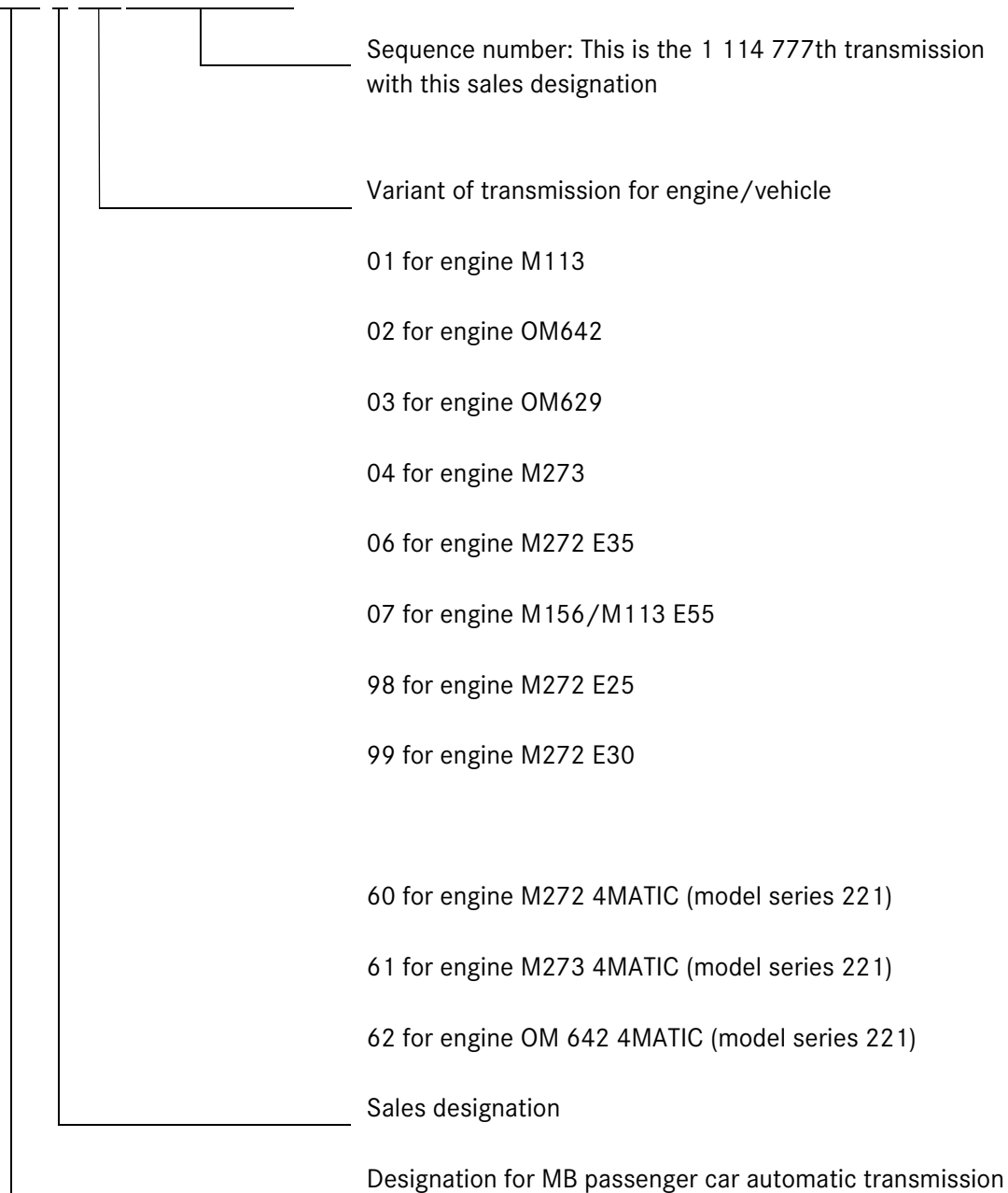

### The "3 types of adaptation"

Adaptation = Adjustment. But what are we adjusting the transmission to?

There are 3 different types of adaptation for the transmission control unit:

#### Control unit adaptation

Control unit adaptations (or settings/adjustments) are required to match the control unit to the respective vehicle. The "Control unit adaptations" menu in Star Diagnosis summarizes the various options e.g. teach-in to drive authorization system, variant codings or teach-in of selection range sensor. These adaptations are performed once and do not change automatically.

#### Shift line adaptation

During driving operation, the software monitors and controls adaptation of the shift program and thus of the shift line displacement. Displacements can be triggered by driving resistance and driving style etc. (see "Shift line displacements"). This process of adapting to the driving situation takes place continuously and the settings are erased when the ignition is switched off (or if "normal" driving conditions return first).

#### Shift adaptation

The process of shift adaptation for optimizing gear change operations also takes place continuously in the control unit. However, the shift operations must take place under certain conditions (engine rpm and load) in this case. This means that the driving style affects how often the transmission is adapted. As a result, this adaptation can be initiated by deliberately reproducing the relevant conditions while driving.

The procedure is described in the following chapter (shift adaptation).

## Shift adaptation

### Fundamentals of shift adaptation

The shift adaptation process, which runs during every shift operation that meets the conditions, determines correction values for the basic data set in the control unit with the intention of producing the ideal shift pattern.

Various types of adaptation data are obtained during the process, two of which are described here:

#### Fill time adaptation (FZA):

Correction of time value for filling the actuator being engaged (displayed in Star Diagnosis, values in cycles (= 10 ms))

#### Application pressure adaptation (ADA):

Correction of pressure value for applying the actuator being engaged (displayed in Star Diagnosis, values in mbar).

Each of these adaptation values is determined for 3 temperature ranges. If values for a temperature range are not yet available, the existing values for other temperature ranges are converted. Transfer of the correction values determined during adaptation to the read-only memory (E<sup>2</sup>PROM) takes place cyclically, every 10 min at the latest. As a result, the engine must be left running for 10 min before the ignition is switched off after an adaptation test drive for a faulty shift type or the adaptation process in Star Diagnosis must be properly terminated with the engine running (the results page for the adaptation test drive is displayed).

The following graphic provides a schematic illustration of the influence of the adaptations types on the pressure curve of an actuator being engaged (shift pattern of an acceleration upshift).

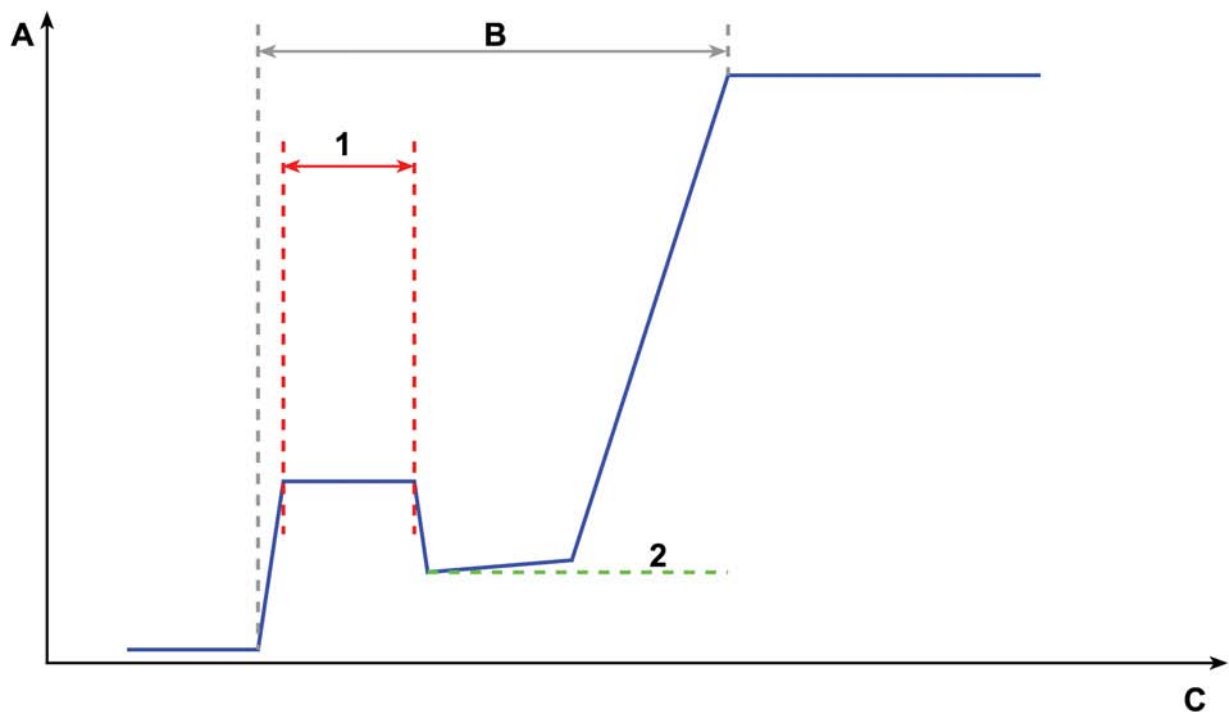

P27.60-3015-00

### Shift adaptation

A Pressure  
B Shift operation  
C Time

1 Fill time  
2 Application pressure

## Performance of shift adaptation

If a shift operation is subject to complaint and in need of adaptation, the adaptation must be selected in the transmission adaptation menu of Star Diagnosis.

After selecting transmission control, the shift type which is faulty and needs to be adapted must be selected.

Always pay attention to the safety information about performing adaptation in Star Diagnosis.

### Upshifts:

Shift operations to the next gear up can be adapted here.

### Downshifts:

Shift operations to the next gear down when the vehicle is decelerated with or without braking can be adapted here. The accelerator pedal is not actuated.

### Acceleration downshifts:

Shift operations to the next gear down when the vehicle is accelerated again or further by depressing the accelerator pedal can be adapted here. This type of adaptation must also be used for downshifts which are initiated by tapping the gearshift lever or steering wheel gearshift buttons. Direct adaptation is not possible for these acceleration downshifts/selector lever downshifts. As a result, the shift element being engaged must be adapted during an acceleration upshift. Star Diagnosis automatically switches to the adaptation menu for the 1-2 upshift if the 3-2 acceleration downshift is selected.

#### Note

It is only necessary to reset the adaptation data if mechanical repairs (adjustment operations or component replacement) were performed on the actuators. If only one adaptation needs to be performed, the data must not be erased first because this would mean that data collected over several thousand kilometers is lost.

#### Note

For the 3-2 acceleration downshift, multidisk brake B1 engages under load. This is also the case for the 1-2 upshift, which is why the same adaptation values apply.

## Shift adaptation

### Step-by-step performance of an upshift adaptation

- 1 Select the shift operation for adaptation in the menu.
- 2 The transmission oil temperature threshold of 60 °C must be exceeded.
- 3 Using the selector lever or steering wheel gearshift buttons, restrict the transmission to the start gear of the shift operation. For a 2-3 adaptation, restrict to "2".
- 4 Drive and bring both indicators (torque and rpm) into the green range.
- 5 Initiate the upshift using the selector lever or steering wheel gearshift buttons.
- 6 Pay attention to the acoustic and visual adaptation feedback; adaptation was only completed if feedback was given.
- 7 Repeat steps 3-7 a total of 5x, then evaluate the change.

The next Star Diagnosis screen shows the values from before and after the adaptation so that the changes are documented. When you switch to this screen, the adaptation values are permanently stored.

Shift quality after 5 adaptations:	Good	Better, but not yet good	No change or worse
Further measures:	Store data	Perform 5 more adaptation shift operations	Adaptation (ADA, FZA) is not cause of problem

#### Note

On vehicles with the "M" shift program, this program may **not** be used because the adaptation function is disabled in this case (sporty driving style).

## Step-by-step performance of a downshift adaptation

- 1 Select downshift menu
- 2 The transmission oil temperature threshold of 60 °C must be exceeded.
- 3 Adjust transmission to the upper gear of the shift operation subject to complaint and allow vehicle to roll unbraked until the problematic shift operation takes place.
- 4 Pay attention to the acoustic and visual adaptation feedback; adaptation was only completed if feedback was given.
- 5 Repeat steps 3-7 a total of 5x, then evaluate the change.

The next Star Diagnosis screen shows the values from before and after the adaptation of all downshifts so that the changes are documented. When you switch to this screen, the adaptation values are permanently stored.

Vehicles which only perform the 2-1 downshift at standstill will not reach 1st gear unbraked. In this case, the vehicle must be braked "normally" from 2nd gear to standstill, as described in Star Diagnosis.

Manually downshifting to first gear will not result in successful adaptation.

Example:

To adapt the 4-3 shift operation, accelerate the vehicle to 4th gear and then allow it to roll until 3rd gear is reached.

## Step-by-step performance of an acceleration downshift adaptation

This is performed in the same way as an upshift because Star Diagnosis switches to the corresponding screen for the respective upshift.

Shift quality after 5 adaptations:	Good	Better, but not yet good	No change or worse
Further measures:	Store data	Perform 5 more adaptation shift operations	Adaptation (ADA, FZA) is not cause of problem

### Note

On vehicles with the "M" shift program, this program may **not** be used because the adaptation function is disabled in this case. (sporty driving style)

## Adaptation data changes

### What if there is no "beep"?

If a shift operation is performed in the green range (or a downshift without braking) and there is no confirmation beep from Star Diagnosis, this can have various causes, both simple and complicated.

The list below is intended to explain the possible causes and demonstrate possible solutions.

#### No change in adaptation data

- 1 The adaptation data were not changed because the current adaptation data for the shift operation are ideal.

**Explanation:** Star Diagnosis cannot determine whether a computation cycle has taken place in the control unit, it can only detect whether there has been a change within the adaptation data range. This check monitors the entire data range meaning that, for example, an audible beep will still be output in the menu of the 2-3 shift operation if a downshift adaptation takes place. It is not possible to restrict monitoring to the selected shift operation.

#### Star Diagnosis speaker

- 2 The Star Diagnosis speaker is switched off or too quiet.

**Solution:** Activate speaker

#### Engine torque

- 3 The engine torque during the shift operation was too high or too low although the bar of the engine torque indicator was in the green area.

**Explanation:** Star Diagnosis can only display the engine torque on the screen but the control unit performs calculations based on the turbine torque which is usually similar but can be different.

**Solution:** Perform the shift operations in the red areas at the edge of the green area and not in the green area.

#### Deactivation of transmission control unit

- 4 Adaptation was deactivated in the transmission control unit.

**Explanation:** Transmission control deactivates the adaptation function on vehicles with diesel engine if, for example, diesel particulate filter purging is active because there can be signal deviations during this period.

**Solution:** Wait for purging cycle to end (purging is complete when the exhaust temperature upstream of the diesel particulate filter in the partial-load range is less than 250 °C). Adaptation can then be performed again.

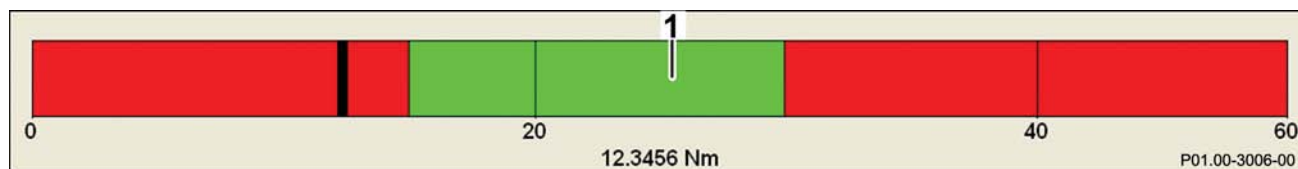

#### Engine torque indicator

- 1 Engine torque

#### **i** Note

A message is currently being added to Star Diagnosis to indicate if a purging cycle is active during adaptation.

## Torque converter lockup clutch (KÜB)

### Adaptation of torque converter lockup clutch (KÜB)

Just as shift operations can be adapted, the torque converter lockup clutch can also be adapted. This is necessary when there are comfort-related complaints when the torque converter lockup clutch engages because components such as the torque converter were replaced previously (also see the "Complaints without fault codes" section).

Always pay attention to the safety information about performing adaptation in Star Diagnosis.

There are 2 procedures for adapting the torque converter lockup clutch:

- Adaptation via coolant temperature
- Adaptation in 3 torque windows

### Adaptation via coolant temperature:

- 1 Perform cold start
- 2 Engage gear range "D"
- 3 Move steering wheel to straight-ahead position and brake vehicle for 30 s with service brake
- 4 Drive until the coolant temperature has risen by approx. 20 °C
- 5 Repeat steps 3 and 4 until the operating temperature of 80-90 °C is reached.

### Adaptation in 3 torque windows:

- 1 Transmission oil temperature must be over 60 °C
- 2 Gears 3 to 5 are best suited for the following steps (if necessary limit the transmission to these gears with the gearshift lever) as is driving on a level road surface at a speed between 40 and 80 km/h.
- 3 Drive within the torque range of 20-40 Nm (speed between 1,500 and 2,500 rpm) and maintain for at least 5 s (menu for 2-3 upshift suitable for display). If it was not possible to maintain the torque range for 5 s, repeat this step.
- 4 Drive within the torque range of 40-80 Nm (speed between 1,500 and 2,500 rpm) and maintain for at least 5 s (menu for 5-6 upshift suitable for display). If it was not possible to maintain the torque range for 5 s, repeat this step.
- 5 Drive within the torque range of 80-150 Nm (speed between 1,500 and 2,500 rpm) and maintain for at least 5 s (menu for 6-7 upshift suitable for display). If it was not possible to maintain the torque range for 5 s, repeat this step.

#### **i** Note

Menu-assisted adaptation of the torque converter lockup clutch (KÜB) is currently being added to Star Diagnosis. The manual procedure is described here nevertheless.



## Wear debris patterns

### Evaluation of wear debris patterns in oil pan

Wear debris in the form of metallic particles (shavings) can collect in the oil pan, even in a transmission that has only been in operation for few kilometers. This wear debris comes from metallic parts in the transmission which move into or against each other e.g. from disk supports which are gently impacted by disks during operation.

This wear debris collects in the oil pan and does not represent any risk to the electrohydraulic control system because the oil filter filters the particles out.

If a complaint is received, it is necessary to differentiate between this type of shaving and elongated shavings and between a "normal" pattern of wear debris and excessive wear debris accumulation. These elongated shavings are also filtered out by the filter but they are caused by a damaged component and may therefore be related to the complaint. As a result, if elongated shavings are found (3-10 mm in length) it is important to determine their origin and replace any defective components. If the replacement of components is not cost-effective, it may be necessary to replace the transmission.

We currently recommend replacing the transmission if the following damage is present:

- Oil pump has seized in housing
- Rear planetary gear set is defective
- Torque converter lockup clutch is worn (very large amount of shavings in transmission oil pan without any visible transmission defects)

The pictures on the page opposite show examples of various types of transmission damage. Naturally, the transmission can also be damaged even if no wear debris has been produced.

#### Picture 1-2

These pictures show examples of transmissions which are obviously mechanically damaged.

#### Picture 3-6

These pictures show examples of transmissions where it is not possible to conclude that the transmission is damaged based on the pictures.

Transmissions with obvious mechanical damage



Picture 1



Picture 2

Mechanical damage not visible based on pictures



Picture 3



Picture 4



Picture 5

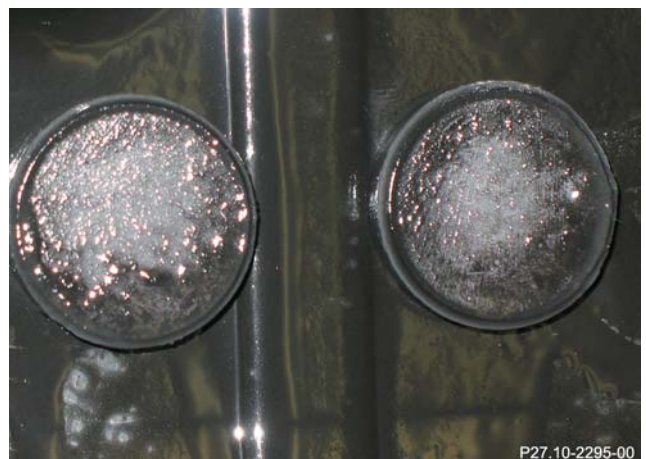

Picture 6

## Oil level

### Measuring/adjusting oil level

#### When should an oil level check be performed?

The oil level must always be checked when there are indications that the transmission may be underfilled. These include:

- Visible leaks
- After work is performed on the transmission cooling system
- If there are complaints which mainly occur when the transmission is very cold
- If there are complaints which occur on steep uphill/downhill slopes and/or during rapid cornering

It is not necessary to always check the oil level in the event of shift quality complaints.

#### Is the oil level too low if no oil flows out when the drain screw is opened?

Possibly, but not necessarily.

If the oil drain screw is removed at 45 °C as per AR27.00-P-0100W on transmissions with a sloped transmission oil pan, at least a small quantity of oil will flow out (oil that was in tube). If no further oil flows out after this small quantity, this only means that the oil level is below the top edge of the tube. If the oil level is only a few millimeters below the edge, the oil level is still OK because it is within the tolerance.

#### **i** Note

Unfortunately, there is no way of measuring the distance between the oil level and the upper edge of the tube. Experiments with bent dipsticks were not successful because they could not be read off accurately.

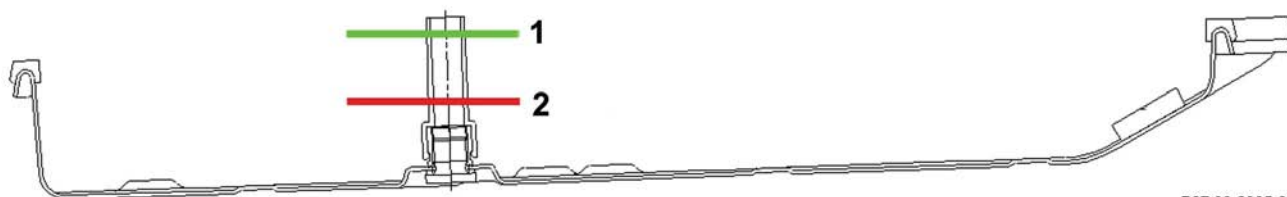

P27.00-2305-00

#### **Oil level check**

1 Oil level OK

2 Oil level not OK

It is therefore not possible to evaluate the oil level by removing the drain screw. In case of suspicion that the oil level is too low, 0.5-1 l of transmission oil must be poured into the transmission as described in AR27.00-P-0100W and then the excess oil must be drained off until only a small quantity runs out (arrow b).

It is only possible to determine the top-up quantity once this excess oil has been collected and measured.

The transmission oil level is then adjusted to the center of the tolerance range. If the oil level was previously at the OK level on the drawing, it is possible that only 0.1-0.2 l of transmission oil was added. In this case, the transmission was **not underfilled** previously even though no oil ran out.

If more than 0.3 l of oil is required to reach the state indicated by arrow b, the oil level was outside the tolerance.

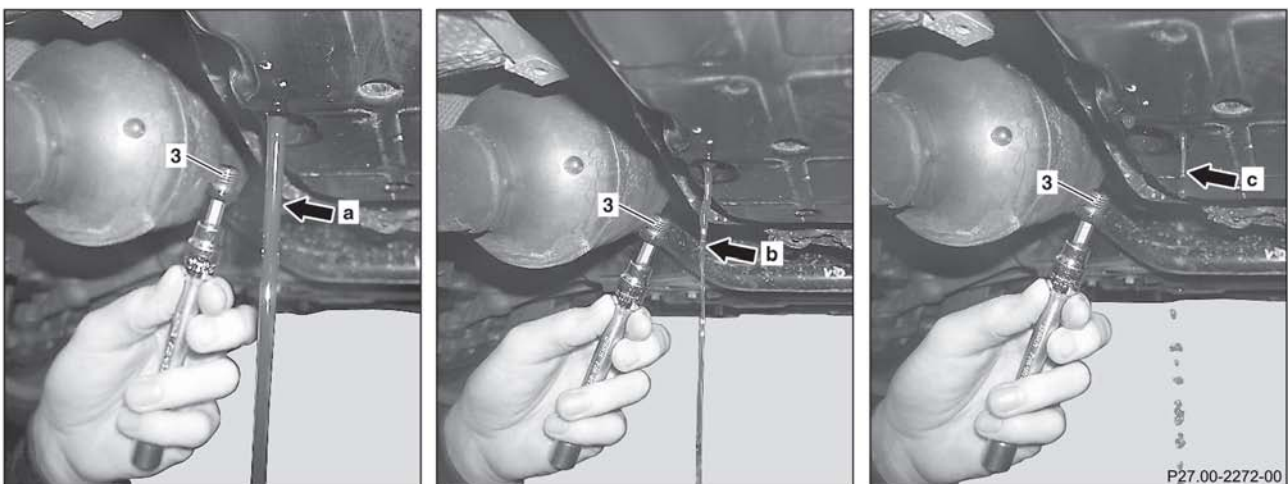

**Inspect oil level, adjust to correct level if necessary**

- a Transmission oil level is OK with this flow rate
- b Transmission oil level is OK with this flow rate

- c Transmission oil level must be corrected and re-checked with this flow rate
- 3 Oil drain screw

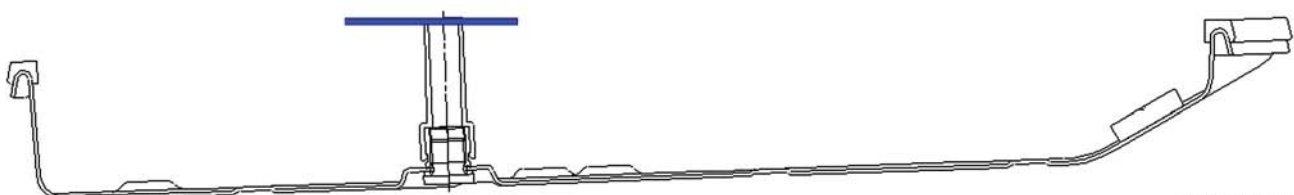

**Oil level after correction**

## Transmission 722.9

### General

This chapter provides answers to a small number of frequently asked questions. Unfortunately, it cannot cover every question and there will always be questions whose answer cannot be found here.

### Why were new oil pans, oil filters and magnets introduced?

The oil pans were first changed to a deeper version at the start of 2004 (these can be identified by the sloped rear end). The new oil pan optimizes oil supply to the transmission in all driving situations.

In addition, the oil filter has been optimized several times to improve the filtration of the transmission oil. Since the new filters also have different dimensions, the oil magnets may have to be repositioned or replaced depending on the type installed.

See SI27.56-P-0001A for more information.

### Is the correct electrohydraulic controller unit installed?

Electrohydraulic controller units (EHS) have often been replaced because the one that was installed had a different object number to that specified in EPC or WIS.

However, the documentation cannot be used to make this decision. Both the EPC and SI documents which include object numbers for installation only specify the object number which has to be installed if replacement is necessary.

This means that an EHS with a different object number which is already installed is not necessarily incorrect. Nor is it necessarily the case that a higher object number means that the component is newer.



P27.10-2138-1

*Oil pan (deeper version with slope)*

### Where can I find the number of the installed converter?

Unfortunately, the converter object number is not documented and must be read off the converter. Generally, it is possible to read off the number of an installed converter through the cutouts in the converter housing. It may be necessary to turn the motor/converter until the number is visible.

### Why does the steering wheel have to be in the straight-ahead position during torque converter lockup clutch adaptation (coolant temperature)?

During this type of adaptation, a comparison of the torque signals is performed in the control unit. All sources of interference must be eliminated to perform this comparison as accurately as possible. Since the steering angle influences the engine torque even when the vehicle is at a standstill, adaptation is only performed in the straight-ahead position (steering angle sensor).

### Why is there no beep during shift adaptation?

This topic is described in detail in the "Work tips" chapter.

### Why can't I shut off the torque converter lockup clutch?

The torque converters of transmission 722.9, especially on vehicles with diesel engine, have a very "soft" design. This means that there would be a great deal of converter slip if the torque converter lockup clutch was not engaged.

Significant converter slip also produces a great deal of heat which cannot be monitored in the converter and would cause damage.

## List of abbreviations

---

**ADA**

Application pressure adaptation

**ATF**

Automatic Transmission Fluid

**CAN**

Controller Area Network

**EHS**

Electrohydraulic controller unit

**ESP**

Electronic Stability Program

**FZA**

Fill time adaptation

**ISM**

Intelligent Servo Module

**KÜB**

Torque converter lockup clutch

**SI**

Service Information

**WIS**

Workshop Information System

<b>A</b>	
Acceleration downshift . . . . .	<b>27</b>
Acceleration downshift adaptation . . . . .	<b>29</b>
Actuators . . . . .	<b>10</b>
Adaptation	
in 3 torque windows . . . . .	<b>31</b>
of torque converter lockup clutch . . . . .	<b>31</b>
via coolant temperature . . . . .	<b>31</b>
Application pressure adaptation . . . . .	<b>26</b>
<b>C</b>	
Complaints	
about torque converter lockup clutch . . . . .	<b>21</b>
with fault codes/event codes . . . . .	<b>15</b>
without fault codes/event codes . . . . .	<b>20</b>
Shift quality . . . . .	<b>21</b>
Control unit adaptation . . . . .	<b>25</b>
Converter return flow strainer . . . . .	<b>17</b>
Customer statement	
I was no longer able to shift . . . . .	<b>8</b>
Transmission stopped shifting . . . . .	<b>8</b>
<b>D</b>	
Dealing with customer complaints . . . . .	<b>14</b>
Downshift adaptation . . . . .	<b>29</b>
<b>E</b>	
Electrohydraulic controller unit . . . . .	<b>17</b>
Eliminating complaints . . . . .	<b>15</b>
Engine torque display . . . . .	<b>30</b>
<b>F</b>	
Faults	
in control solenoid valves . . . . .	<b>18</b>
in hydraulic actuators . . . . .	<b>18, 20</b>
in rpm sensors . . . . .	<b>16</b>
in torque converter lockup clutch . . . . .	<b>16</b>
Fill time adaptation . . . . .	<b>26</b>
<b>M</b>	
Multidisk clutch . . . . .	<b>12</b>
<b>O</b>	
Oil level	
adjusting . . . . .	<b>34</b>
checking . . . . .	<b>34</b>
<b>P</b>	
Problem	
Vehicle jolted while driving . . . . .	<b>14</b>
Vehicle starts off in 1st gear even in C . . . . .	<b>14</b>
<b>S</b>	
Shift adaptation . . . . .	<b>25</b>
Shift line adaptation . . . . .	<b>25</b>
Shift line displacements . . . . .	<b>7</b>
Start-off gear . . . . .	<b>7</b>



## T

Torque converter lockup clutch . . . . .	12
Transmission	
Function . . . . .	6
Interrelationships . . . . .	6
Transmission leaks . . . . .	23
Transmission number . . . . .	24

## U

Upshifts . . . . .	27
Upshift adaptation . . . . .	28

## W

Wear debris patterns in oil pan . . . . .	32
Work tools . . . . .	23