

# Dealer Ordering Guide

**PRELIMINARY.  
DOCUMENT SUBJECT TO  
CHANGE.**



## **Mercedes-Benz MY 17 E-Class Sedan (W213)**

## **An important note about this Guide:**

The information presented in this guide is based on the most current information available and is intended for internal use only. Mercedes-Benz reserves the right to make changes at any time, without notice, to colors, materials, equipment, special specifications and models. Pricing may not yet be finalized for some models or options.

Due to variances among monitors and printers the colors that appear on your screen and printouts may not be exact.

For illustrative purposes, some images may show vehicles with European Specification.

## Revision History

Date	Changes
03/10/16	Initial release
03/11/16	Removed SiriusXM® Radio w/ Free Trial Period from stand-alone option
	Modified Premium P01 Package
04/13/16	464 – 12.3” Widescreen Instrument Cluster now available as Stand-Alone Option (no longer SPC option)
	PAF - Acoustic – Comfort Package available as Stand-Alone Option (no longer SPC option)
	322 – Sport Wheel Package now available
	235 – PARKTRONIC w/Active Parking Assist renamed to Parking Pilot
	501 – 360° Surround View Camera renamed to Surround View System
	P20 – Speed Limit Assist renamed to Speed Limit Pilot (NEW: automatic adoption of detected speed limits)
04/15/16	Updated <i>designo</i> Packages (P62 & P87)
04/19/16	Delayed availability: <i>designo</i> Packages (P62 & P87), Luxury Package (167)
04/20/16	P62 & P87 – <i>designo</i> Packages now available
	Updated Specifications - Trunk size
	Modified Stand-Alone Options
04/22/16	Modified Competitive Advantages
04/29/16	Modified MB Accessories Program (00A- Illuminated Star)
05/04/16	Delayed availability: Head-Up Display New Q03 Pkg (Premium 3 w/o Head-Up Display)
05/16/16	Modified Specification: Comparison - E350 MY16

## Revision History

Date	Changes
06/07/16	Delayed availability: Car-to-X Communication
06/10/16	Modified Specification: Acceleration for E350 MY16/ E300 & E300 4M
06/17/16	Updated DOG to correspond to Monroney Label Edits to Package Structures and Completed DOG Pricing
06/21/16	167 - Luxury Package now available 321 - Sport Package now included in Option Packages
	608 - Adaptive Highbeam Assist now available as Stand-Alone Option
	811 - Burmester® High End 3D Surround Sound System now available (only w/P01/P02/ P03 or Q03 Package)
	Updated Premium Package Pricing: P02/ P03 & Q03 Package
	Limited availability: Head-Up Display in P03 Premium Package
	Updated Specifications - Fuel Economy & Curb Weight
06/22/16	Updated Curb Weight on Specs. of E300 & E3004M
	234 - Blind Spot Assist available as Stand-Alone Option
06/23/16	536 - SiriusXM® Radio w/ Free Trial Period only available in Premium Packages (P01/P02/P03 or Q03) or as a stand-alone option
07/13/16	Delayed availability: Rear Safety Package (325)
07/20/16	Updated Information on COMAND® Navigation: NFC pairing to headunit is not standard - must have Premium P01 Package
07/27/16	Updated Stand-alone options: Heated and Ventilated Front Seats (401) (only w/ P02/ P03 or Q03 & Leather or Nappa Leather upholstery)
08/26/2016	Addition of the Mercedes AMG E43

## Table of Contents

- [Models](#)
- [Specifications](#)

### **Mercedes-Benz :**

- [What's new in MY 17](#)
- [Standard Equipment](#)
- [Paints](#)
- [Upholsteries](#)
- [Trims](#)
- [Wheels](#)
- [Option Packages](#)
- [Stand-Alone Options/Special Orders/Accessories](#)
- [Visual Equipment Differentiation](#)
- [Product Highlights](#)
- [Gallery](#)

### **Mercedes-AMG:**

- [What's new in MY 17](#)
- [Standard Equipment](#)
- [Paints](#)
- [Upholsteries](#)
- [Trims](#)
- [Wheels](#)
- [Option Packages](#)
- [Stand-Alone Options/Special Orders/Accessories](#)
- [Visual Equipment Differentiation](#)
- [Gallery](#)

## Models

	Engine	Power	Torque	MSRP	Launch
E300 (213.048)	2.0L Inline-4 Turbo Engine	241 @ 5,500	273 @ 1,300- 4,000	\$52,150	Summer 2016
E300 4M (213.049)	2.0L Inline-4 Turbo Engine	241 @ 5,500	273 @ 1,300- 4,000	\$54,650	Summer 2016
AMG E43 (213.064)	AMG-enhanced 3.0L V6 Biturbo Engine	396 @ 6,100	384 @ 2,500- 5,000	\$tbd	Winter 2016



# Specifications

	E300	E300 4MATIC	AMG E43
Engine Configuration	2.0L Inline-4 Turbo	2.0L Inline-4 Turbo	AMG-enhanced 3.0L V6 Biturbo
Power (hp)	241	241	396
Torque (lb-ft)	273	273	284
Displacement (cc)	1,991	1,991	2,996
Acceleration 0-60mph (sec)	6.2 sec (est.)	6.3 sec (est)	4.5 sec (est)
Fuel Economy (Cty/Hwy)	22 mpg / 30 mpg	22 mpg / 29 mpg	TBD
Top Speed (mph)	130	130	130 (electronically limited)
Fuel Requirement (Octane)	91	91	91
# Valves per cylinder	4	4	4
Compression	9.8:1	9.8:1	10.7:1
Transmission	9G-TRONIC Auto.	9G-TRONIC Auto.	AMG-enhanced 9G-TRONIC
Transmission Speeds	9	9	9
Drive Configuration	Rear-Wheel Drive	All-Wheel Drive	AMG Performance 4MATIC All-Wheel Drive
Standard Front Wheel (Sport)	8 J x 18	8 J x 18	8 J x 19
Standard Rear Wheel (Sport)	8 J x 18	8 J x 18	9 J x 19
Standard Front Tire Size (Sport)	245/45 R18	245/45 R18	245/40 ZR 19
Standard Rear Tire Size (Sport)	245/45 R18	245/45 R18	275/35 ZR19
Standard Tire Type	All Season	All Season	All Season
Fuel Tank Size (gallons)	17.4	17.4	23.8
Trunk Size (cubic feet)	13.1	13.1	13.1
Curb Weight (lbs)	3,792	3,891	4,145
Vehicle Length (in.)	193.8	193.8	194.6
Vehicle Width (in.) - including mirrors	81.3	81.3	81.3
Vehicle Height (in.)	57.8	57.8	57.0
Wheelbase	115.7	115.7	115.7
Track Width Front/Rear (in.)	tbd	tbd	tbd





# **E300, E300 4MATIC Ordering Guide**



## What's new: MY17 Overview

### Exterior

- All-new exterior design

### Interior

- All-new interior design

### Standard Equipment

- 9G-TRONIC Automatic Transmission
- 12.3" high-resolution COMAND® Display
- Active Brake Assist\*
- Ambient Lighting (64 colors)
- ATTENTION ASSIST®
- Auto Dimming Driver/ Rearview Mirrors
- Car-to-X Communication (*delayed availability*)
- COMAND® Navigation w/ Map Updates & Live Traffic included for 3 years
- Crosswind Assist
- DYNAMIC SELECT
- KEYLESS-START
- Power Adjustable Front Seats w/Lumbar Adjust. and 3-position Memory
- Power Folding Mirrors
- Power Tilt / Sliding Sunroof
- PRE-SAFE®
- PRE-SAFE® Sound
- Split Folding Rear Seats (40/20/40)
- Touch Control Buttons on newly designed steering wheel
- Touchpad w/ COMAND® Controller



## What's new: MY17 Overview

### Optional Equipment

- New Premium Package Structure
- New Enhanced Safety Systems within Driver Assistance Package Plus
- DRIVE PILOT including the following features:
  - Distance Pilot DISTRONIC
  - Steering Pilot
    - Active Emergency Stop Assist
    - Active Lane Change Assist
  - Speed Limit Pilot
- PRE-SAFE® Impulse Side
- Active Brake Assist w/Cross Traffic Function
- AIR BODY CONTROL Air Suspension
- Head-Up Display
- Rear Safety Package
- Warmth and Comfort Package

### Paints

- Addition of Piedmont Green Metallic
- Addition of *designo* Selenite Grey Magno

### Upholsteries

- New color options
- New *designo* upholstery packages

### Trims

- Addition of Brown Ash Wood
- Addition of *designo* Black Piano Lacquer Flowing Lines Wood
- Addition of *designo* Magnolia Flowing Lines Wood

### Wheels

- New 17", 18" and 19" wheel designs



# What's new: Premium Package Structure w/ New Optional Equipment

## MY16

### Premium 1 Package

- Rearview camera
- Ventilated Front Seats
- Harman/Kardon® Sound System
- Heated Front Seats
- Powered Rear Window Sunshade
- SiriusXM® Radio w/ Free Trial Period
- Navigation Map Updates For 3 Years
- 7" COMAND® w/ Navigation
- Power Folding Mirrors
- Split-Folding Rear Seats

**MSRP \$4,180**

**Std on MY17**

## MY17

### Premium 1 Package

- Rearview camera
- Heated Front Seats
- Parking Pilot
- NFC Wireless Charging
- KEYLESS-GO® Comfort Pkg
- Blind Spot Assist
- Burmester® Surround Sound
- SiriusXM® Radio w/ Free Trial Period

**New**

**MSRP \$3,950\***

### Premium 2 Package

- Lighting Package
- Active Multicontour Seat Pkg
- Air Balance
- Power Rear Window Sunshade

**MSRP \$7,650\***

### Premium 3 Package

- Surround View System
- Driver Assistance Pkg Plus
- Head-Up Display

**MSRP \$11,250\***



## What's new: Sport Wheel Package (322)

\$650

*Optional on Sport only*



The Sport Wheel Package includes:

- Perforated front brake discs & front brake calipers w/ "MB" lettering (U29)
- Black headliner (51U)
- Wheel choice of:
  - 18" AMG 5-Spoke Wheels (RQR)
  - 19" AMG Twin 5-Spoke Wheels (RTK)\* **(+\$500)**



RQR



RTK\*



## What's new: PRE-SAFE® Sound

*Standard on all E-Class models*

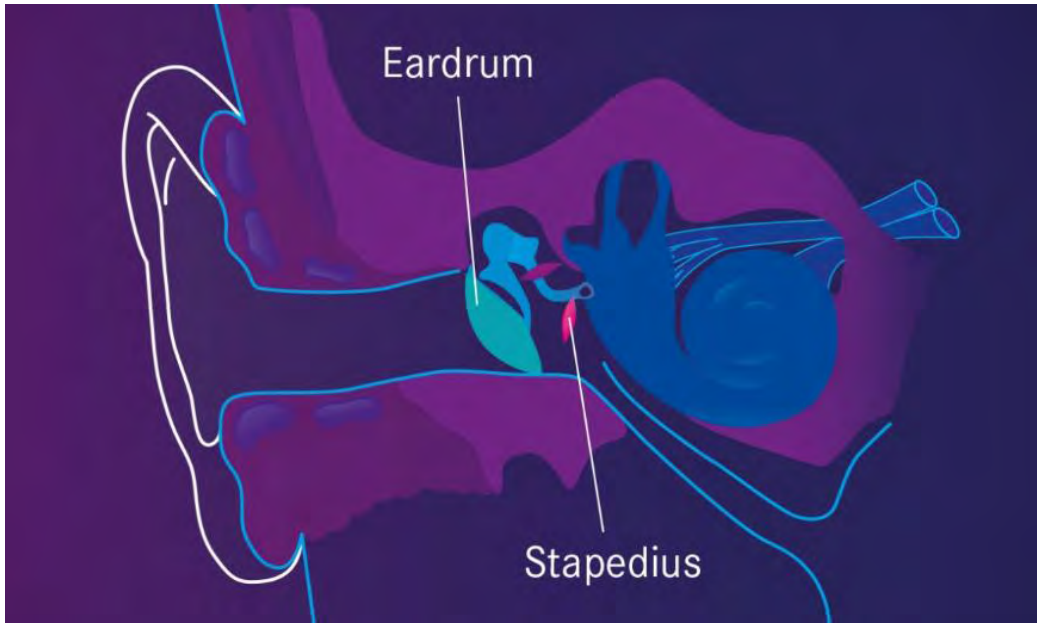

Part of PRE-SAFE, PRE-SAFE Sound is an acoustic occupant preconditioning system which can reduce the effects of the noise from an accident on the occupants hearing.

- When the PRE-SAFE system recognizes a certain dangerous situation, the onboard sound system plays a brief rushing sound, also known as 'Pink Noise', to precondition the hearing
- The natural reflex mechanism of the stapedius muscle enables the inner ear to rapidly prepare for the accident-induced high pressure sound
- Up to 40% reduction of noise exposure impact



## What's new: 531 - COMAND® Navigation (NTG 5.5)

Standard on all E-Class models



The COMAND® system at a glance:

- High-resolution 12.3-inch display
- Fast HDD navigation with 3D maps
- Map Updates & Live Traffic Included for 3 years
- WiFi hotspot provides 4G-LTE internet connection
- Smartphone Integration with Apple CarPlay™ & Android Auto
- *Bluetooth* hands-free and audio streaming
- Voice-operated control system
- Car-to-X Communication → **Delayed availability**





# What's new: Car-to-X Communication *Delayed Availability*

Standard on all E-Class models

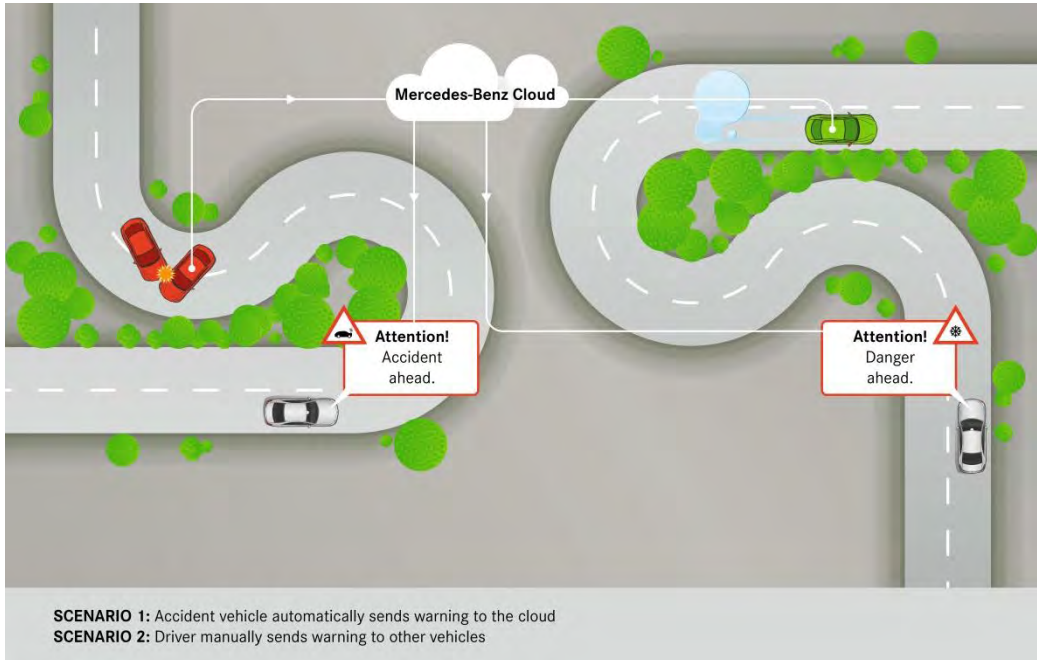

- Exchange of information with other vehicles in the surrounding area (now only from new E-Class to new E-Class) for:
  - Break-downs
  - Accidents
  - Hazardous weather (ice, fog, rain, snow, etc.)
- Driver can also send a warning manually
- Warning according to situation:
  - Icon on navigation display
  - Instrument cluster
  - Voice output



## What's new: Touch Control Buttons

*Standard on all E-Class models*



The new E-Class introduces the all new concept of Touch Control Buttons on the 3-spoke steering wheel to operate the instrument cluster and the headunit by horizontal and vertical swiping movements of the finger. The main focus is to keep the customer's hands on the steering wheel and eyes on the road.

- The instrument cluster display is operated by the left Touch Control Button
- The headunit (incl. navigation) is operated by the right Touch Control Button





## What's new: 448 – Touchpad

*Standard on all E-Class*



The functions of COMAND® navigation can be controlled intuitively via the innovative touchpad, using single or multi-finger gestures (multi-touch).

- Touchpad approx. 2.56 x 1.77 inches in size
- Additional full-fledged input option supplementing the COMAND® Controller, Touch Control Buttons on the steering wheel and voice control
- Recognizes single and multi-finger gestures (multi-touch), swiping movements and zoom gestures achieved by spreading the fingers or pinching them together
- Innovative handwriting recognition feature: Users are able to input letters, special characters and numbers in their normal handwriting, in any language available in the headunit
- 3 buttons located on the touchpad allow fast and direct operation of important functions
- Clear haptic feedback when using the touchpad or keys



## What's new: 897 - NFC Wireless Charging

*Optional on all E-Class, included in Premium Package P01*



- Pairing to the headunit via NFC
- Wireless charging of smartphones that support the Qi standard
  - For charging, place the smartphone in the front storage compartment in the center console
  - Storage compartment designed for mobile phones with a screen diagonal of up to 6 inches



## What's new: 463 – Head-Up Display *Limited availability*

*Optional on all E-Class, included in Premium Package P03*



The Head-Up Display at a glance:

- Key driver information at a glance (e.g. navigation tips, incoming calls, speed, settings for cruise control, assistance system messages) without the driver having to take their eyes off the road
- Projection of a virtual image measuring approx. 8.3 x 2.8 inches into the driver's field of vision, which appears to float around 78.7 inches in front
- Presentation of information in high-resolution and in color, making it clearly legible even on sunny days and at night
- Height position of the image, brightness and displayed content can be changed individually via a menu in the instrument cluster



## What's new: B59 - DYNAMIC SELECT

*Standard on all E-Class*



At a touch of the DYNAMIC SELECT selector, drivers can choose between comfortable, sporty, particularly sporty, and efficient driving styles, or even their own individually defined style. Parameters such as the engine, transmission and steering characteristics are adjusted according to the selected drive mode.

Choice of up to 5 different driving programs:

1. Comfort “C” standard setting: well-balanced and fuel-efficient
2. Eco “E” mode: for keeping fuel consumption as low as possible
3. Sport “S” mode: added agility and dynamism due to direct steering characteristics sporty, taut suspension tuning, spontaneous throttle response and modified shift points
4. Sport+ “S+” mode: even sportier performance, the suspension (in conjunction with AIR BODY CONTROL air suspension) and drive system have an even more dynamic setup
5. Individual mode: individual parameters can be varied as required, using the Controller and the configuration menu in the headunit



## What's new: 421 – 9G-TRONIC Automatic Transmission

*Standard on all E-Class*

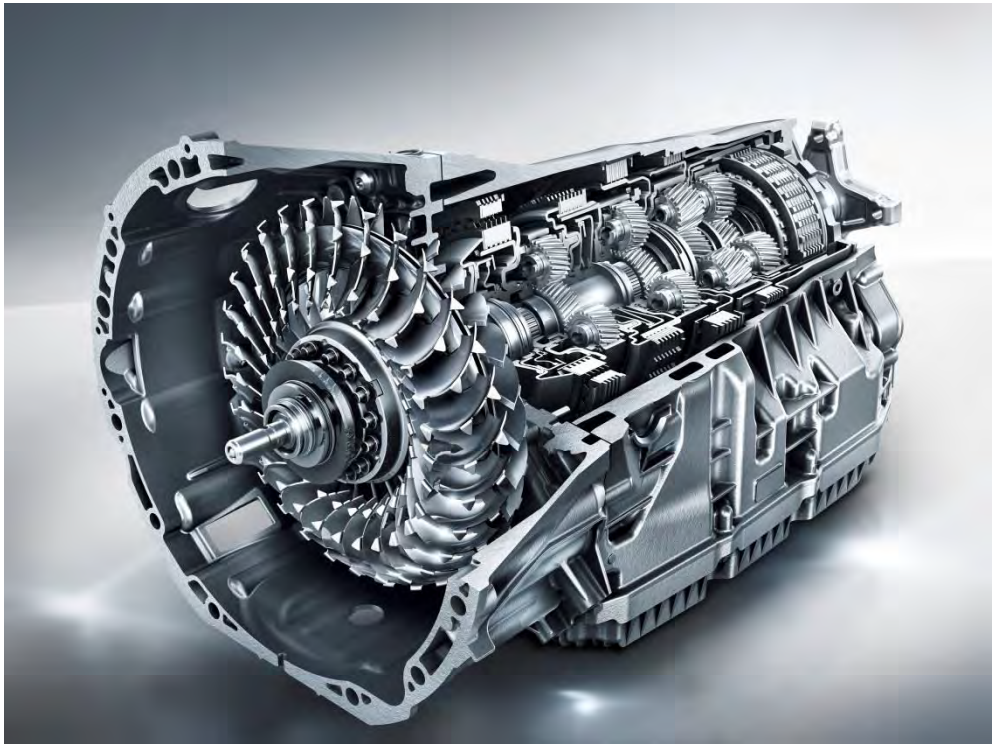

9G-TRONIC – faster, smoother, more efficient

Featuring nine forward gears, this automatic transmission takes efficiency, comfort and dynamism to a completely new level. It is the new generation 9-speed automatic transmission with hydrodynamic torque converter in the premium segment. The larger ratio range allows a reduction in engine speed. Performance remains excellent while ride comfort is enhanced and noise levels are reduced. The reduced intervals between the gears lead to faster gear changes and enhanced spontaneity and agility. At the same time, the 9G-TRONIC transmission impresses with smooth, barely perceptible gear shifting like that of a continuously variable transmission. As the 9G-TRONIC transmission is able to skip individual gears, multiple downshifts are possible for fast and powerful sprints.



# What's new: Exterior Comparison E-Class MY16 (W212) vs New E-Class MY17 (W213) - Sport

E-Class MY 2016 Exterior



New E-Class MY 2017 Exterior

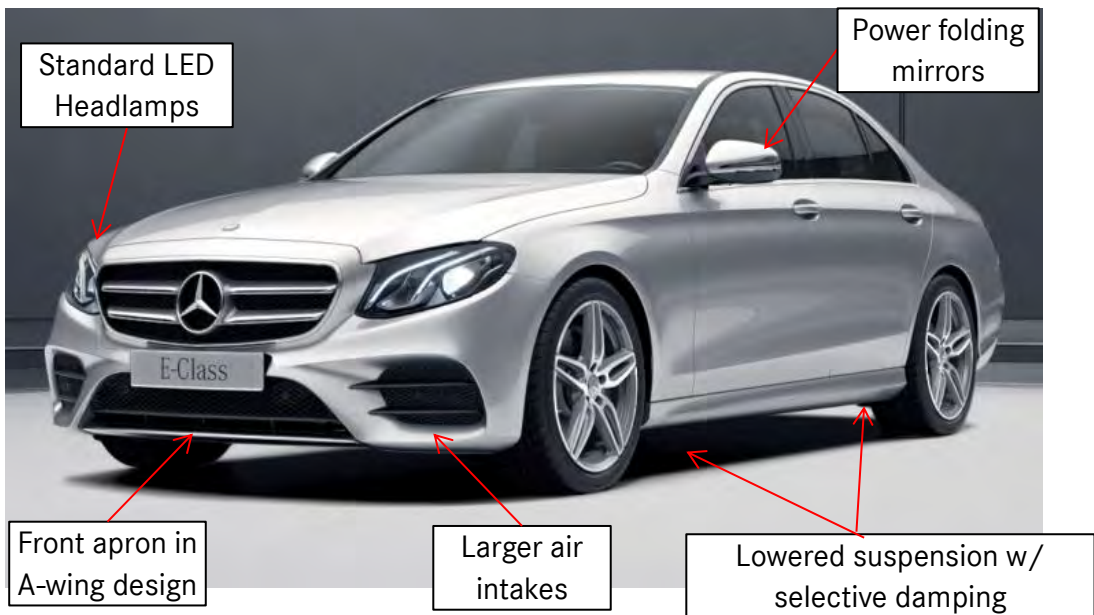

# What's new: Exterior Comparison E-Class MY16 (W212) vs New E-Class MY17 (W213) - Sport

E-Class MY 2016 Exterior



New E-Class MY 2017 Exterior

Sporty, elegant design with coupe-like elements & broad shouldered tail end

New rear taillamp design with "stardust" effect



Continuous shoulder line for a powerful, stretched body

New rear bumper design





# What's new: Exterior Comparison E-Class MY16 (W212) vs New E-Class MY17 (W213) - Sport

E-Class MY 2016 Exterior



New E-Class MY 2017 Exterior

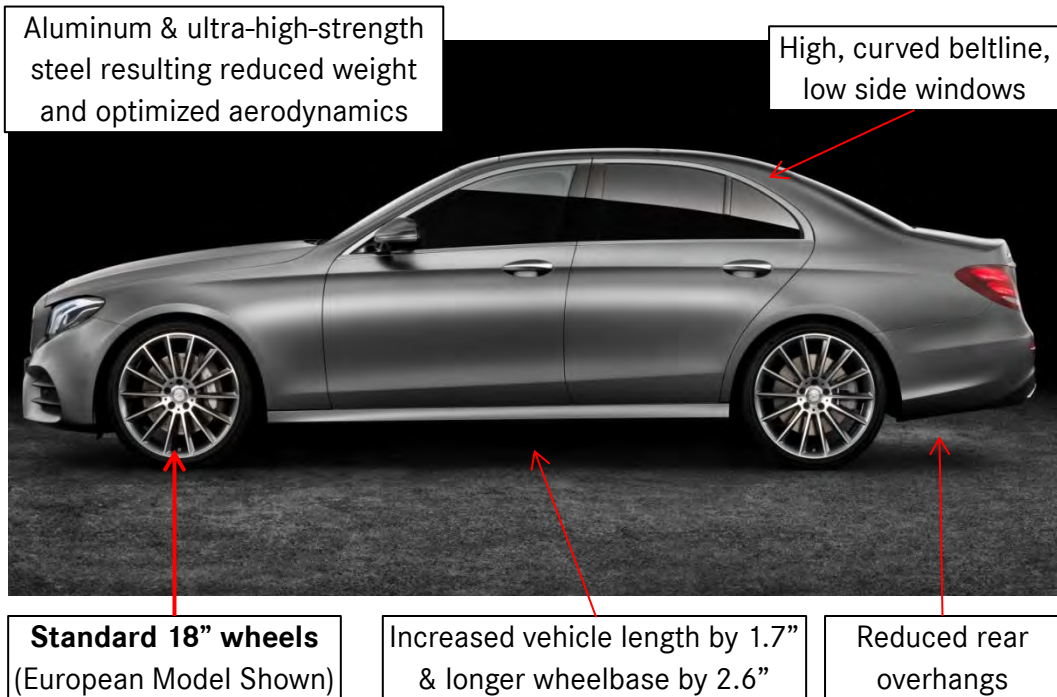



# What's new: Exterior Comparison E-Class MY16 (W212) vs New E-Class MY17 (W213) - Luxury

E-Class MY 2016 Exterior



New E-Class MY 2017 Exterior



Standard 17" wheels

Redesigned front bumper w/ chrome trim elements

# What's new: Exterior Comparison E-Class MY16 (W212) vs New E-Class MY17 (W213) - Luxury

E-Class MY 2016 Exterior



New E-Class MY 2017 Exterior



Single-exhaust system with two tailpipe trim elements integrated into the bumper

Suspension w/ selective damping



# What's new: Specifications\*

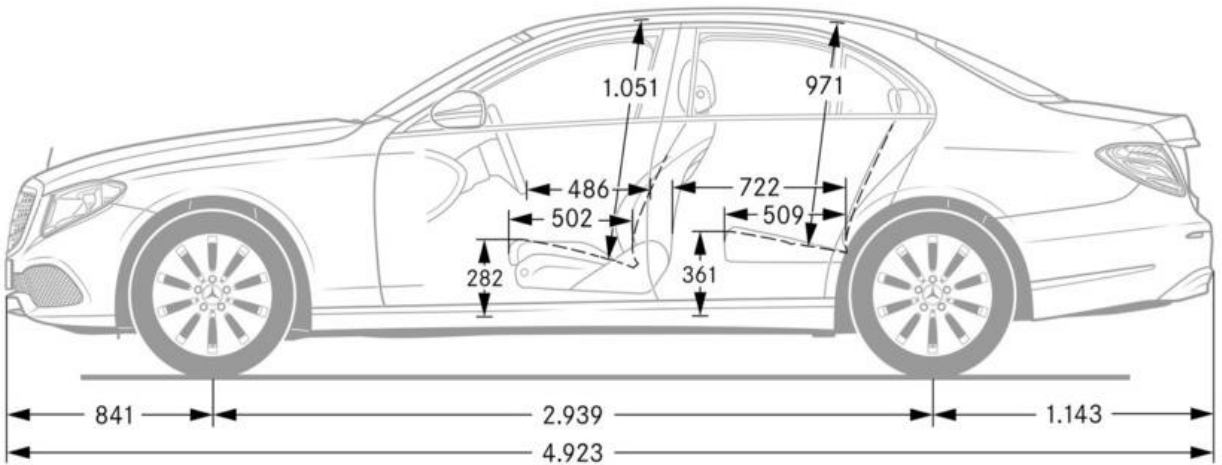
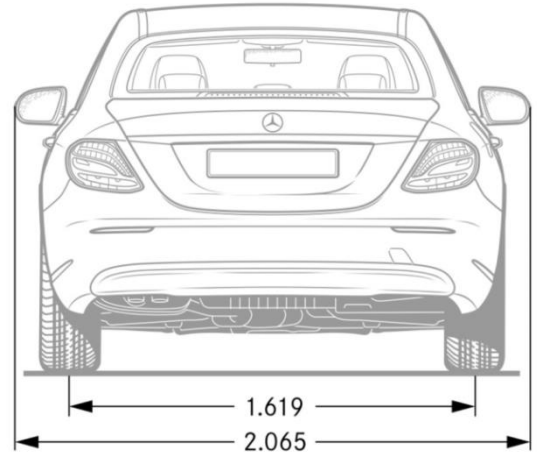
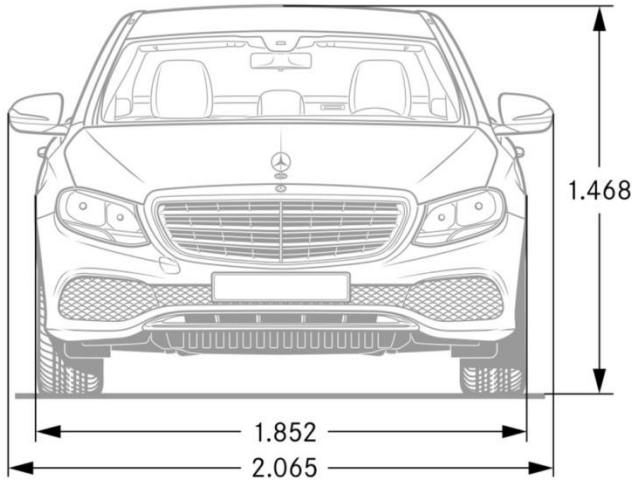

\*Values shown in meter / millimeters



# What's new: Interior Comparison E-Class MY16 (W212) vs New E-Class MY17 (W213)

E-Class MY 2016 Interior



New E-Class MY 2017 Interior\*

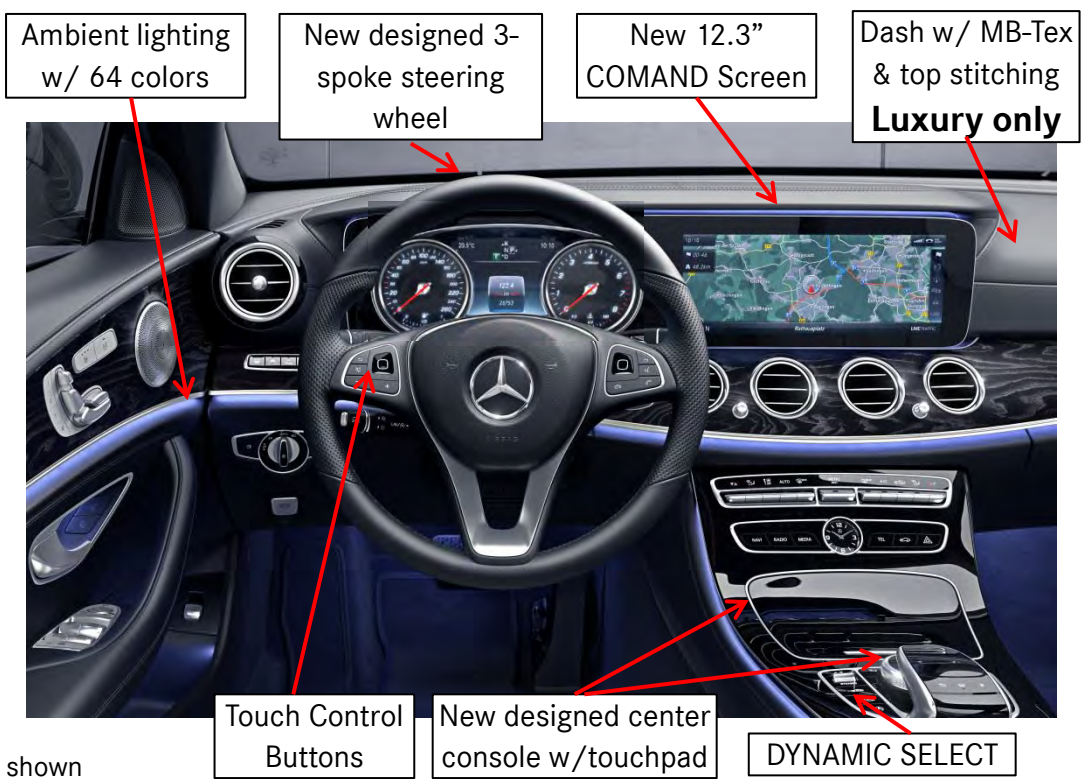

MY17 E-Class Sedan

\*Sport shown





## Standard Equipment Highlights

### Performance/Handling

- 9G-TRONIC 9-Speed Automatic Transmission
- 2.0L Inline-4 Turbo Engine (241 hp, 273 lb-ft)
- DYNAMIC SELECT driving programs

### Comfort/Convenience

- Ambient Lighting (64 colors)
- Auto-Dimming Driver-Side and Rearview Mirrors
- Bluetooth® Connectivity
- COMAND® Navigation System
- Garage Door Opener
- KEYLESS-START
- LED Headlamps
- Powered Front Seats w/ 3-Position Memory and 4-way Lumbar Support
- Power Folding Mirrors
- Power Tilt/Sliding Sunroof
- Smartphone Integration with Apple CarPlay™ & Android Auto
- Split Folding Rear Seats (40/20/40)
- Steering Wheel with Touch Control Buttons
- Touchpad w/ Central Controller
- 12.3" High-Resolution Display
- 5 Years of mbrace® Connect

### Safety/Security

- Active Brake Assist
- ATTENTION ASSIST®
- Car-to-X Communication *(Delayed availability)*
- Crosswind Assist
- LED Lights
- PRE-SAFE®
- PRE-SAFE® Sound
- Tire Pressure Monitoring System

# Paints

## Non-metallic Paints



040  
Black



149  
Polar White

## Metallic Paints<sup>1</sup>



197  
Obsidian Black

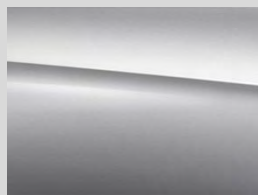

775  
Iridium Silver



796  
Dakota Brown



890  
Lunar Blue



988  
Diamond Silver

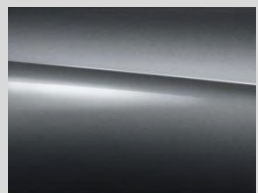

992  
Selenite Grey



997  
Piedmont Green

## designo Metallic Paints



Metallic paint with high-quality effect pigments and exclusive color shades



297  
Selenite Grey Magno<sup>2</sup>



799  
Diamond White<sup>3</sup>

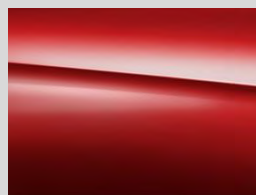

996  
Cardinal Red<sup>4</sup>

<sup>1</sup>Additional charges: \$720

<sup>2</sup>Additional charges: \$3,950

<sup>3</sup>Additional charges: \$1,515

<sup>4</sup>Additional charges: \$1,080



Preliminary pricing  
subject to change

# Upholsteries

## Standard – Sport

MB-  
Tex



121 Black  
*Crystal Grey Headliner*



124 Nut Brown/Black  
*Black Headliner*  
*(image does not reflect black headliner)*



125 Macchiato Beige / Black  
*Beige Headliner*

## Optional - Sport

Leather



201 Black<sup>1</sup>  
*Crystal Grey Headliner*



214 Nut Brown/Black<sup>1</sup>  
*Black Headliner*  
*(image does not reflect black headliner)*



215 Macchiato Beige/Black<sup>1</sup>  
*Beige Headliner*

<sup>1</sup>Additional charge on Sport: \$1,620

51U – Black Headliner

55U – Beige Headliner

58U – Crystal Grey Headliner



# Upholsteries

Preliminary pricing  
subject to change

## Standard - Luxury

MB-  
Tex



131 Black  
*Crystal Grey Headliner*



144 Nut Brown/Espresso  
*Beige Headliner*



145 Macchiato Beige /  
Espresso  
*Beige Headliner*

## Optional - Luxury

Nappa  
Leather



801 Black<sup>1</sup>  
*Crystal Grey Headliner*



814 Nut Brown /  
Espresso Brown<sup>1</sup>  
*Beige Headliner*



815 Macchiato Beige/  
Espresso Brown<sup>1</sup>  
*Beige Headliner*

<sup>1</sup>Additional charge on Luxury: \$2,990

51U - Black Headliner

55U - Beige Headliner

58U - Crystal Grey Headliner





# Upholsteries

Preliminary pricing  
subject to change

## Optional



*designo*  
Exclusive Nappa Leather



961 + P62 Pkg  
*designo* Black / Titanium Grey Pearl<sup>1</sup>  
Black *DINAMICA* Headliner  
\$4,900



975 + P87 Pkg  
*designo* Macchiato Beige / Saddle Brown<sup>1</sup>  
Macchiato Beige *DINAMICA* Headliner  
\$4,900

<sup>1</sup>Requires P02 / P03 Premium Package



## Trims

Preliminary pricing  
subject to change

### H09 – Natural Grain Brown Ash Wood



Standard on Sport  
N/C on Luxury

### 736 – Natural Grain Black Ash Wood

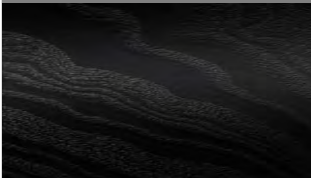

Optional on all models  
N/C

### H06 – Brown Ash Wood

new



Optional on all models  
N/C

### 731 – Burl Walnut Wood



Standard on Luxury  
N/C on Sport

### H16 – *designo* Black Piano Lacquer Flowing Lines Wood

new



Optional on all models  
\$1,300

### H26 – *designo* Magnolia Flowing Lines Wood

new



Optional on all models  
\$1,300

# Trims

Preliminary pricing  
subject to change

## 739 – Aluminum (SPC\*)

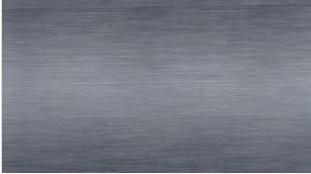

Optional on all models  
**Special Order Option Charge (\$250)**

Preliminary pricing  
subject to change

# Wheels

## Standard

## Optional

E300/4M  
Sport model



new

**R31** - 5-Spoke  
R02 & R66  
**18"**



new

**RQR** -AMG 5-Spoke  
R02 & R66  
**18"**  
(only i.c.w. Sport wheel pkg)



new

**RTK** - AMG Twin 5-Spoke  
R02 & R66  
**19"**  
(only i.c.w. Sport wheel pkg)  
**\$500**

E300/4M  
Luxury model



new

**R07** - Twin 5-Spoke  
R02 & R66  
**17"**



new

**R54** - Twin 5-Spoke  
R02 & R66  
**18"**  
**\$500**



## Option Packages

Preliminary pricing  
subject to change

### P01 – Premium 1 Package

\$3,950

*Requires 810 – Burmester® Surround Sound System (\$850 included in above price) Also available 811 Burmester® High End 3D Surround Sound System for additional \$4,550*

- 218 – Rearview camera
- 235 – Parking Pilot
- 897 – NFC Wireless Charging
- 536 – SiriusXM® Radio w/ Free Trial Period
- P17 – KEYLESS-GO Comfort Pkg code
  - 871 – Hands-Free-Access
  - 881 – Electric Trunk Closer
  - 889 – KEYLESS-GO
- 234 – Blind Spot Assist
- 873 – Heated Front Seats

### P02 – Premium 2 Package

\$7,650

*Includes all (P01) Premium 1 Package features plus:*

- P35 – Lighting Package code
  - 640 – LED Intelligent Light System
  - 608 – Adaptive Highbeam Assist
- 432 – Active Multicontour Front Seats Package w/ Massage Feature
  - 902 – Rapid Heating Functionality for Front Seats
  - 436 – Luxury Front Headrests
- P21 – Air Balance Package
- 540 – Power Rear-Window Sunshade

### P03 – Premium 3 Package

*Limited availability*

\$11,250

*Includes all (P02) Premium 2 Package features plus:*

- P44 – Parking Assist Package code
  - 501 – Surround View System
- P20 – Driver Assistance Package Plus
- 463 – Head-Up Display

### NEW: Q03 – Premium 3 Package w/o Head-Up Display

\$10,260

*Includes all (P02) Premium 2 Package features plus:*

- P44 – Parking Assist Package code
  - 501 – Surround View System
- P20 – Driver Assistance Package Plus

## Option Packages (continued)

Preliminary pricing  
subject to change

### 321 – Sport Package

N/C

- 677 – Lowered Suspension with Selective Damping
- 772 – Sport Body Styling
- Mercedes-Benz Star in Radiator Grille
- Wheel: R31 – 18” 5-Spoke Wheel, All-Season, Run-Flats

### 167 – Luxury Package

N/C

- 485 – Suspension with Selective Damping
  - Luxury Radiator Grille w/ Mercedes-Benz Star on Hood
  - U09 – Dash and Upper Door Trim in MB-Tex and top-stitching
- Wheel choice of: - R07 – 17” Twin 5-Spoke Wheel (no-cost) , All-Season, Run-Flats  
- R54 – 18” Twin 5-Spoke Wheel (**+\$500**) , All-Season, Run-Flats

### 322 – Sport wheel package (only i.c.w Sport)

\$650

- U29 – Perforated front brake discs & front brake calipers w/ ‘MB’ lettering
- 51U – Black headliner
- Sport Wheel choice of: - RQR – 18” AMG Wheel (no-cost) , All-Season, Run-Flats  
- RTK – 19” AMG Wheel (**+\$500**), All-Season, Run-Flats

### 445 – Warmth and Comfort Package

\$600

*Requires Premium Pkg. 2 (P02) **OR** Premium Pkg. 3 (P03/Q03)*

- P68 – Warmth and Comfort Package code
- 906 – Heated Armrests
- 902 – Rapid Heating Functionality for Front Seats
- 443 – Heated Steering Wheel
- 431 – Galvanized Shift Paddles



## Option Packages (continued)

Preliminary pricing  
subject to change



**P62 - *designo* Titanium Grey Pearl / Black Nappa Leather** \$4,900

- U38 - Dashboard in Nappa Leather
- U04 - *designo* floor mats
- 61U - *designo* Black DINAMICA Headliner<sup>1</sup>
- P62 - *designo* Package code

Available with all trim choices, requires 961 upholstery code

<sup>1</sup>Requires P02 or P03 Premium Package



**P87 - *designo* Macchiato Beige / Saddle Brown Nappa Leather** \$4,900

- U38 - Dashboard in Nappa Leather
- U04 - *designo* floor mats
- 65U - *designo* Macchiato Beige DINAMICA Headliner<sup>1</sup>
- P87 - *designo* Package code

Available with all trim choices, requires 975 upholstery code

<sup>1</sup>Requires P02 or P03 Premium Package



## Stand-Alone Options/Special Orders/ Accessories

Preliminary pricing  
subject to change

Stand-Alone Options		
234	Blind Spot Assist <i>Not available with P01, P02, P03 or Q03 Premium Packages</i>	\$550
218+235	Rearview Camera + Parking Pilot <i>Codes 218 &amp; 235 Not Orderable Separately</i>	\$1,050
2xx	Leather Upholstery <i>Available w/ Sport only</i>	\$1,620
325	Rear Safety Package – <b>Delayed Availability</b> <i>Incl. rear safety package code (P36), rear-side airbags (293) &amp; rear seatbelt airbags (306)</i>	\$650
401	Heated and Ventilated Front Seats <i>Requires P02, P03 or Q03 and Leather (2xx)/ Nappa Leather (8xx) upholstery Not available with heated front seats (873)</i>	\$450
413	Panorama Roof <i>Standard power tilt/ sliding sunroof (414)</i>	\$1,090
443	Heated Steering Wheel	\$250
464	12.3" Widescreen Instrument Cluster <i>Requires P03 Package</i>	\$850
489	AIR BODY CONTROL air suspension	\$1,900
536	SiriusXM® Radio w/ Free Trial Period <i>Not available w/ P01, P02, P03 or Q03 Premium Packages</i>	\$460
608	Adaptive Highbeam Assist <i>Not available with P02/P03 or Q03 Package</i>	\$250
8xx	Nappa Leather Upholstery <i>Available w/ Luxury (167) only</i>	\$2,990
873	Heated Front Seats <i>Not available with 401, P02/P03 Package or 445 Package</i>	\$750
L3D	Wood/Leather Steering Wheel <i>Requires burl walnut wood (731). N/A with 445 Package or heated steering wheel (443)</i>	\$590



## Stand-Alone Options/Special Orders/ Accessories

Preliminary pricing  
subject to change

### Stand-Alone Options

U80	115V AC Power Outlet	\$115
PAF	Acoustic – Comfort Package <i>Increased Cabin Insulation, Windshield and Side Windows with Acoustic and Heat Absorbing Membrane</i>	\$1,100

### Special Order Options (additional charge of \$250)

313	Rear Door Roller Blinds <i>Includes Code P09 Package Requires P02 and P03/Q03</i>	\$380
872	Heated Rear Seats <i>Requires one of the following heated front seat options: 873, P01, P02, P03 or 401 and leather (2xx) or nappa leather (8xx) upholstery</i>	\$620

### MB Accessories Program

00A	Illuminated Star <i>Not available w/ P03 Premium Package or 167 Luxury Package</i>	\$550
068	Wheel Locks	\$150
070	Chrome Door Handle Inserts (Set of 4)	\$100
104	Rear Spoiler	\$350
129	Accessory Styling Package (Rear & Roof Spoiler) <i>Not available w/ 104</i>	\$650
137	Comfort Box	\$300

## Visual Equipment Differentiation

### Headlights

#### LED Headlamps\* (Standard)



- All functions feature LED technology
- Excellent illumination of the road
- Integrated LED daytime running lamps with fiber optic effect
- Projector LED low-beam and reflective LED high-beam technology
- New LED taillamps featuring 72 LEDs
- Low energy consumption
- Color of emitted light more similar to that of daylight
- Much longer bulb life

#### LED Intelligent Light System\* (Included in P02 Premium Package)



All functions of the standard LED headlamps plus:

- Automatic high-beam control by Adaptive Highbeam Assist
- Automatic adaptation of headlamps to weather, lighting and driving conditions for ideal visibility in every situation
- Automatically activated cornering lights
- Active light function for significantly better illumination in bends
- Distinctive look during day and night



Preliminary pricing  
subject to change

## Visual Equipment Differentiation

### Steering Wheels

#### L3C - Standard – 3-spoke Multifunction Steering Wheel



- Standard on all models
- The all new 3-spoke steering wheel in nappa leather comes with unique Touch Control Buttons in the control panels on the left and right. The steering wheel is embossed in the center grip area.

#### L3D – Wood/leather Steering Wheel (requires 731)

\$590



- Optional on all models
- The combination of high-quality leather in the grip area and fine wood inserts at the top and bottom make this steering wheel a visual and tactical highlight.
- Only available with Burl Walnut Wood (731). N/A with heated steering wheel (443).

#### 443 – Heated Steering Wheel

\$250



- Optional on all models
- On cold days, heating of the steering wheel rim very rapidly ensures cozy temperatures of the grip area and thus also warm hands. The switch for turning the heating on and off is positioned right next to the steering wheel.
- N/A with Wood/leather steering wheel (L3D).

## Product Highlights: Active Brake Assist *(Formerly CPA PLUS)*

Standard on all models

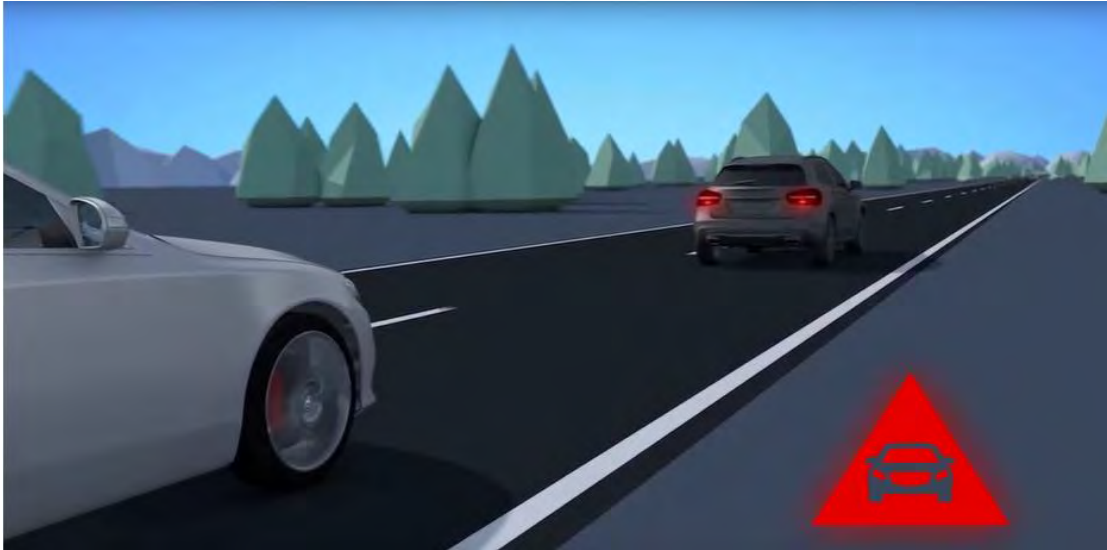

- Radar-based driving assistance system that can help prevent accidents with vehicles ahead and with crossing pedestrians or mitigate the consequences of accidents
- Combination of proximity warning, collision warning, on-demand braking assistance and autonomous braking function
- Additional audible warning if the distance diminishes rapidly
- If the driver initiates emergency braking – if necessary – increase in braking pressure by the on-demand braking assistance
- Initiation of autonomous braking if the driver fails to react
- Visual and audible warning plus almost simultaneous emergency braking if an impending collision with a **crossing pedestrian** is detected



## Product Highlights: Crosswind Assist

Standard on all models

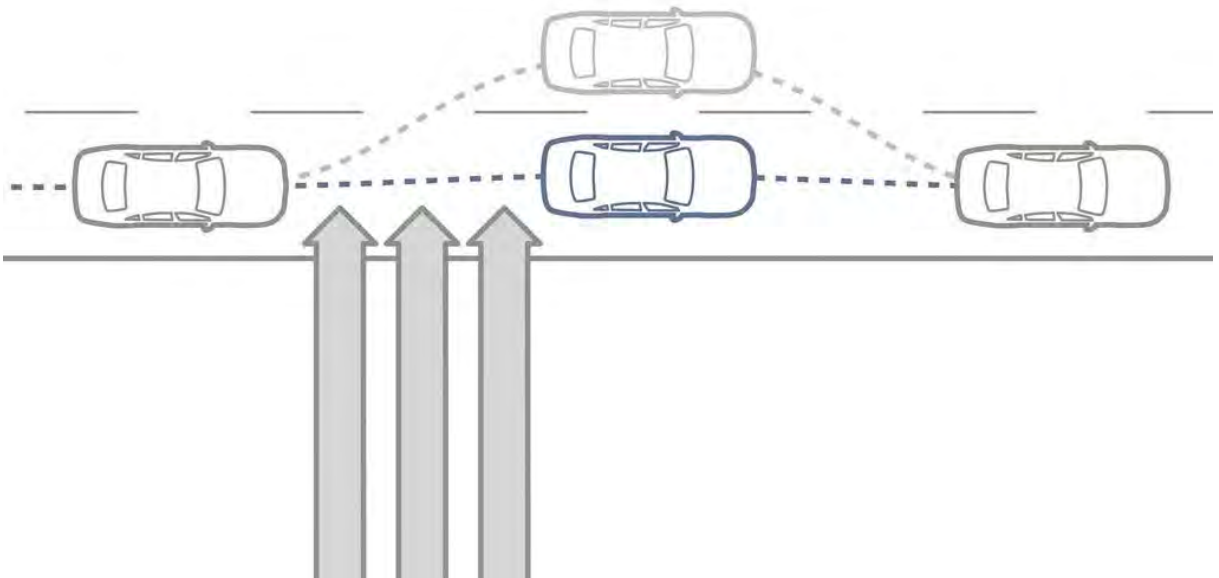

- Traditionally, strong gusts of wind may lead to sudden lateral drift of the vehicle
- Crosswind Assist aids the driver by reducing the vehicle's lateral drift substantially in windy driving conditions
- Crosswind Assist is integrated into the ESP® sensor system and enables the timely detection of gusts of crosswind
- Automatic brake intervention on the wheels on the side of the vehicle facing the wind results in a motion which counteracts the crosswind
- Crosswind Assist substantially enhances the driver's sense of control, stability and safety





## Product Highlights: AIR BODY CONTROL

Optional on all models

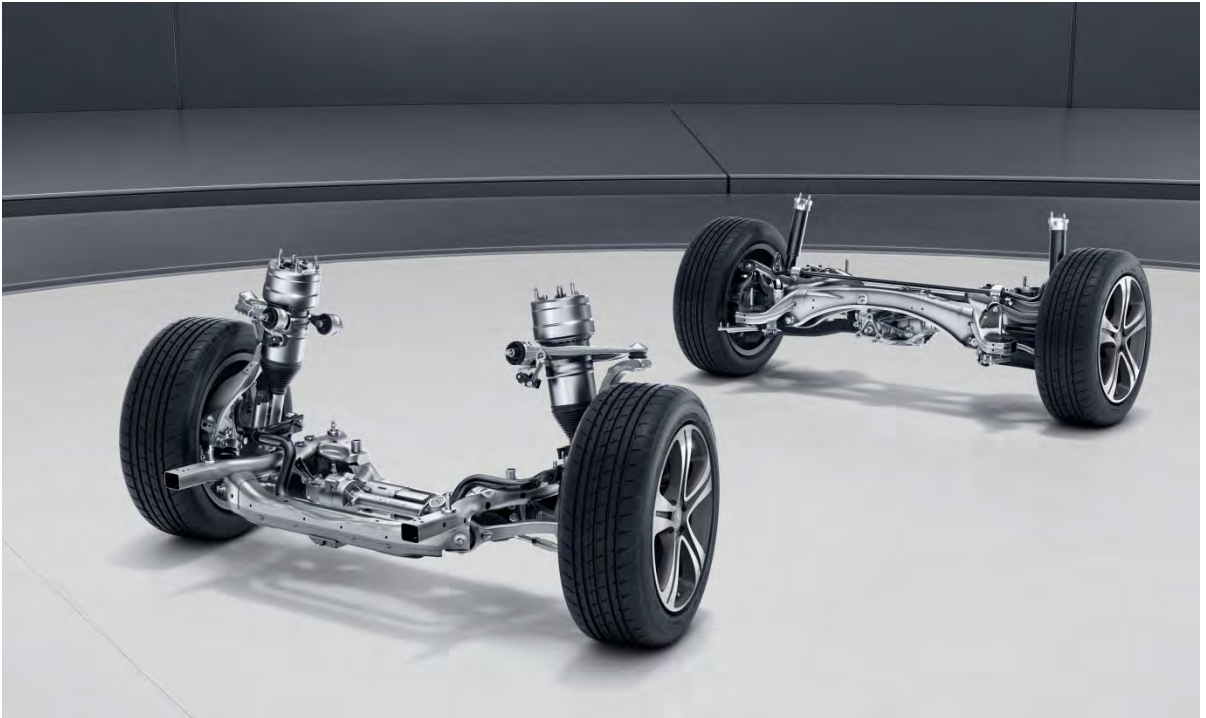

- Multi-chamber air suspension combined with continuously adjustable damping to improve ride comfort and driving dynamics
- Vehicle characteristics can be varied from comfortable through to sporty using DYNAMIC SELECT switch
- "Comfort" and "Sport" settings for a more comfortable or stiffer, sportier setup
- Constant vehicle level irrespective of load thanks to pneumatic all-round self-levelling suspension
- Suspension level can be raised for poor surfaces and is automatically lowered at high speeds, helping to reduce aerodynamic drag and further improve handling stability
- *Selective luggage compartment lowering not applicable on E300/E300 4M*

## Product Highlights: Burmester® Surround Sound System

Optional on all models – Included in P01 Premium Package



- 13 high-performance speakers precisely configured for the vehicle interior to ensure well-balanced and very dynamic music reproduction
- 9-channel DSP amplifier with a total output of 590 watts (7 x 50 W and 2 x 120 W) for maximum sound quality with very high volume reserves
- Frontbass® technology with woofers integrated into the dash for vibrant bass reproduction
- Combination of digital and analogue filter elements for the unique Burmester® "feel-good sound"
- Sound optimization for the front and rear seats
- Noise compensation (VNC)
- Sound preset: surround function to generate virtual all-round sound
- Support for popular multi-channel formats such as Dolby Digital 5.1/DTS for example, for true surround sound

## Product Highlights: Intelligent Drive - Overview

Optional on all models – Included in P03 Premium Package



“Intelligent Drive” is a gateway to a more autonomous & accident-free driving which increases safety for all drivers on the road. The following lists all features that are available with the all new E-Class:

- **DRIVE PILOT** (includes Distance Pilot DISTRONIC, Steering Pilot, Active Lane Change Assist, Active Emergency Stop Assist, and Speed Limit Pilot)
- **Active Brake Assist with Cross-Traffic Function**
- **Evasive Steering Assist**
- **PRE-SAFE® PLUS**
- **PRE-SAFE® Impulse Side**
- Active Lane Keeping Assist
- Active Blind Spot Assist



## Product Highlights:

# Intelligent Drive – DRIVE PILOT

Optional on all models – Included in P03 Premium Package

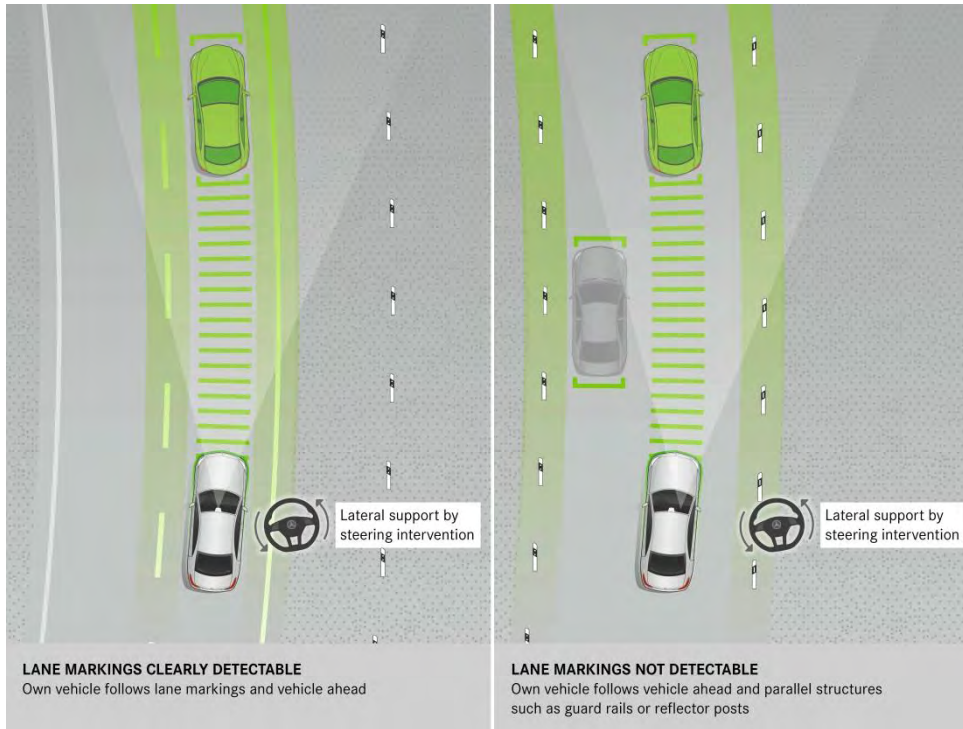

- Steering Pilot generates steering torque which helps the driver to keep the vehicle in the center of its lane (straight roads and slight bends), taking its guidance from vehicles ahead and road lane markings
- Active Lane Change Assist helps the driver with changing lanes by means of steering torque when the driver initiates the change by activating the turn indicator and the system does not detect another vehicle in the adjacent lane
- Extended tolerance for the hands-off warning of Steering Pilot with intelligent hands-on detection
- Active Emergency Stop Assist brakes the vehicle to a controlled stop if the system detects that the driver is permanently distracted or is no longer able to operate the vehicle
- Distance Pilot DISTRONIC maintains the selected distance from the vehicle in front, and works in the speed range from 0 – 130 mph, also reacting to stationary vehicles at low speeds

## Product Highlights:

### Intelligent Drive – Active Brake Assist with Cross-Traffic Function

Optional on all models – Included in P03 Premium Package

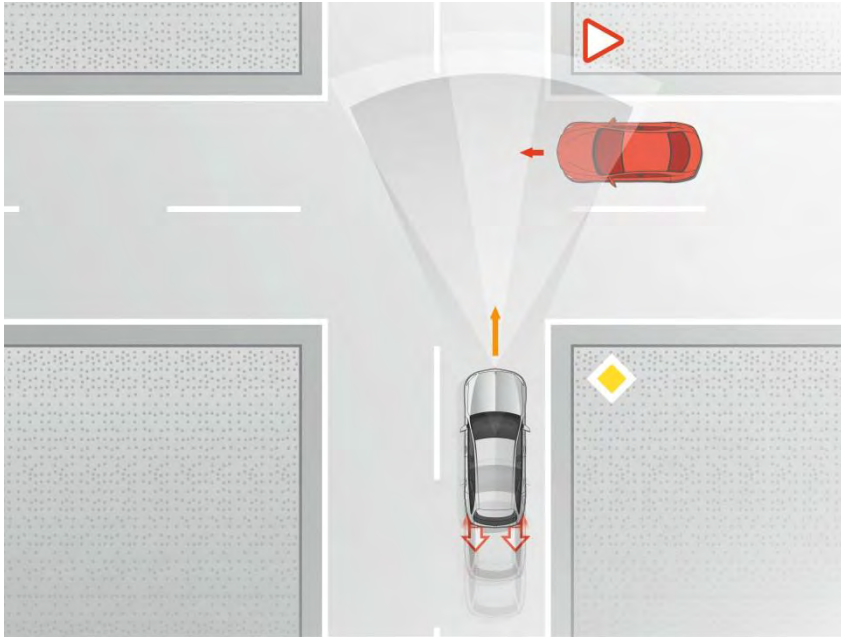

- The system is able to reduce the risk of collisions and accidents at road junctions
- Monitoring of traffic situation ahead of the vehicle by means of radar sensors and stereo multipurpose cameras
- Vehicles travelling ahead are detected up to a speed of 130 mph
- Crossing traffic and bicyclists are registered up to a speed of 45 mph, as well as pedestrians who are stationary or moving slowly in the path of the vehicle
- When danger of a collision is detected, the system gives a visual and audible warning and brakes
- If the driver firmly applies the brakes, the system calculates the brake pressure that would be needed to prevent a collision
- If a collision cannot be prevented, the impact speed is reduced as much as possible by emergency braking



## Product Highlights: Intelligent Drive – Evasive Steering Assist

Optional on all models – Included in P03 Premium Package

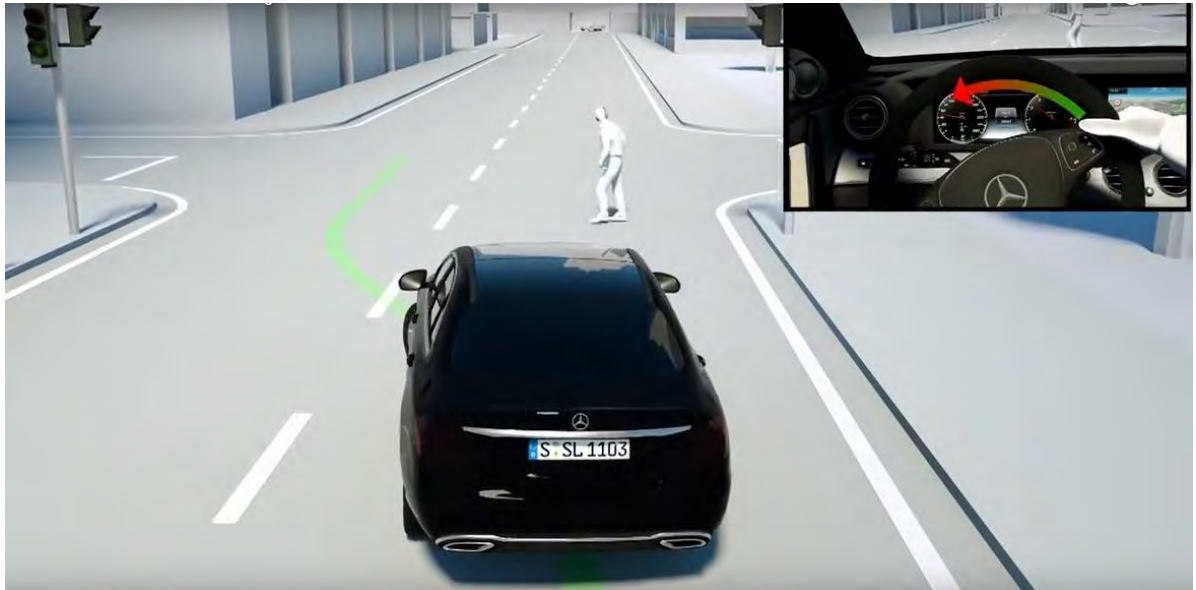

- When the driver deliberately or instinctively performs an evasive maneuver in a dangerous situation (pedestrian crossing the street), Evasive Steering Assist provides assistance by adding precisely calculated steering torque to support the movement of the steering wheel
- This helps the driver to avoid a pedestrian in a controlled manner while subsequently facilitating the movement of the vehicle to allow the situation be negotiated safely

## Product Highlights:

### Intelligent Drive – PRE-SAFE® Impulse Side

Optional on all models – Included in P03 Premium Package

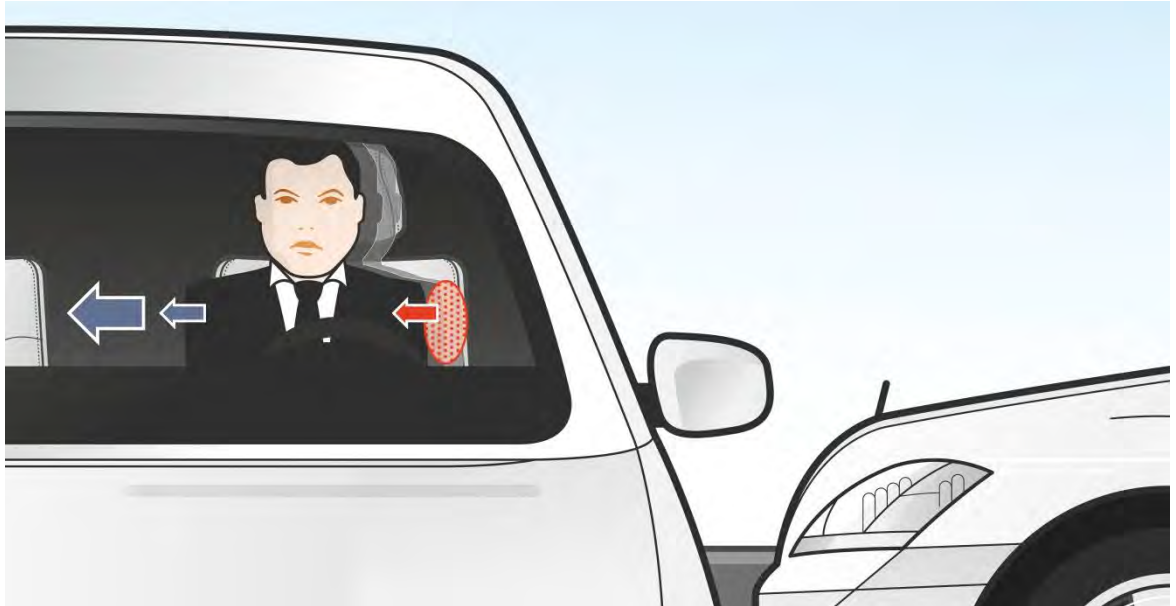

- PRE-SAFE® Impulse Side initiates preventative protective measures against an impending side impact, supplementing the measures taken by PRE-SAFE® and PRE-SAFE® PLUS
- In the event of a side impact, PRE-SAFE® Impulse Side can have a positive effect by increasing the distance between the occupant and the door, and at the same time reducing the relative speeds between the side structure and the occupant's torso
- In the event of a recognized, unavoidable side collision, the system can give the driver or front passenger a slight push towards the center of the vehicle on the side facing the impact
- This lateral impulse is initiated by very rapid inflation of an air chamber in the seat bolster

# Gallery

## New Standard Key Design



## Standard KEYLESS-START





# Gallery

*designo* Black/Titanium Grey Peal (P62)



*designo* Macchiato Beige / Saddle Brown (P87)



# Gallery

Ambient Lighting w/ 64 colors (877)



Ambient Lighting w/ 64 colors (877)





# Gallery

Optional Panorama roof (413)



Optional Wood/leather steering wheel (L3D)





# AMG E43 Ordering Guide

# What's new: MY17 Overview

## Optional Equipment

- New Premium Package Structure
- New Enhanced Safety Systems within Driver Assistance Package Plus
- DRIVE PILOT including the following features:
  - Distance Pilot DISTRONIC
  - Steering Pilot
    - Active Emergency Stop Assist
    - Active Lane Change Assist
  - Speed Limit Pilot
- PRE-SAFE® Impulse Side
- Active Brake Assist w/Cross Traffic Function
- Head-Up Display
- Rear Safety Package
- AMG Night Package
- AMG Carbon Fiber Exterior Package

## Paints

- Addition of Piedmont Green Metallic
- Addition of *designo* Selenite Grey Magno

## Upholsteries

- New color options

## Trims

- Addition of AMG Carbon Fiber
- Addition of Metal Weave
- Addition of Brown Ash Wood

## Wheels

- New 19" and 20" AMG wheel designs



## Standard Equipment Highlights

### Performance/Handling

- AMG-enhanced 9G-TRONIC Transmission
- AMG-enhanced 3.0L V6 Biturbo Engine (396 hp, 384lb-ft)
- AMG Sport Suspension based on AIR BODY CONTROL
- AMG DYNAMIC SELECT driving programs
- AMG Performance 4MATIC with rear wheel bias (31%/69%)

### Comfort/Convenience

- Ambient Lighting (64 colors)
- Auto-Dimming Driver-Side and Rearview Mirrors
- COMAND® Navigation System
- KEYLESS-START & KEYLESS-GO
- Heated Front Seats
- LED Headlamps
- Rearview Camera
- Parking Pilot
- Power Folding Mirrors
- Power Tilt/Sliding Sunroof
- Smartphone Integration with Apple CarPlay™ & Android Auto
- SIRIUS XM Satellite Radio
- NFC Wireless Charging
- Split Folding Rear Seats (40/20/40)
- Steering Wheel with Touch Control Buttons
- Touchpad w/ Central Controller
- Dual 12.3" High-Resolution Display
- 5 Years of mbrace® Connect

### Safety/Security

- Active Brake Assist
- ATTENTION ASSIST®
- Crosswind Assist
- PRE-SAFE® & PRE-SAFE® Sound
- Tire Pressure Monitoring System

# Paints

## Non-metallic Paints



040  
Black



149  
Polar White

## Metallic Paints<sup>1</sup>



197  
Obsidian Black

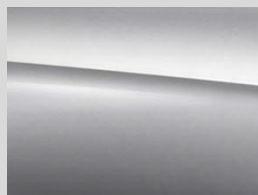

775  
Iridium Silver



796  
Dakota Brown



890  
Lunar Blue



988  
Diamond Silver

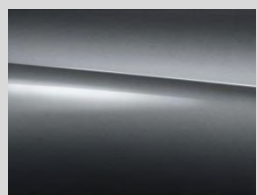

992  
Selenite Grey



997  
Piedmont Green

## designo Metallic Paints

Metallic paint with high-quality effect pigments and exclusive color shades



996  
Cardinal Red<sup>2</sup>



799  
Diamond White<sup>3</sup>



297  
Selenite Grey Magno<sup>4</sup>

<sup>1</sup>Additional charges: \$tbd

<sup>2</sup>Additional charges: \$tbd

<sup>3</sup>Additional charges: \$tbd

<sup>4</sup>Additional charges: \$tbd





# Upholsteries

## AMG E 43

Nappa Leather



821 Black with Red  
Stitching



861 Black



864 Chestnut Brown







865 Macchiato Beige

Upholstery Code	821 Black Leather w/ Red Stitching	861 Black Leather	864 Chestnut Brown Leather	865 Macchiato Beige Leather
Floor Mats	Black	Black	Black	Black
Dashboard	Black w/ Red Stitching	Black	Black	Black
Seat Belts	Red or Black	Black	Black	Black
Steering Wheel	Black	Black	Black	Black
Headliner	Black	Black	Black	Black



# Trims

Preliminary pricing  
subject to change

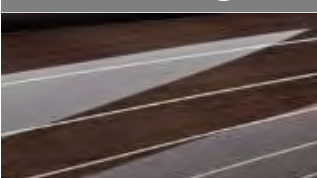
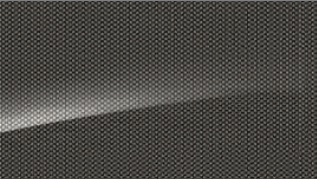
<b>H09 – Natural Grain Brown Ash Wood</b>	
	Optional
<b>736 – Natural Grain Black Ash Wood</b>	
	Optional
<b>H06 – Brown Ash Wood</b> <span style="float: right; background-color: #00AEEF; color: white; padding: 2px 5px;">new</span>	
	Optional
<b>H 16 – <i>designo</i> Black Piano Lacquer Flowing Lines Wood</b> <span style="float: right; background-color: #00AEEF; color: white; padding: 2px 5px;">new</span>	
	Optional
<b>H26 – <i>designo</i> Magnolia Flowing Lines Wood</b> <span style="float: right; background-color: #00AEEF; color: white; padding: 2px 5px;">new</span>	
	Optional
<b>H64 – Metal Weave</b> <span style="float: right; background-color: #00AEEF; color: white; padding: 2px 5px;">new</span>	
	Optional



# Trims

Preliminary pricing  
subject to change

## 739 – Aluminum

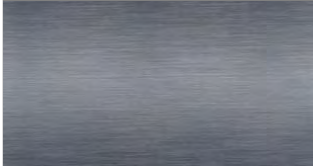

Standard

## H73 – AMG Carbon Fiber



Optional

Only with 732 – AMG Carbon Fiber Middle Console



# Wheels

## Standard

## Optional

AMG E 43



RTE - AMG Twin 5 - Spoke Wheels w/ Black Accents  
R02, R66  
**19"**



RTN - AMG Twin 5-Spoke Wheels  
R01, R66  
**20"**  
**\$tbd**



RTO - AMG Twin 5-Spoke Wheels w/ Black Accents  
R01, R66  
**20"**  
**\$tbd**



RVQ - AMG Multi-Spoke Wheels  
R01, R66  
**20"**  
**\$tbd**



RVR - AMG Multi-Spoke Wheels w/ Black Accents  
R01, R66  
**20"**  
**\$tbd**



# Option Packages

Preliminary pricing  
subject to change

## P01 – Premium 1 Package Standard

*Requires 810 – Burmester® Surround Sound System.*

*811 Burmester® High End 3D Surround Sound System also available for additional \$4,550*

- 218 – Rearview camera
- 235 – Parking Pilot
- 897 – NFC Wireless Charging
- 536 – SiriusXM® Radio w/ Free Trial Period
- P17 – KEYLESS-GO Comfort Pkg code
  - 871 – Hands-Free-Access
  - 881 – Electric Trunk Closer
  - 889 – KEYLESS-GO
- 234 – Blind Spot Assist
- 873 – Heated Front Seats

## P02 – Premium 2 Package \$TBD

*Includes all (P01) Premium 1 Package features plus:*

- P35 – Lighting Package code
  - 640 – LED Intelligent Light System
  - 608 – Adaptive Highbeam Assist
- 432 – Active Multicontour Front Seats Package w/ Massage Feature
  - 902 – Rapid Heating Functionality for Front Seats
- P21 – Air Balance Package
- 540 – Power Rear-Window Sunshade
- 902 – Heated Front Seats Plus

## P03 – Premium 3 Package \$TBD

*Includes all (P02) Premium 2 Package features plus:*

- P44 – Parking Assist Package code
  - 501 – Surround View System
- P20 – Driver Assistance Package Plus
- 463 – Head-Up Display





## Option Packages (continued)

Preliminary pricing  
subject to change

### 313 – Manual Rear Sunshade Package

\$TBD

- P09 – Sunshade Protection Package Code
- 313 – Manual Rear Side Window Sunshade

### 325 – Rear Safety Package

\$TBD

- P36 – Rear Safety Package Code
- 253 – Rear Side Airbags
- 306 – Rear Seat Belt Airbags

### 521 – AMG Night Package

\$TBD

- P55 – AMG Night Package

*AMG front apron with front splitter, mountings on the louvres of the outer air intakes & AMG rear apron in high-gloss black, black chrome-plated twin tailpipe trim elements.*

*Note: Can be combined with Exterior Carbon Fiber Package (773PKG)*

### 773 – Exterior Carbon Fiber Package

\$TBD

- B28 – AMG Carbon Fiber Package

*Exterior mirror housings & rear spoiler lip in carbon fiber.*

*Note: Can be combined with the AMG Night Package (521)*

### PAF – Acoustic Comfort Package

\$TBD

- PAF – Acoustic Comfort Package Code
- 596 – Infrared Glass

*Increased Cabin Insulation, Windshield and Side Windows with Acoustic and Heat Absorbing Membrane*



# Stand-Alone Options/Special Orders/ Accessories

Preliminary pricing  
subject to change

## Stand-Alone Options

261	Elimination of Engine Badge on Front Fender	<b>\$TBD</b>
401	Heated and Ventilated Front Seats <i>Requires P02, or P03</i>	<b>\$450</b>
413	Panorama Roof	<b>\$1,090</b>
811	Burmester High-End 3D Surround Sound System	<b>\$4,550</b>
L6I	AMG Performance Steering Wheel with DINAMICA inserts	<b>\$TBD</b>
872	Heated Rear Seats	<b>\$TBD</b>
U17	Black Seat Belts <i>Optional with Upholstery 821 – Black w/ red stitching</i>	<b>\$0</b>
U80	115V AC Power Outlet	<b>\$115</b>

## VPC Installed Accessories

00A	Illuminated Star <i>Not available w/ P03 Premium Package or 167 Luxury Package</i>	<b>\$550</b>
068	Wheel Locks	<b>\$150</b>
070	Chrome Door Handle Inserts (Set of 4)	<b>\$100</b>
137	Comfort Box	<b>\$300</b>



# Visual Equipment Differentiation

## Steering Wheels

### L5C – Multifunction Sport Steering Wheel in Nappa Leather



- Standard on the E43
- The 3-spoke multifunction sports steering wheel in black nappa leather, with flattened bottom section, heavily embossed in the grip area, with steering wheel gearshift paddles and steering wheel trim in galvanized silver chrome, has a touch control button and 4 buttons in each of the left and right control pads.

### L6I – AMG Performance Steering Wheel w/DINAMICA inserts

\$TBD



- Optional on the E43
- For an even better grip during sporty maneuvers, the grip area on the AMG Performance steering wheel in nappa leather is finished in DINAMICA microfiber. The sporty design is completed by silver-colored aluminum shift paddles and a 12-o'clock marking.



# Visual Equipment Differentiation

## Brakes

### Silver Brake Calipers with Black Lettering

Standard



- E43 only
- 4-piston front and single piston rear calipers



# Gallery

AMG E43 w/ RTE Wheels



European Model Shown

AMG E43 w/ RTE Wheels



European Model Shown