

- Parts list -

Mode	BM mode	Market	
VIN/mod. des.	WDD2130481A382846	BM overview	E 300
VIN	WDDZF4JB3JA382846	Catalog	J02
Assortment class	PC	Group	88 ATTACHMENT PARTS
		Sub-group	015 FRONT FENDER

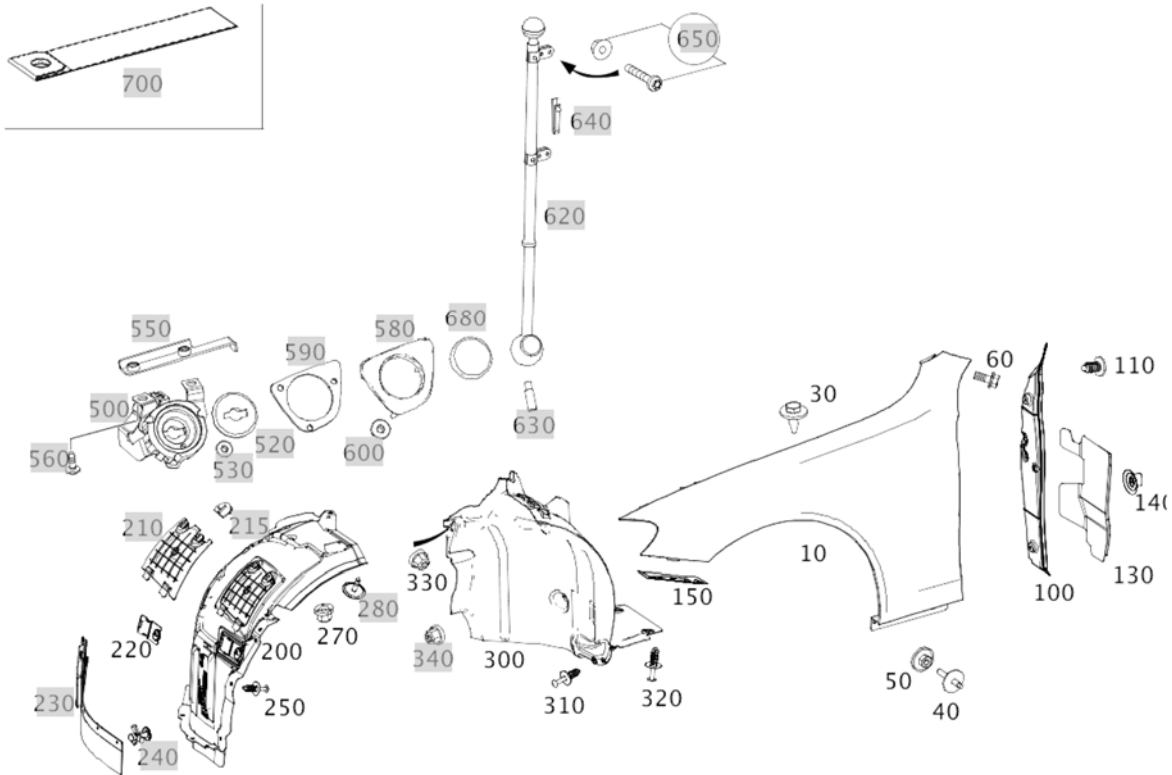















Copyright 2020-02-29 Daimler AG

Image ID: drawing_B88015000266

Item	Part number	Designation/additional information	Qty
10	A 213 880 01 18	FENDER FRONT LEFT Code: -(M177/700); [557] NOTE: BRAND SIGNATURE IS VISIBLE FOR CUSTOMER Fault location 88A01	1
10	A 213 880 00 18	FENDER FRONT RIGHT Code: -(M177/700); [557] NOTE: BRAND SIGNATURE IS VISIBLE FOR CUSTOMER Fault location 88N01	1
30	A 001 990 67 36	SCREW FOR FENDER AT TOP LEFT	4

Item	Part number	Designation/additional information	Qty
30	A 001 990 67 36	SCREW FOR FENDER AT TOP RIGHT	4
40	A 211 990 00 21	SCREW FOR FENDER AT BOTTOM LEFT; M6X44.5 Replaced by: A 099 990 00 14	2
40	A 099 990 00 14	STUD BOLT FOR FENDER AT BOTTOM LEFT Replaces: A2119900021	2
40	A 211 990 00 21	SCREW FOR FENDER AT BOTTOM RIGHT; M6X44.5 Replaced by: A 099 990 00 14	2
40	A 099 990 00 14	STUD BOLT FOR FENDER AT BOTTOM RIGHT Replaces: A2119900021	2
50	A 414 990 00 51	NUT FOR FENDER AT BOTTOM LEFT; M6	2
50	A 414 990 00 51	NUT FOR FENDER AT BOTTOM RIGHT; M6	2
60	N 910105 006023	HEXAGON HEAD BOLT LEFT FRONT FENDER, REAR; M6X16	1
60	N 910105 006023	HEXAGON HEAD BOLT RIGHT FRONT FENDER, REAR; M6X16	1
100	A 213 889 01 25	COVER, FENDER LEFT Replaced by: A 213 889 03 00  Fault location 88A07	1
100	A 213 889 03 00	COVER, FENDER LEFT Replaced by: A 213 889 00 00 Replaces: A2138890125  [414] THE OLD PART MUST NO LONGER BE INSTALLED  Fault location 88A07	1
100	A 213 889 00 00	COVER, FENDER LEFT Replaces: A2138890300 Replaces: A2138890125  Fault location 88A07	1
100	A 213 889 00 25	COVER, FENDER RIGHT Replaced by: A 213 889 04 00  Fault location 88N07	1
100	A 213 889 04 00	COVER, FENDER RIGHT Replaced by: A 213 889 05 00 Replaces: A2138890025  [414] THE OLD PART MUST NO LONGER BE INSTALLED  Fault location 88N07	1
100	A 213 889 05 00	COVER, FENDER RIGHT Replaces: A2138890400 Replaces: A2138890025  Fault location 88N07	1
110	A 002 997 33 86	COVER PLUG LEFT COVERING	3
110	A 002 997 33 86	COVER PLUG RIGHT COVERING	3

Item	Part number	Designation/additional information	Qty
130	A 213 885 01 37	ABSORBER TO FENDER LEFT	1
130	A 213 885 00 37	ABSORBER TO FENDER RIGHT	1
140	A 000 998 48 85	SPREADER NUT RIGHT ABSORBER	1
150	A 213 889 01 95	INTERMEDIATE LAYER BETWEEN FENDER, LEFT ANDBUMPER  Fault location 69C01	1
150	A 213 889 02 95	INTERMEDIATE LAYER BETWEEN FENDER, RIGHT ANDBUMPER  Fault location 69R01	1
200	A 238 690 15 03	WHEEL HOUSE COVERING LEFT FRONT FENDER  Code: (FW/FV/(FS+-M035))+-(613/620/700/M177);  Fault location 88A05	1
200	A 238 690 16 03 	WHEEL HOUSE COVERING RIGHT FRONT FENDER  Code: (FW/FV/(FS+-M035))+-(613/620/700/M177);  Fault location 88N05	1
220	A 213 690 91 02 	* MAINTENANCE FLAP LEFT FRONT	1
220	A 213 690 91 02 	* MAINTENANCE FLAP RIGHT FRONT	1
250	A 124 990 04 92	EXPANSION RIVET FRONT COVER TO BUMPER LINING, LEFT; 6.5X18	3
250	A 124 990 04 92	EXPANSION RIVET FRONT COVER TO BUMPER LINING, RIGHT; 6.5X18	3
270	A 000 990 28 62	PLASTIC NUT FRONT COVER TO SHELL, LEFT	2
270	A 000 990 28 62	PLASTIC NUT FRONT COVER TO SHELL, RIGHT	2
300	A 238 691 17 00	WHEEL HOUSE COVERING LEFT FRONT FENDER  Code: -(M035/M177/700);	1
300	A 238 691 10 00	WHEEL HOUSE COVERING RIGHT FRONT FENDER  Code: (M256/M264/M274)+-700;	1
310	A 124 990 04 92	EXPANSION RIVET LEFT REAR COVER TO LONGITUDINAL MEMBER PANEL; 6.5X18	2
310	A 124 990 04 92	EXPANSION RIVET RIGHT REAR COVER TO LONGITUDINAL MEMBER PANEL; 6.5X18	2
320	A 124 990 04 92	EXPANSION RIVET LEFT REAR COVER TO UNDERFLOOR PANELING; 6.5X18  Plant information	2
320	A 124 990 04 92	EXPANSION RIVET RIGHT REAR COVER TO UNDERFLOOR PANELING; 6.5X18  Plant information	2
330	A 000 990 28 62	PLASTIC NUT REAR COVER TO SHELL, LEFT  Code: -M177;	3
330	A 000 990 28 62	PLASTIC NUT COVERING REAR TO SHELL, RIGHT  Code: -M177;	3