

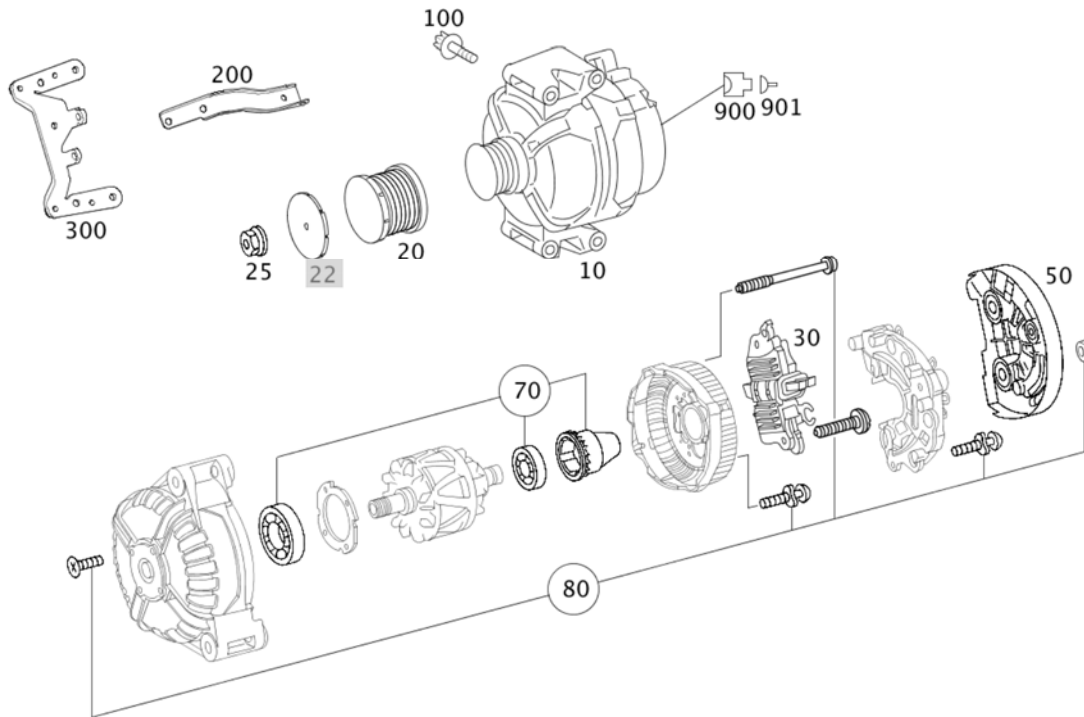























- Parts list -









Mode	BM mode	BM overview	S 400 HYBRID
VIN/mod. des.	WDD2211951A314065	Catalog	63V
VIN	WDDNG9FB7AA314065	Group	54 ELECTRICAL EQUIPMENT AND INSTRUMENTS
Assortment class	PC	Sub-group	026 ALTERNATOR



Copyright 2020-03-30 Daimler AG

Image ID: drawing_B5402600081

Item	Part number	Designation/additional information	Qty
10	A 014 154 28 02 	ALTERNATOR 14V/180A VALEO  Code: M272+ME04/M272+ME04+910;  Fault location 15101  Alternative parts are available	1
20	A 272 155 04 15 	* BELT PULLEY F POLY-V-BELT AT ALTERNATOR; VALEO  Code: M272+ME04/M272+ME04+910;	1
25	A 000 990 22 50 	* HEXAGON NUT WITH COLLAR BELT PULLEY TO GENERATOR; M16X1.5  Code: M272/M273;	1
30	A 003 154 87 06 	* REGULATOR SWITCH ALTERNATOR; VALEO Replaced by: A 004 154 08 06  Code: M272+ME04/M272+ME04+910;	1
30	A 004 154 08 06 	* REGULATOR SWITCH ALTERNATOR; VALEO Replaced by: A 004 154 19 06 Replaces: A0031548706  Code: M272+ME04/M272+ME04+910;  [414] THE OLD PART MUST NO LONGER BE INSTALLED	1
30	A 004 154 19 06 	* REGULATOR SWITCH ALTERNATOR; VALEO Replaces: A0041540806 Replaces: A0031548706  Code: M272+ME04/M272+ME04+910;	1
50	A 000 154 67 04 	* CAP AT ALTERNATOR; VALEO  Code: M272+ME04/M272+ME04+910;	1
70	A 000 980 57 15 	* TS DEEP-GROOVE BALL BRG. PARTS KIT WAREHOUSE; BOSCH  Code: (M272/M273)+-M005+-910;  Fault location 15127	1
80	A 000 990 62 99 	* TS ATTACHING PARTS PARTS COMPLETE BOLTS PARTS KIT; BOSCH  Code: (M272/M273)+-910+-M005;	1
100	N 910143 008011	HEXALOBULAR BOLT ALTERNATOR ON TIMING CASE; M8X90  Code: M272/(M273+-M002)/M276/M156;	4

Item	Part number	Designation/additional information	Qty
100	N 910143 008010	HEXALOBULAR BOLT M8X80  Code: M272+ME04;	4
200	A 272 154 04 45	BRACKET BRACKET TO ALTERNATOR  Code: M272+ME04;  Plant information	1
300	A 272 154 00 45	BRACKET ALTERNATOR ON TIMING CASE  Code: M272+ME04;	1
900	A 168 545 65 28	HOUSING ALTERNATOR G2; 2-PIN SLK2.8  Code: M272/M273/M642+-B03/M642+M014+-B03;	1
901	A 009 545 81 26	CONTACT SOCKET ALTERNATOR G2; 0.75-1.0 MM2 SLK2.8  Code: M272/M273/M642+-B03/M642+M014+-B03;	NB
901	A 000 545 78 80	SEAL BLIND PLUG, GREEN G2; 5.2 MM MLK1.2/SLK2.8/LKS1.5  Code: M272/M273/M642+-B03/M642+M014+-B03;	NB
901	A 000 545 71 80	GASKET ALTERNATOR G2; 1.1-2.1 MM SLK2.8  Code: M272/M273/M642+-B03/M642+M014+-B03;	NB