

Model 213.2

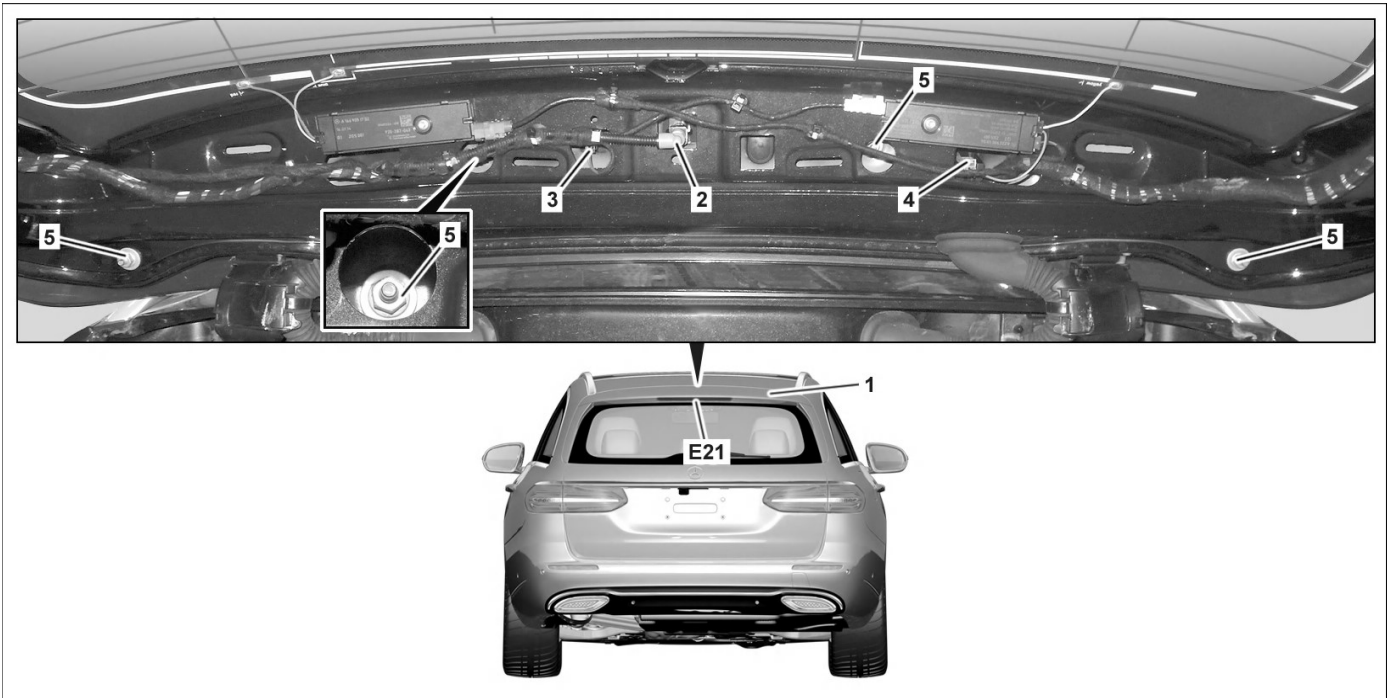

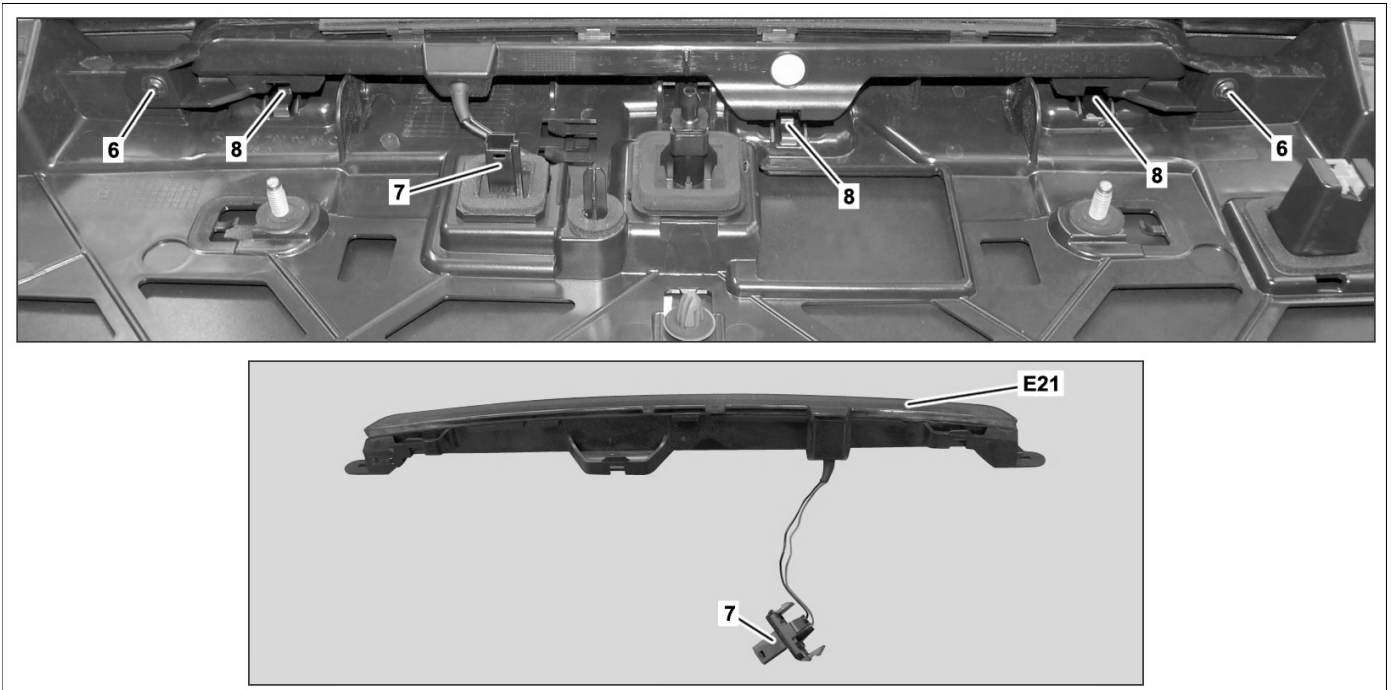





P82.10-8160-09

- 1 Roof spoiler
- 2 Water hose
- 3 Electrical connector
- 4 Electrical connector
- 5 Nut
- E21 Center stop lamp



P82.10-7674-09

- 6 Screw
- 8 Catch

 Danger !	Risk of injury caused by fingers being jammed or pinched when removing, installing or aligning hoods, doors, trunk lid/rear-end door or sliding roof.	No parts of the body or limbs should be within the operating area when the components are moving.	AS00.00-Z-0011-01A
	Information on preventing damage to electronic components due to electrostatic discharge		AH54.00-P-0001-01A
	Notes on sensor system for trunk lid opening/closing	Model 213.2 with code P17 (KEYLESS-GO package)	AH80.61-P-0001-01A
	Remove/install		
1	Remove upper liftgate paneling		AR72.20-P-6631LWS
2	Remove water hose (2) from spray nozzle	 Installation: Ensure correct seating of water hose (2) for rear window washer system.	
3	Disconnect electrical connector (3)		
4	Disconnect electrical connection (4)		
5	Unscrew nuts (5) and remove the roof spoiler (1)		
6	Remove bolts (6)		
7	Detach electrical plug (7) from the roof spoiler (1)		
8	Push catch (8) on the roof spoiler (1) downwards using a suitable tool		
9	Remove center brake lamp (E21) from the roof spoiler (1)	 Carefully remove center brake lamp (E21). Otherwise, damage can occur to the guides.	
10	Install in the reverse order		
	Check		
11	Perform function check of center brake lamp (E21)		