

Model 205.2  
 Model 213.2  
 Model 253  
 Model 293

Shown on model 205.2 except code 413 (Panoramic sliding sunroof)

- 1 Headliner
- 2 Sun visor
- 3 Bracket
- 4 A-pillar trim panel
- 5 Front grab handle
- 6 Rear grab handles
- 7 Upper B-pillar paneling
- 8 Covers
- 9 C-pillar paneling
- 10 D-pillar paneling
- 11 Edge guard
- A67 Inside rearview mirror

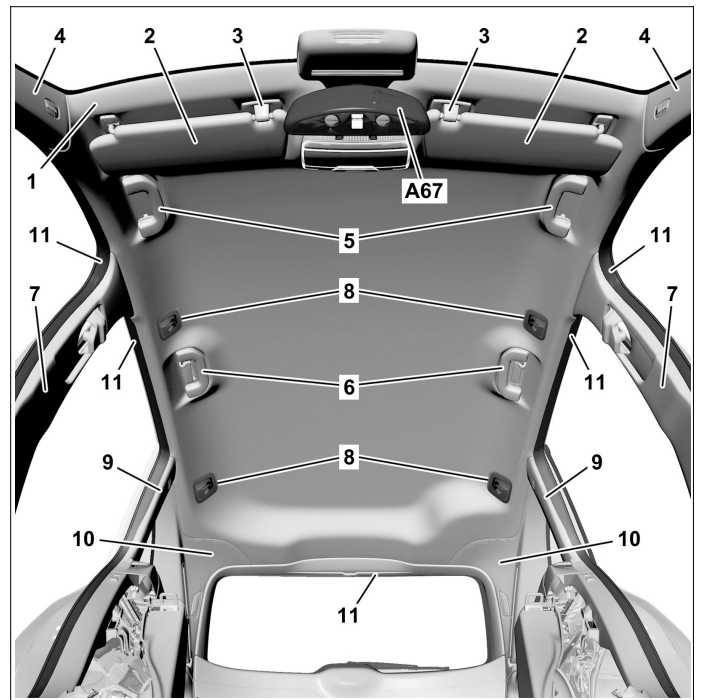

P68.30-3797-12

Shown on model 205.2 with code 235  
 (Active Parking Assist with PARKTRONIC)

- 12 Foam material
- 13 Electrical connector

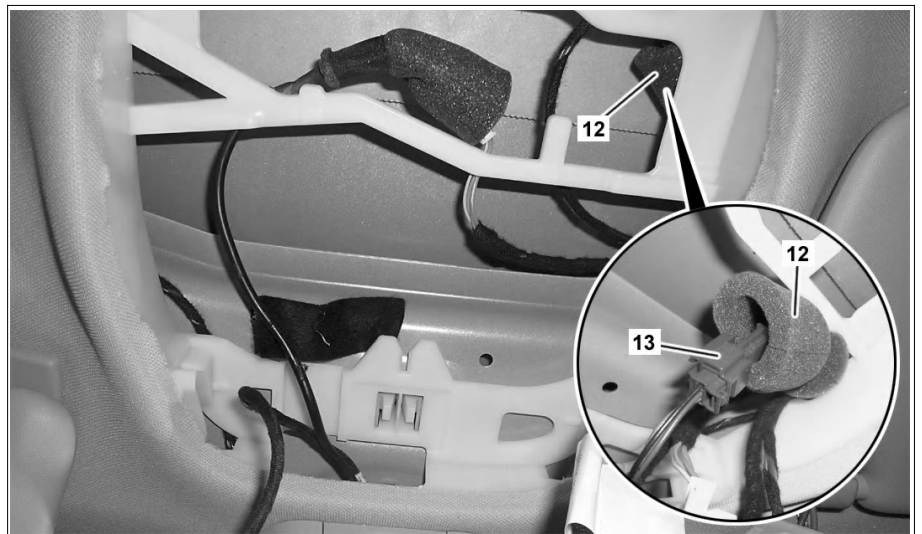

P68.20-4766-05

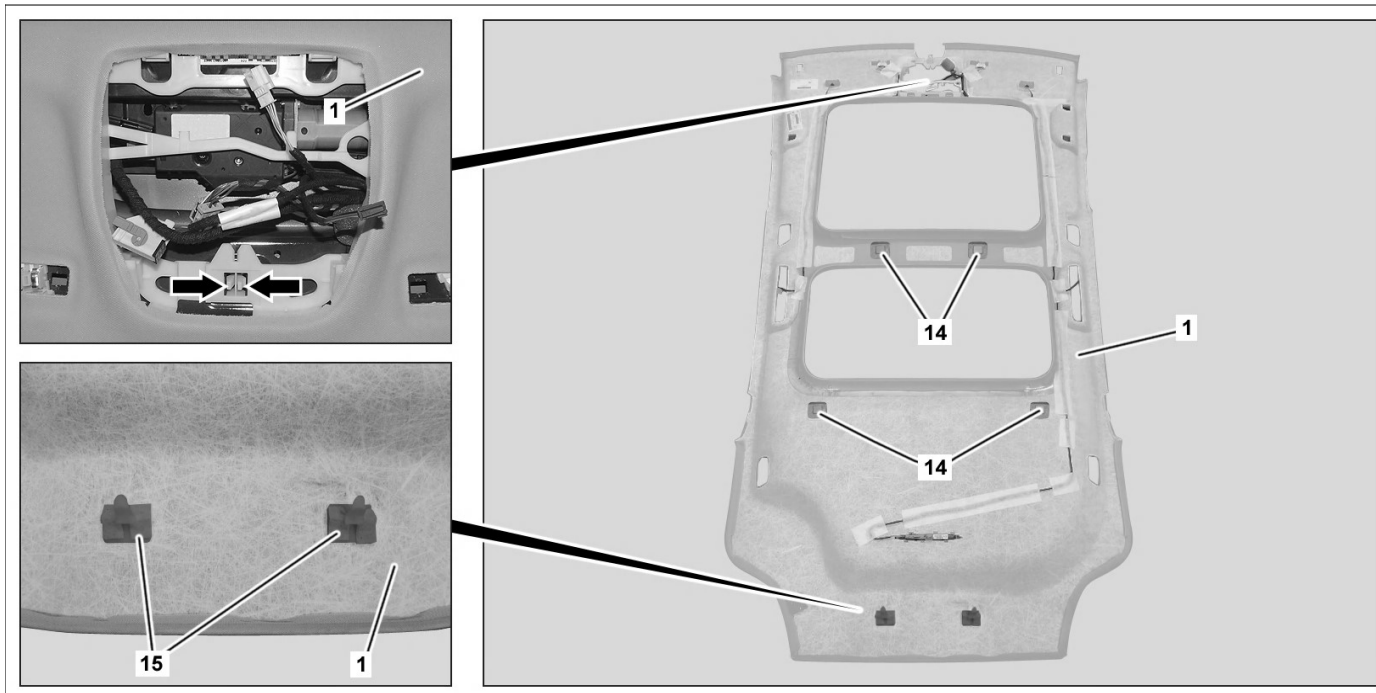











P68.30-3798-09



Shown on model 205.2 with code 235 (Active Parking Assist with PARKTRONIC) and with code 413 (Panorama sliding sunroof)

1 Headliner  
14 Solenoids

15 Guides

	Remove		
1	Completely open front roller sunblind and rear roller sunblind on panoramic roof.	Model 205.2, 213.2, 253 with code 413 (Automatic panoramic sliding sunroof)	
2	Remove inside rearview mirror (A67).		AR68.40-P-0001LW
3	Fold back foam material (12) and disconnect electrical connector (13).	Model 205.2, 213.2, 253 with code 235 (Active Parking Assist with PARKTRONIC)	
4	Remove sun visors (2) and brackets (3).		AR68.60-P-5480NKB
5	Remove left and right A-pillar trim (4).		AR68.30-P-4050LW
6	Remove front grab handles (5) and rear grab handles (6).		AR68.30-P-4330NKB
7	Release top left and right B-pillar trim (7) and remove from working area.		AR68.30-P-4700LW
		<b>i</b> Do not remove belt end fittings from front seats.	
8	Remove covers (8).	Model 205.2, 213.2, 253.1/9, 293 <b>S</b> Long wedge	*115589035900
9	Remove left and right C-pillar trim (9).	Model 205.2, 213.2 Model 253 (except 253.992/993), 293 Model 253.992/993	AR68.30-P-4490LWS AR68.30-P-4490LWG AR68.30-P-4490RFW
10	Remove left and right D-pillar trim (10).	Model 205.2 Model 253, 293 Model 213.2	AR68.30-P-4495LW AR68.30-P-4495LWG AR68.30-P-4497LWT
11	Detach edge guards (11) in the area of the roof lining (1) from the body flange.		
12	Adjust front seat head restraint downward.		
13	Adjust seat backrests of the front seats toward the rear.		
14	Fold back seat backrests in the rear passenger compartment.	Model 253.3	
15	Press catch hooks together (arrows) and lower front roof lining (1).		
16	Remove magnets (14) on roof lining (1) from roof.	<b>i</b> Model 253.3 There are two additional magnets (14) in the rear section of the headliner (1). <b>i</b> Velcro fasteners may be installed instead of magnets (14).	

		 Helper required for holding headliner (1).	
17.1	Push roof lining (1) toward the rear until the guides (15) on the rear roof frame are unhooked.	Model 205.2, 213.2, 253.1/9, 293	
17.2	Release roof lining (1) downward from roof frame.	Model 253.3	
18	Remove roof lining (1) from the vehicle toward the rear.	 Do not bend headliner (1) excessively. Otherwise the headliner (1) can kink and be damaged.  Helper required.	
19	Remove the old frames under the covers (8) from the brackets on the body.	Model 213.2	
	<b>Check</b>		
20	Check dampings on the roof lining (1) for correct seating and condition.	Model 213.2 with code 460 (Canada version) Model 213.2 with code 494 (US version) Model 253 with code 460 (Canada version) Model 253 with code 494 (US version) Model 293 with code 460 (Canada version) Model 293 with code 494 (US version) If the headliner (1) is reused. If there is a problem, ↓ Replace the affected soundproofing on the headliner (1).	
	<b>Install</b>		
21	Prepare new headliner (1) for installation.	When replacing roof paneling (1). Model 253.992/993 Model 205.2, 213.2, 253 (except 253.992/993), 293 Adhesive tape roll, non-woven Tesa tape, 50 meters, 50 mm wide	AR68.30-P-4305-16RFW <b>AR68.30-P-4305-16LW</b> <b>*BR00.45-Z-1144-02A</b>
22	Install new frame and new covers (8) on roof lining (1).	Model 213.2	<b>AR68.30-P-4300-13LWT</b>
23	Insert roof lining (1) into the vehicle from the rear.	 Do not bend headliner (1) excessively. Otherwise the headliner (1) can kink and be damaged.  Helper required.	
24.1	Fasten top roof lining (1) to roof frame.	Model 253.3  Ensure that guides (15) are correctly seated.	
24.2	Position roof lining (1) and push forward until the guides (15) are hooked on the rear roof frame.	Model 205.2, 213.2, 253.1/9, 293	
25	Fasten magnets (14) on roof lining (1) onto roof.	 Model 253.3 There are two additional magnets (14) in the rear section of the headliner (1).  Velcro fasteners may be installed instead of magnets (14).  Helper required for holding headliner (1).	
26	Engage frames under the covers (8) on the brackets on the body.	Model 213.2	
27	Engage roof lining (1) in the area of the catch hooks (arrows) on the roof frame.		
28	Fold back seat backrests in the rear passenger compartment.	Model 253.3	
29	Adjust seat backrests of front seats back into the default position.		
30	Adjust head restraints of the front seats back into the default position.		
31	Attach edge guards (11) in the area of the roof lining (1) to the body flange.		
32	Install left and right D-pillar trim (10).	Model 205.2 Model 253, 293 Model 213.2	AR68.30-P-4495LW AR68.30-P-4495LWG <b>AR68.30-P-4497LWT</b>
33	Install left and right C-pillar trim (9).	Model 205.2, 213.2 Model 253 (except 253.992/993), 293	<b>AR68.30-P-4490LWS</b> AR68.30-P-4490LWG

		Model 253.992/993	AR68.30-P-4490RFW
34	Install covers (8).	Model 205.2, 253.1/9 Model 293  Long wedge	*115589035900
35	Install left and right top B-pillar trim (7).	 Do not remove belt end fittings from front seats.	AR68.30-P-4700LW
36	Install front grab handles (5) and rear grab handles (6).		AR68.30-P-4330NKB
37	Install left and right A-pillar trim (4).		AR68.30-P-4050LW
38	Install sun visors (2) and brackets (3).		AR68.60-P-5480NKB
39	Connect electrical connector (13) and fold back foam material (12).	Model 205.2, 213.2, 253 with code 235 (Active Parking Assist with PARKTRONIC)  Completely pull foam material (12) over electrical connection (13). Otherwise noises can occur.	
40	Install inside rearview mirror (A67).		AR68.40-P-0001LW
41	Completely close rear roller sunblind and front roller sunblind on panoramic roof.	Model 205.2, 213.2, 253 with code 413 (Automatic panoramic sliding sunroof)	

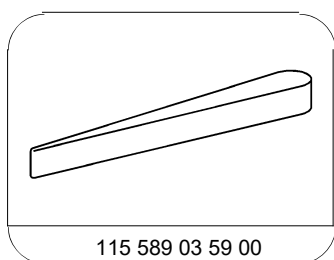

115 589 03 59 00

Long wedge

Repair materials

Number	Designation	Order number
BR00.45-Z-1144-02A	Adhesive tape roll, non-woven Tesa tape, 50 meters, 50 mm wide	A 008 989 50 85 09