

- Parts list -

Vehicle	WDDZF4JB3JA382846 (C213_FW)	E 300	
Color	040 - Black - standard finish	Equipment	124 - LEATHERETTE - BROWN
FIN: WDD2130481A382846		Assortment class	PC
Group	75 Trunk lid	Sub-group	030 Trunk lid push-button lock, trunk lid detachable parts

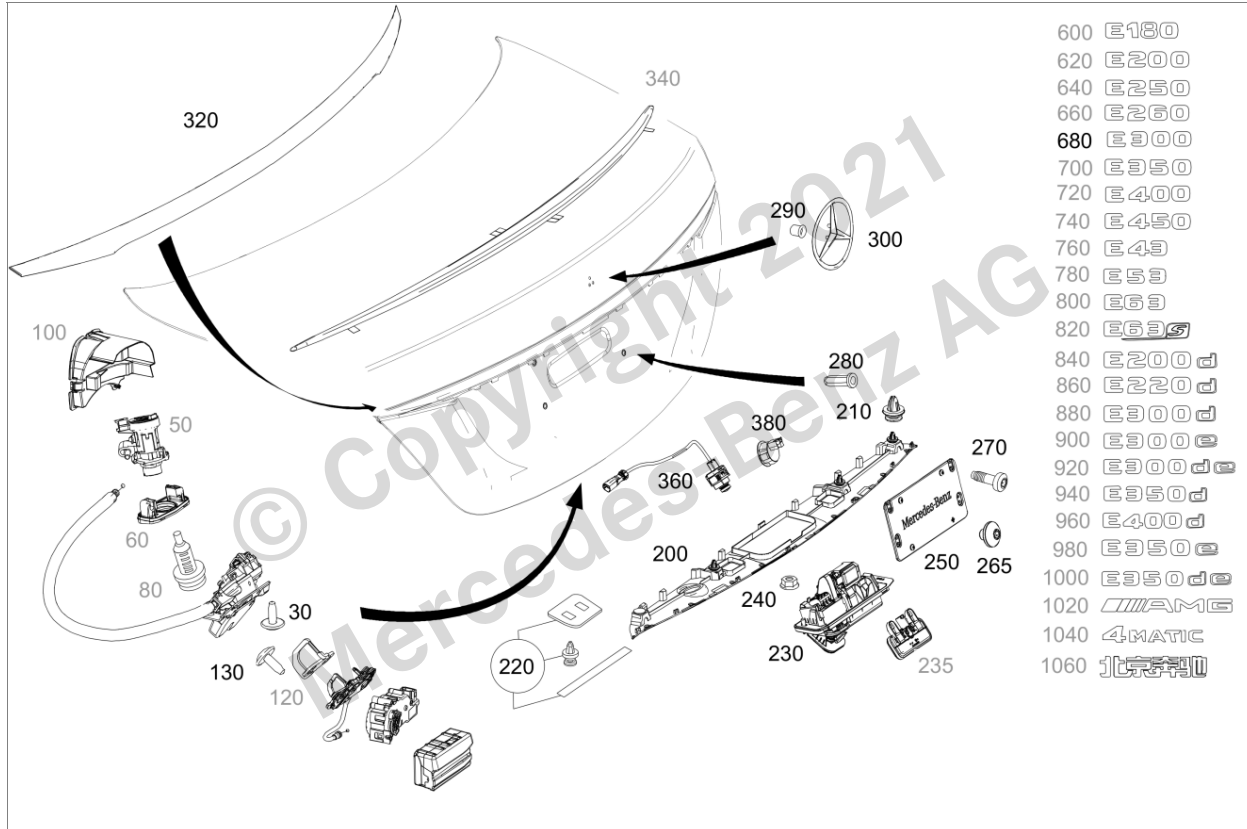





















Image ID: drawing_PV000.002.624.514_version_004

Item	Part number	Designation/additional information	Qty
10	A 117 750 00 85 	LOCK Code: -700; Replaced by: A 099 750 18 00	1
10	A 099 750 18 00 	LOCK Code: -700; Replaces: A 117 750 00 85	1
30	A 010 990 25 04	FILLISTER HEAD SCREW Lock to trunk lid; M6X17,2	2
130	A 010 990 25 04	FILLISTER HEAD SCREW Striker to rear-end center section; M6X17,2	2
140	A 212 750 00 84	LATCH POWER CLOSING SYSTEM Code: 881;	1
160	A 099 906 08 04	GEAR MOTOR Power closing Code: 881;	1

Parts Information

Item	Part number	Designation/additional information	Qty
180	A 213 750 19 00	DAMPING, DRIVE DRIVE  Code: 881;	1
200	A 213 750 31 00  	HANDLE STRIP Trunk lid  Code: FW+(807/808/809/800)+-700/FV+-700;	1
210	A 000 991 86 98 	* COVER CLIP Handle strip to trunk lid	3
220	A 204 743 00 93	MOUNTING MATERIAL Handle strip to trunk lid	1
230	A 099 750 08 00 	RELEASE HANDLE Trunk lid release  Code: (218/501)+(807/808/809/800); Replaced by: A 099 750 16 00 Replaced by: A 099 750 36 00	1
230	A 099 750 16 00 	RELEASE HANDLE Trunk lid release  Code: (218/501)+(807/808/809/800); Replaced by: A 099 750 36 00 Replaces: A 099 750 08 00	1
230	A 099 750 36 00	RELEASE HANDLE Trunk lid release  Code: (218/501)+(807/808/809/800); Replaces: A 099 750 16 00 Replaces: A 099 750 08 00	1
240	A 000 990 43 37	HEXAGON NUT HANDLE TO REAR LID; M6	2
250	A 000 810 17 11 	MOUNTING PLATE  Code: 264; Replaced by: A0008101711 28	1
265	A 009 990 84 04 	* FILLISTER HEAD SCREW NUMBER PLATE TO PLATE; M6X6  Code: 264;	4
270	N 000000 001181	HEXALOBULAR BOLT Plate to trunk lid; M5X16  Code: 263/264/829/879L;	4
280	A 210 990 11 58	RIVET NUT LICENSE-PLATE MOUNTING  Code: -700;	4
290	A 201 997 22 81	FASTENING GROMMET MERCEDES STAR TO REAR LID	3
300	A 213 817 01 16	MERCEDES STAR	1
320	A 213 757 00 00	TRIM STRIP Trunk lid  Code: (807/808/809/800)+-700;	1
360	A 000 905 62 06	CAMERA Rear view camera  Code: (807/808/809/800)+235+(218/501);	1
380	A 164 822 02 30	BUZZER TO TAILGATE  Code: 871;	1

Parts Information

Item	Part number	Designation/additional information	Qty
680	A 213 817 68 00	MODEL PLATE To trunk lid E300 ☒ Code: (M274+M20+M014)+-(M005/260);	1