

Model 213, 238

Modification notes

29.05.2017

Removal of Mercedes star added.

Operation step 2

Shown on model 213.045

- 1 Front bumper
- 2 Screw
- 3 Screw
- B14 Outside temperature sensor
- X26/38 Front bumper electrical connector

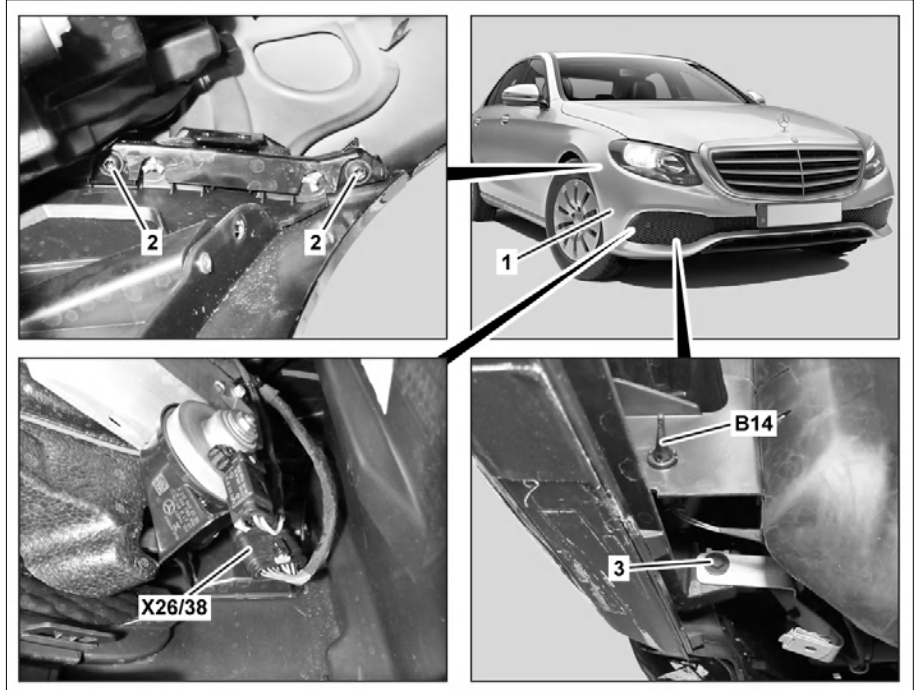

P88.20-4632-06

Shown on model 213.045

- 5 Catch hook
- 6 Screw

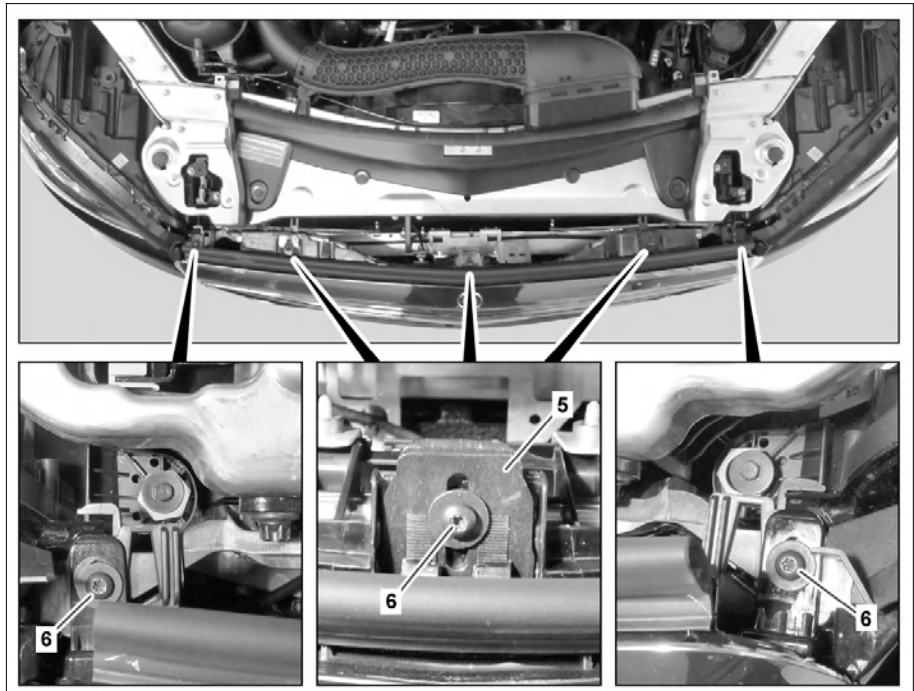

P88.20-4633-06

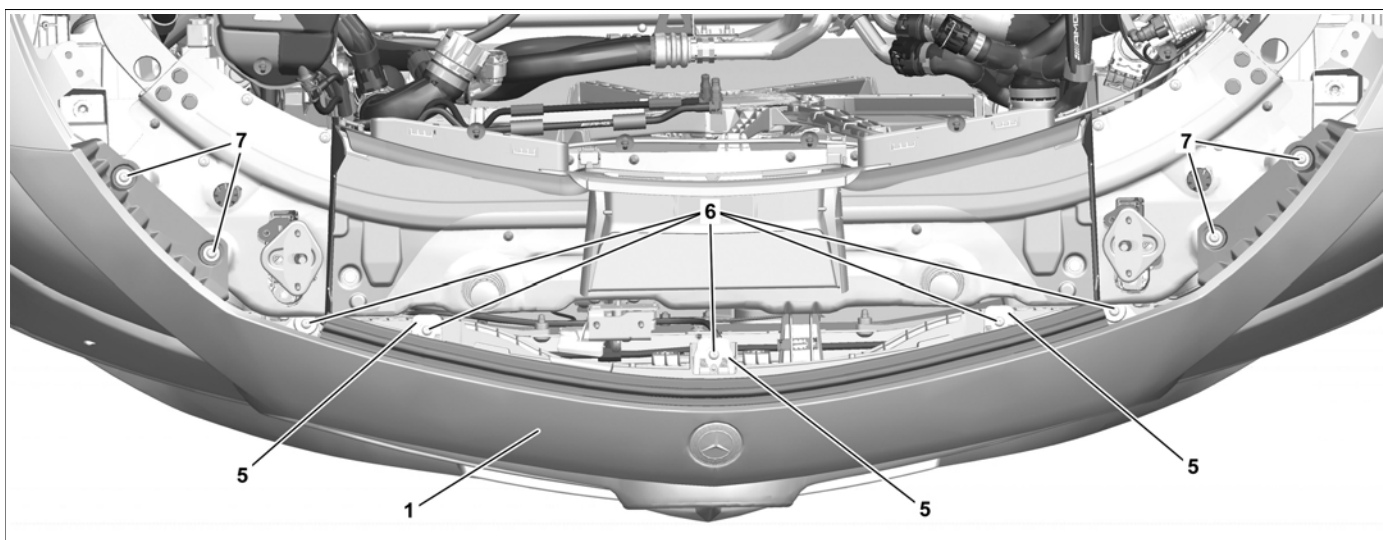







P88.20-4739-08

Shown on model 213.088

1 Front bumper
5 Catch hook

6 Bolts
7 Bolts

	Information on preventing damage to electronic components due to electrostatic discharge		AH54.00-P-0001-01A
	Remove/install		
1	Disconnect battery ground line	Model 213 Model 238	AR54.10-P-0003LW AR54.10-P-0003LWO
2	Remove Mercedes star	Model 213, 238 with code 233 (DISTRONIC PLUS) Model 213, 238 with code 239 (DISTRONIC PLUS)	AR88.40-P-4050LW
3	Remove wheel arch liner from front fenders	Model 213.2 with code M035 (Allroad version)	AR88.80-P-0005LWT
4	Remove front engine compartment paneling		AR61.20-P-1105LWE
5	Remove fender liner in left and right front fender from front bumper (1)		AR88.10-P-1300LWE
6	Remove bolts (2) on left and right of front bumper (1)		
7	Remove bolts (3) on left and right of front bumper (1)		
8	Disconnect front bumper electrical connector (X26/38)		
9	Remove outside temperature sensor (B14) from front bumper (1)		
10	Remove bolts (7)	Model 213.088/089/288/289  Installation: Tighten bolts (7) only after adjusting the gap dimensions.	
11	Remove bolts (6)	 Installation: Tighten bolts (6) only after adjusting the gap dimensions.	
12	Unlock catch hooks (5) and remove	 Installation: Press in catch hooks (5) only to first catch.	
13	Disconnect electrical connector from 360° camera at front	Model 213, 238 with code 501 (360° camera)	
14	Disconnect electrical connector from AIRPANEL	Model 213 with code 5U3 (AIRPANEL)	
15	Remove front bumper (1)	 Helper required.	
	Check		
	General information on the impact absorber		AH88.20-P-1000-01A
16.1	Check impact absorber for damage	Model 213, 238 except code U60 (Active Bonnet (Pedestrian protection)) If damage on impact absorber is visible. ↓	

		Replace impact absorber.	
16.2	Check the pedestrian protection sensor and impact absorber for damage of any kind (cracks, holes, breakovers, etc.) Notes on pedestrian protection sensor	Model 213, 238 with code U60 (Active Bonnet (Pedestrian protection)) If damage on impact absorber is visible. ↓ Replace the impact absorber and pedestrian protection sensor. If damage on the pedestrian protection sensor is visible. ↓ Replace the pedestrian protection sensor.	AH91.60-P-0001-01A AR91.60-P-0950LWE AR91.60-P-0950LWE
17	Install in the reverse order		
18	Adjust gap dimensions on front bumper (1)		AR88.20-P-2001LW
19	Calibrate front 360° camera using the diagnostic system	Model 213 with code 501 (360° camera) Model 238 with code 501 (360° camera)	AD00.00-P-2000-04B AD00.00-P-2000-06LWO