

- Parts list -

<b>Vehicle</b>	WDDZF6JB4KA516888 (C213_FW)	E 450 4MATIC Sedan	
<b>Color</b>	775 - Iridium silver - metallic finish	<b>Equipment</b>	121 - LEATHERETTE - BLACK / ANTHRACITE
FIN: WDD2130681A516888		<b>Assortment class</b>	PC
<b>Group</b>	42 Brake system	<b>Sub-group</b>	045 Rear wheel brake

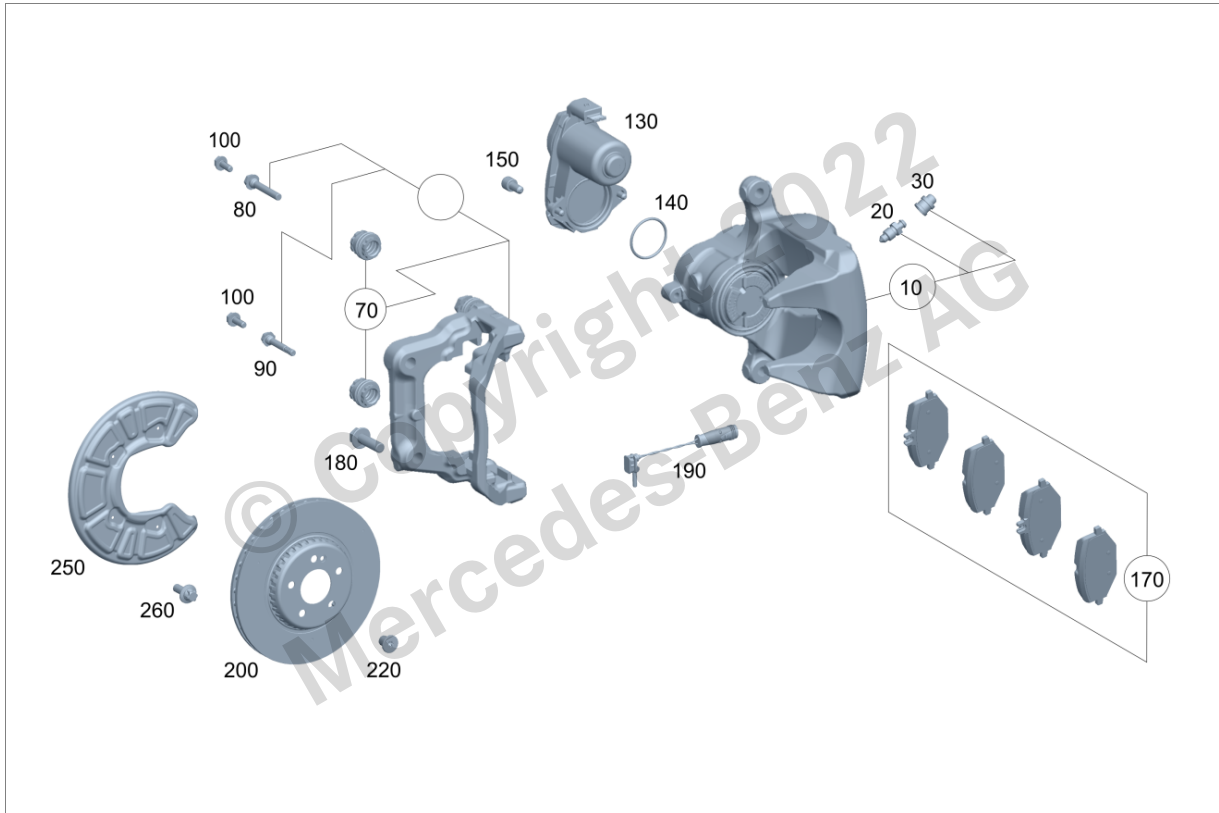





























Image ID: drawing\_PV000.002.623.500\_version\_004

Item	Part number	Designation/additional information	Qty
10	A 000 423 31 81	PISTON HOUSING Left parts kit Code: M276+(M30/M35)+M014+494; Replaced by: A 000 423 75 00	1
10	A 000 423 75 00	PISTON HOUSING Left parts kit [697] PART IS ONLY OR ALSO SUPPLIED AS RECONDITIONED PART Code: M276+(M30/M35)+M014+494; Replaces: A 000 423 31 81	1
10	A 000 423 32 81	PISTON HOUSING Right parts kit Code: M276+(M30/M35)+M014+494; Replaced by: A 000 423 76 00	1

Parts Information

Item	Part number	Designation/additional information	Qty
10	A 000 423 76 00 	PISTON HOUSING Right parts kit  [697] PART IS ONLY OR ALSO SUPPLIED AS RECONDITIONED PART  Code: M276+(M30/M35)+M014+494; Replaces: A 000 423 32 81	1
20	A 000 421 43 65 	* BLEED VALVE .  Code: M276+(M30/M35)+M014+494;	2
30	A 000 421 36 48 	* DUST CAP Bleeder Valve .  Code: M276+(M30/M35)+M014+494;	2
60	A 000 423 17 06 	BRAKE CARRIER Left caliper  Code: M276+(M30/M35)+M014+494;	1
60	A 000 423 18 06 	BRAKE CARRIER Right Caliper  Code: M276+(M30/M35)+M014+494;	1
70	A 001 421 43 86 	* PARTS KIT, BELLOWS Brake carrier at left and right  Code: M276+(M30/M35)+M014+494;	2
80	A 000 421 40 74 	* GUIDE SLEEVE Brake carrier at left and right  Code: M276+(M30/M35)+M014+494;	2
90	A 000 421 13 00 	* GUIDE PIN Brake carrier at left and right  [417] IS NO LONGER DELIVERED, ORDER DELIVERY CONTENTS  Code: M276+(M30/M35)+M014+494;	2
100	A 019 990 64 01	HEX. HEAD BOLT W. FLANGE Brake caliper to brake carrier on Left and Right; M8X22  Code: M276+(M30/M35)+M014+494;	4
130	A 000 906 10 04 	ACTUATOR Brake Caliper Left and Right  Code: M276+(M30/M35)+M014+494;	2
140	A 023 997 84 45 	* O-RING Actuator to brake caliper at left and right .  Code: M276+(M30/M35)+M014+494;	2
150	A 011 990 26 04 	* CAP BOLT W. HEXAL SOCKET Actuator to brake caliper at left and right .; M6X12  Code: M276+(M30/M35)+M014+494;	4
170	A 000 420 65 00	PARTS KIT, BRAKEPAD Parts kit  [431] WHEN SELLING BRAKE LININGS TO END USERS/DESK BUYERS THE A 203 005 25 99 IS TO BE HANDED OVER FREE OF CHARGE  Code: M276+(M30/M35)+M014+494; Replaced by: A 000 420 89 00 Replaced by: A 000 420 57 02 Replaced by: A 000 420 77 03	1

## Parts Information

Item	Part number	Designation/additional information	Qty
170	A 000 420 89 00	PARTS KIT, BRAKEPAD Parts kit 📄 [431] WHEN SELLING BRAKE LININGS TO END USERS/DESK BUYERS THE A 203 005 25 99 IS TO BE HANDED OVER FREE OF CHARGE 📄 Code: M276+(M30/M35)+M014+494; Replaced by: A 000 420 57 02 Replaced by: A 000 420 77 03 Replaces: A 000 420 65 00	1
170	A 000 420 57 02	PARTS KIT, BRAKEPAD Parts kit 📄 [431] WHEN SELLING BRAKE LININGS TO END USERS/DESK BUYERS THE A 203 005 25 99 IS TO BE HANDED OVER FREE OF CHARGE 📄 Code: M276+(M30/M35)+M014+494; Replaced by: A 000 420 77 03 Replaces: A 000 420 89 00 Replaces: A 000 420 65 00	1
180	N 910105 012010	HEXAGON HEAD BOLT BRAKE CALIPER TO WHEEL CARRIER LEFT; M12X1.5X40 📄 Code: -M177;	2
180	N 910105 012010	HEXAGON HEAD BOLT BRAKE CALIPER TO WHEEL CARRIER RIGHT; M12X1.5X40 📄 Code: -M177;	2
190	A 169 540 16 17	BRAKEPAD WEAR SENSOR BRAKE LINING WEAR INDICATOR	1
200	A 000 423 17 12	COMPOUND BRAKE DISK REAR LEFT 📄 [408, 552] ONLY REPLACEABLE BY PAIRS 📄 Code: M276+M30+M014;	1
200	A 000 423 17 12	COMPOUND BRAKE DISK Rear right 📄 [408, 552] ONLY REPLACEABLE BY PAIRS 📄 Code: M276+M30+M014;	1
220	A 220 421 01 71	FIT SCREW BRAKE DISK AT WHEEL HUB, LEFT; M8X12 📄 Code: -M177;	1
220	A 220 421 01 71	FIT SCREW BRAKE DISK AT WHEEL HUB, RIGHT; M8X12 📄 Code: -M177;	1
250	A 000 423 01 00	BRAKE COVER PLATE LEFT 📄 Code: -M177;	1
250	A 000 423 01 00	BRAKE COVER PLATE RIGHT 📄 Code: -M177;	1
260	N 000000 001114	HEXALOBULAR BOLT COVER PLATE TO WHEEL BEARING LEFT; M6X15 📄 Code: -M177;	3
260	N 000000 001114	HEXALOBULAR BOLT COVER PLATE TO WHEEL BEARING RIGHT; M6X15 📄 Code: -M177;	3