

- Parts list -

<b>Vehicle</b>	WDD2130041A723521 (C213_FW)	E 220 d Sedan	
<b>Color</b>	149 - Polar white	<b>Equipment</b>	314 - nut brown / black
<b>Assortment class</b>	PC	<b>Group</b>	69 Trim and lining
<b>Sub-group</b>	045 Trunk lining		

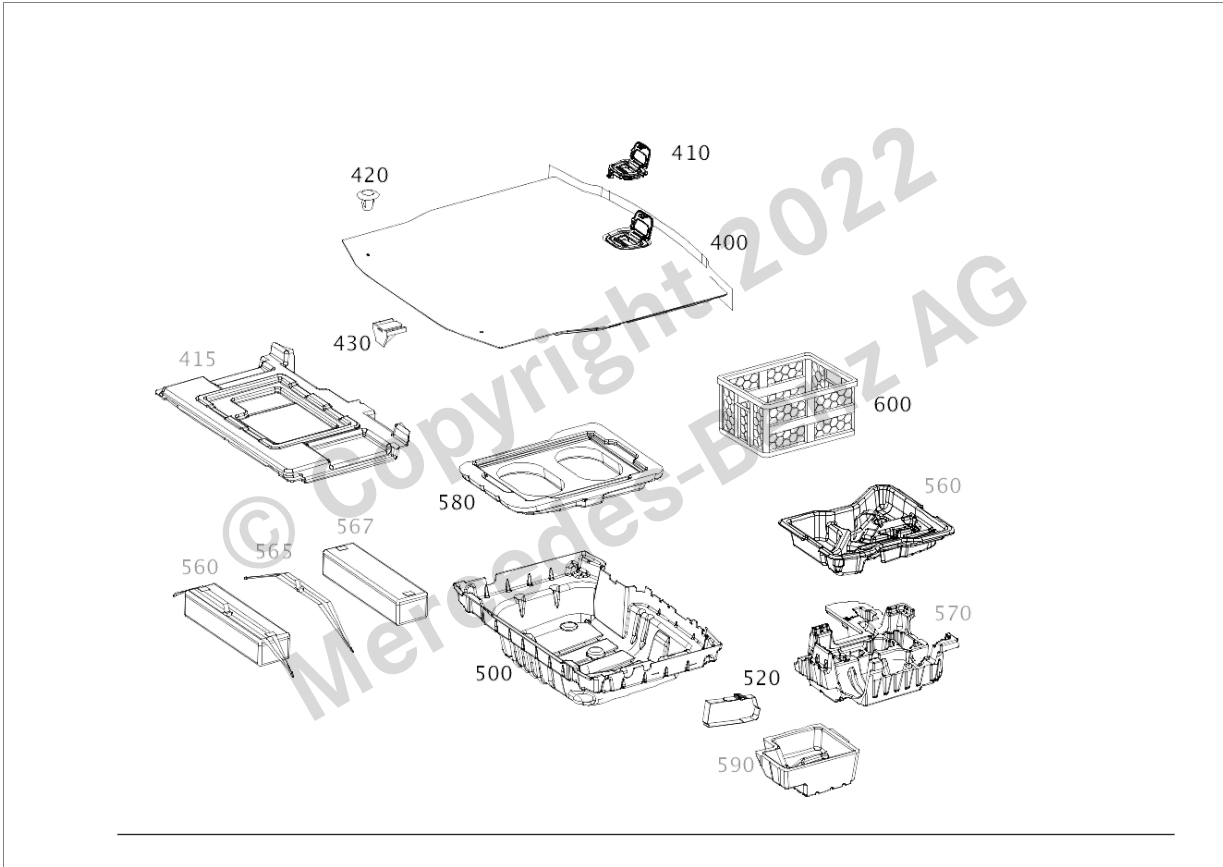

















































Image ID: drawing\_B69045000367

Item	Part number	Designation/additional information	Qty
10	A 213 690 52 05 9F08 	TRIM, LOAD COMPARTMENT LUGGAGE COMPARTMENT,LEFT  Code: -(ME06/ME05/811/ME08/700/807/808);	1
20	A 213 860 30 00 	* LUGGAGE NET Left trunk lining  Code: -(811/ME05/ME06);	1
60	A 000 991 47 95	PLUG-IN FASTENER TRUNK TRIM, LEFT  Code: -(811/ME05/ME06/700); Replaced by: A 000 991 71 00	5
60	A 000 991 71 00	PLUG-IN FASTENER TRUNK TRIM, LEFT  Code: -(811/ME05/ME06); Replaces: A 000 991 47 95	5

Parts Information

Item	Part number	Designation/additional information	Qty
90	A 213 684 34 00	BRACING TRUNK COVER ON LEFT, BOTTOM  Code: (FW+-(810/811/489/459/ME05)/FV+-(ME05/ME06/ME08/Z90/Z97/489/459/810/811/965));	1
100	A 213 690 33 06 	TRIM, LOAD COMPARTMENT Left	1
110	A 000 991 54 00  	* COVER CLIP TO PANELING FRONT, LEFT	3
120	A 000 991 55 00  	* FASTENING CLIP PANELING TO BODY AT LEFT	3
150	A 213 690 57 05 9F08 	TRIM, LOAD COMPARTMENT LUGGAGE COMPARTMENT,RIGHT  Code: -(ME05/ME06/ME08/700);	1
160	A 000 991 47 95	PLUG-IN FASTENER Right trunk lining Replaced by: A 000 991 71 00	4
160	A 000 991 71 00	PLUG-IN FASTENER Right trunk lining Replaces: A 000 991 47 95	4
170	A 213 692 00 01  	PROTECTIVE PADDING RIGHT TRUNK PANELING	1
180	A 000 991 71 00  	* PLUG-IN FASTENER	2
230	A 213 690 34 06 	TRIM, LOAD COMPARTMENT Right	1
240	A 000 991 54 00  	* COVER CLIP TO PANELING FRONT, RIGHT	3
250	A 000 991 55 00  	* FASTENING CLIP PANELING TO BODY AT RIGHT	3
260	A 213 690 51 05 9051  	TRIM, TRUNK SILL LOADING EDGE	1
265	A 011 988 76 78 	* COVER CLIP TRUNK SILL TO SHELL	4
270	A 000 991 71 00 	PLUG-IN FASTENER Trim to body	2
320	A 222 810 01 40	CLOTHES HOOK AT TOP REAR CENTER SECTION  Code: 30P;	1
340	A 213 693 16 00	COVER, REAR-END FLOOR TRUNK FLOOR FRONT  Code: -(ME05/ME06/ME08);	1
385	A 212 860 00 14	BRACKET LOAD SECURING DEVICE  Code: -(FW+(287/690/ME06/ME05/287+(ME06/ME05)))/(FV+(B12/ME08)));	2
390	A 212 868 00 74	LUGGAGE NET Trunk floor  Code: 30P+-(ME05/ME06/811); Replaced by: A 213 860 29 01 Replaced by: A 213 860 29 01	1

Parts Information

Item	Part number	Designation/additional information	Qty
390	A 213 860 29 01	LUGGAGE NET Trunk floor  Code: 30P+-(ME05/ME06/811); Replaced by: A 213 860 29 01 Replaces: A 212 868 00 74	1
400	A 213 680 78 07 9F08  	LINING, TRUNK FLOOR  Code: -(807/808);	1
410	A 099 693 02 00 	* LOCK LUGGAGE COMPARTMENT FLOOR  [414] THE OLD PART MUST NO LONGER BE INSTALLED  Code: FW+-924+-(ME05/ME06)/FV+-(700+ME05); Replaced by: A 099 693 03 00 Replaced by: A 099 693 03 00	1
410	A 099 693 03 00 9051  	* LOCK LUGGAGE COMPARTMENT FLOOR  Code: FW+-924+-(ME05/ME06)/FV+-(700+ME05); Replaced by: A 099 693 03 00 Replaces: A 099 693 02 00	1
420	A 000 991 43 95	PLUG-IN FASTENER MOUNTING, COVER, TRUNK FLOOR, FRONT  Code: -(ME05/ME06/ME08);	2
430	A 204 684 00 28	END STOP TRUNK LINING PATH DELIMITER  Code: -(924/ME05);	2
500	A 213 694 52 00 9F08 	LOAD CMPRT. WELL COVER  Code: B51+-(M177/ME05/ME06);	1
520	A 003 983 18 13	VELCRO STRIP 460 MM  Code: B51;	2
580	A 213 694 38 00	MOUNT  Code: 30P+-(ME05/ME06/M177);	1
600	A 203 840 00 20 9B51 	LUGGAGE BOX  Code: 30P+-(FS+(ME05/844/190))/(FW+190));	1