

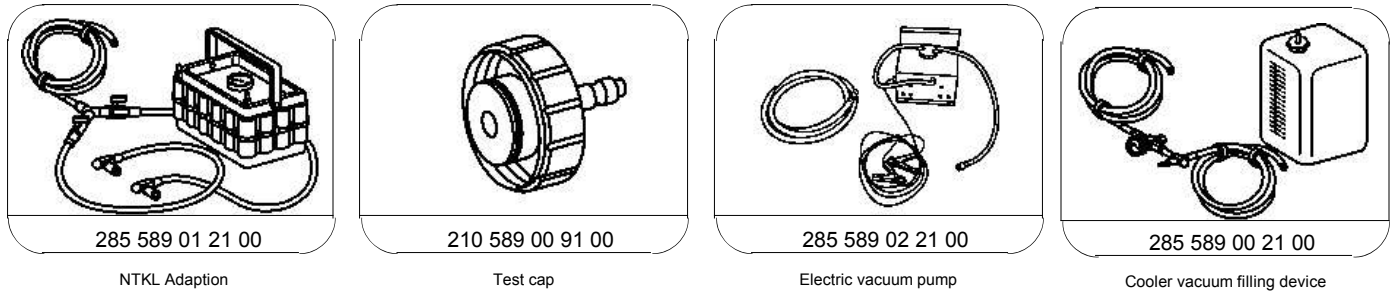

Engine 133, 152, 155, 156, 157, 159, 176, 177, 178, 260, 270, 271, 272, 273, 274, 275, 276, 277, 278, 279, 282
 Engine 157, 176, 177, 279, 642
 Engine 607, 608, 628, 629, 642, 651





i Engine 133, 157, 274, 276.8, 278, 279
 Engine 157, 176, 279
 Engine 176, 177, 178
 Engine 608 in model 177
 Engine 642 in model 164, 166, 204, 207, 211, 212, 213, 218, 222, 238,
 251, 253, 292
 Engine 651
 Also repeat the ventilation process for the low-temperature circuit.
i Only ventilate the engine cooling system for a cold engine.

i Empty drainage container for  NTKL adaptation (13) before beginning work.

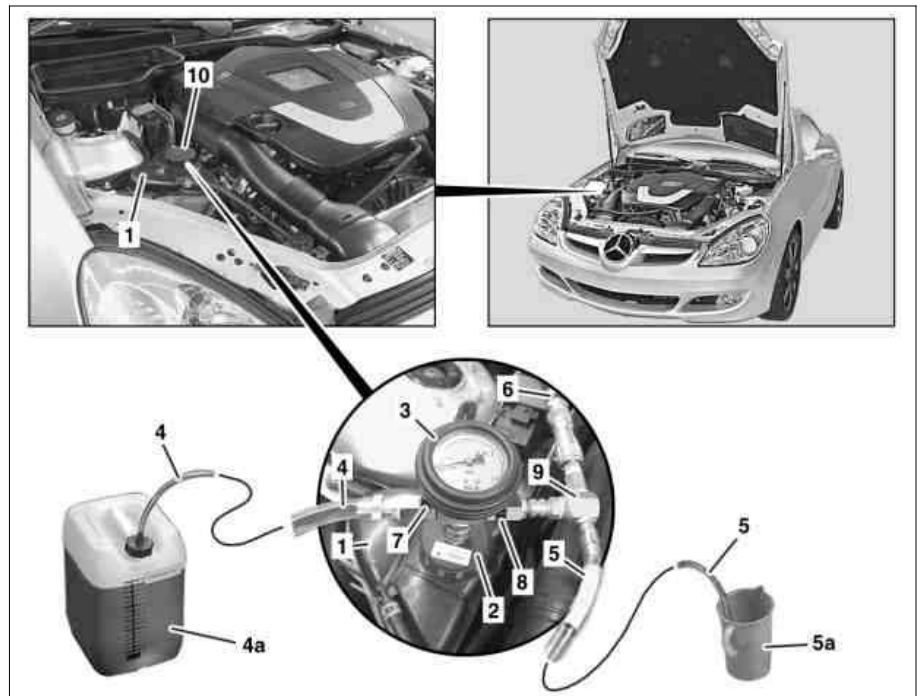
Shown on engine cooling system main circuit in model 171



P20.00-2250-06

- 1 Bring coolant reservoir(4a) of the  vacuum-type cooling system filler to the same height as the coolant expansion reservoir(1).
 - 2 Unscrew the cooling system closure cap (10) and screw on  tester cap (2) at coolant expansion reservoir (1).
 - 3 Attach the control unit (3) to the  tester cap (2) .
 - 8 Connect compressed-air hose(6) to Venturi nozzle(9) and apply pressure.
 - 9 Open the drain valve (8).
- i** The overpressure in the compressed-air supply system must be at least approximately 8 bar so that sufficient vacuum can be generated by the Venturi nozzle (9).

i A vacuum is created in the engine cooling system.

4 Attach Venturi nozzle(9) to control unit(3).

5 Close drain valve (8) and feed valve (7).

6 Place feed hose (4) of the coolant on the coolant reservoir (4).

i In order to avoid suctioning up of air in coolant reservoir (4a) and for completeness of the filling capacity of the engine cooling system in the vehicle, always completely fill up the coolant reservoir (4a).

7 Guide waste air hose (5) into an empty container (5a).

10 Open feed valve (7) until feed hose (4) has filled with coolant and then close feed valve (7) again.

11 Close drain valve (8) if display of the control unit (3) is in the green area.

12 Remove compressed-air hose(6) from Venturi nozzle (9) and monitor whether vacuum remains stable for 30 seconds.

If this is not the case.



Check hoses and connections for damage, repair if necessary and again create a vacuum.

13 Close feed valve (7) and drain valve (8).

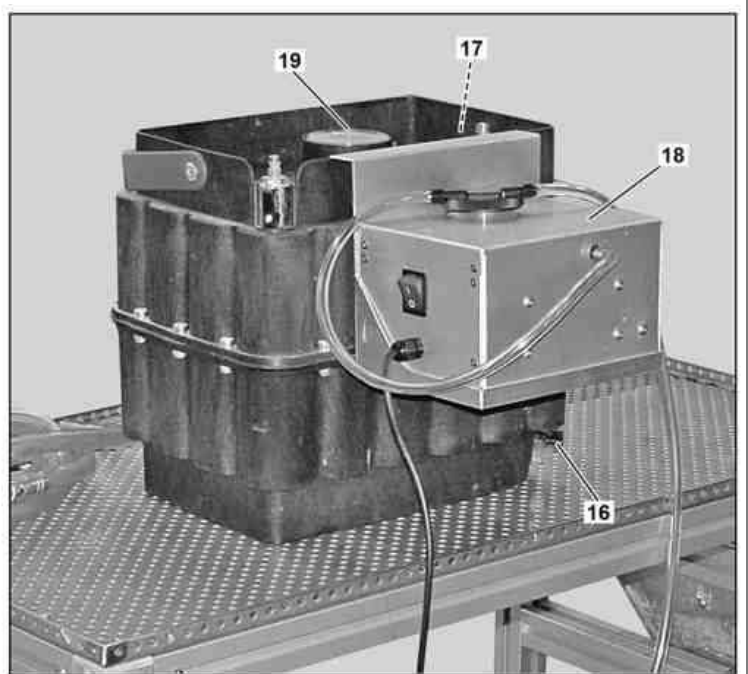
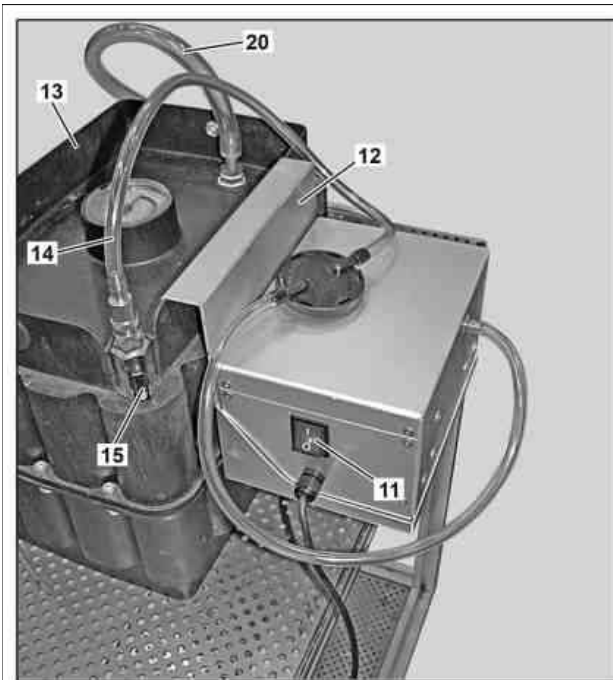

P20.00-2497-09

14 Move switch (11) of **i** electric vacuum pump (18) to 0 position.

i The vacuum indicator (19) must indicate at least -0.9 bar.

15 Connect positive and negative terminals of **i** electric vacuum pump (18) to a suitable 12 V voltage source.



22 Open the drain valve (8).

i Observe polarity of positive and negative terminals of **i** electric vacuum pump (18).

i The feed valve (7) must remain closed.



16 Hook bracket(12) into **i** NTKL adaptation(13).

i Evacuate entire engine cooling system for 5 min. The indicator for the vacuum indicator (19) must be above the -0.9 bar marking.

- 17 Connect hose (14) to  NTKL adaptation (13).
- 18 Close off shutoff valves (15, 16, 17).
- 19 Connect hose (20) to the  NTKL adaptation (13).
- 20 Decouple venturi nozzle (9) and replace by a hose (20).
- 21  Switch in electrical vacuum pump (18) and open shutoff valve (15).

Shown on engine cooling system main circuit in model 231

- 23 Close drain valve (8).
- 24  Switch off electrical vacuum pump (18).

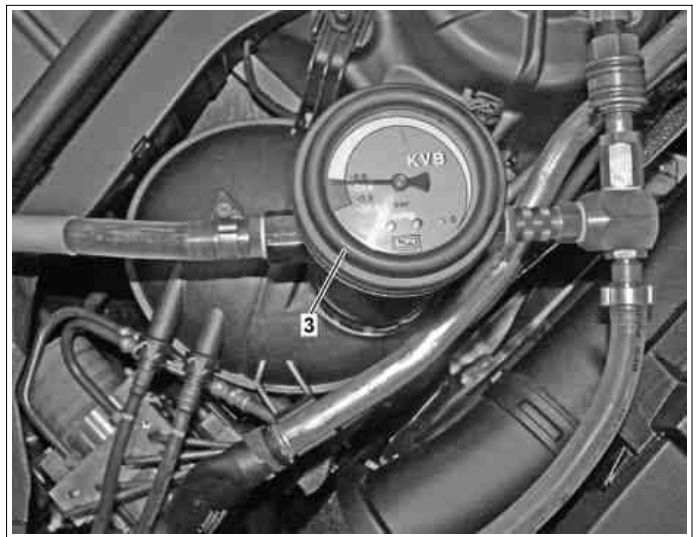

 Move switch (11) of  electric vacuum pump (18) to 0 position.
- 25 Take off hose (14) and reduce vacuum in  NTKL adaptation (13) until vacuum indicator (19) shows 0.0 bar.
- 26 Check entire engine cooling system for leak tightness by performing a visual check for 30 s.



P20.00-2498-11

- 27 Open feed valve (7).

 The engine cooling system is filled.

 0.0 bar.
- 28 Open drain valve (8) if coolant is no longer suctioned.
- 29 Remove control unit (3) along with all connections and  tester cap (2).
- 30 Correct coolant level in coolant expansion reservoir (1).
- 31 Screw cooling system cap (10) onto coolant expansion reservoir (1).