

Engine 276 in model 166, 292

Modification notes

26.06.2015

Motoröl

Motor 276.821/955

BF18.00-P-1001-01M

Engine 276.8

- 1 Oil filter screw-on cover
- 2 Oil filter element
- 3 Sealing ring
- 4 Oil dipstick
- 5 Oil-dipstick guide tube
- 6 Engine cover
- 8 Cold air duct

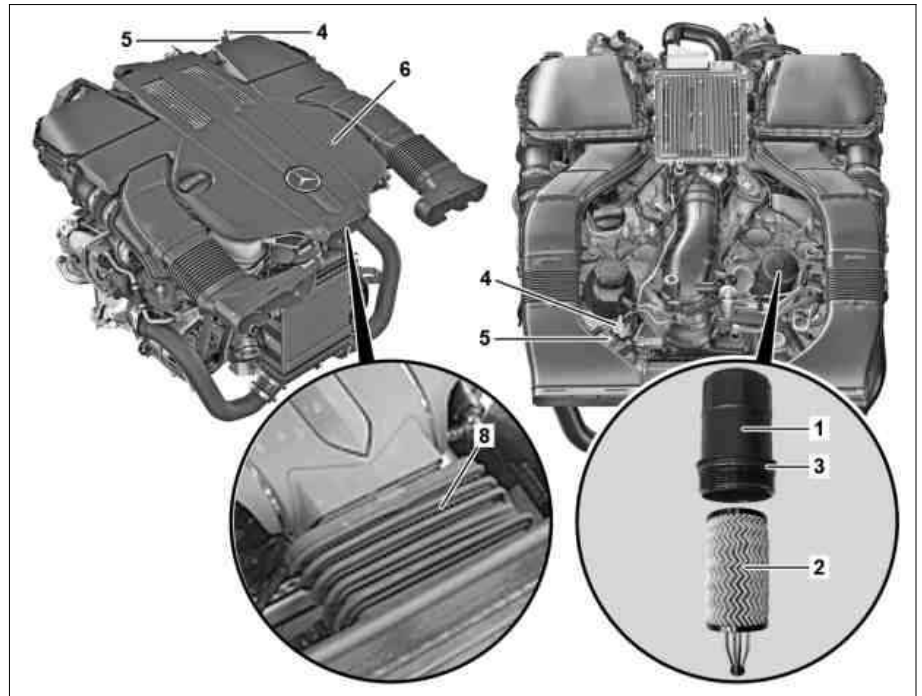

P18.00-2343-06

Engine 276.9

- 1 Oil filter screw-on cover
- 2 Oil filter element
- 3 Sealing ring
- 4 Oil dipstick
- 5 Oil-dipstick guide tube
- 6 Engine cover

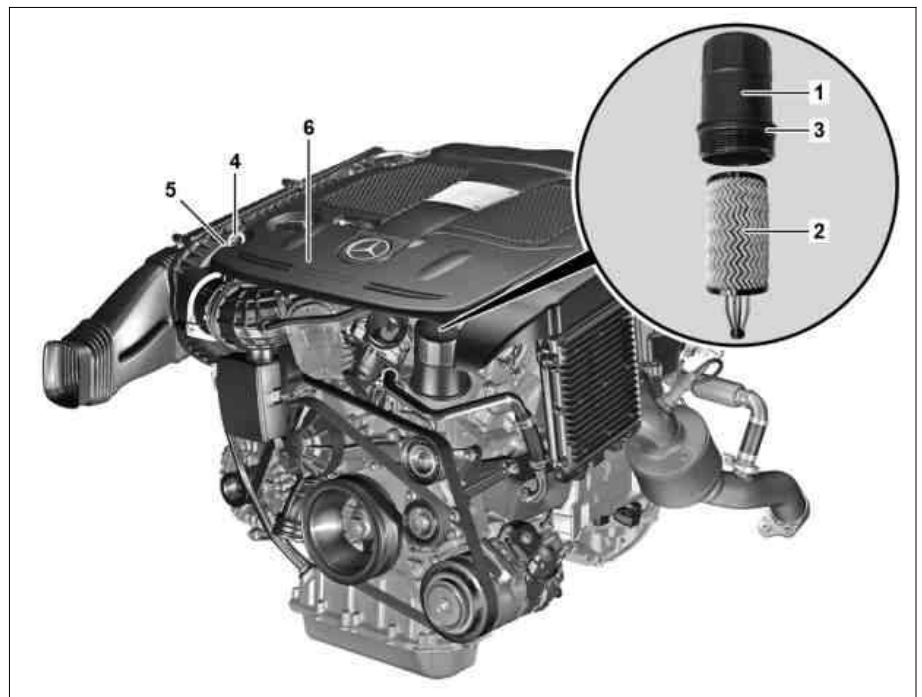















P18.00-2344-06

 Caution

Risk of injury to skin and eyes due to handling of engine oil. **Risk of poisoning** caused by swallowing engine oil

Wear protective gloves, protective clothing and safety glasses.
Do not fill engine oil into beverage containers.

AS18.00-Z-0001-01A

 Warning	Risk of accident from vehicle starting off by itself when engine running. Risk of injury (bruises and burns) resulting from working on the engine while it is being started or when it is running.	Secure vehicle to prevent it from starting off by itself. Wear closed and snug-fitting work clothes. Do not touch hot or rotating parts.	AS00.00-Z-0005-01A
	Notes on engine oil and filter changes		AH18.00-P-0104-01A
	Remove		
1	Allow engine to warm up	 Coolant temperature at least 80 °C.	
2	Pull oil dipstick (4) out of oil-dipstick guide tube (5) and wipe off using lint-free cloth	 The oil dipstick(4) and oil-dipstick guide tube(5) can be located at the front or rear of the engine, depending on the model series involved.	
3	Extract engine oil through oil-dipstick (5) guide tube		
4	Unclip cold air duct (8)	If installed	
5	Remove engine cover (6)		
6	Unscrew oil filter threaded cap_(1) using socket	 Wrench socket	*103589020900
7	Remove oil filter threaded cap (1)		
8	Replace oil filter element (2)		
9	Replace sealing ring (3)		
	Install		
10	Tighten oil filter threaded cap (1) using socket	 Mount, oil filter housing cover  Wrench socket	*BA18.20-P-1001-01Y *103589020900
11	Remove engine oil extractor		
12	Insert clean oil dipstick (4) into oil-dipstick guide tube (5)		
13	Add engine oil	 Use only approved engine oils. Engine damage can occur otherwise.  Engine oilEngine oil	*BF18.00-P-1001-01M
	Check		
14	Run engine until it is at operating temperature, and check for leaktightness	 Coolant temperature at least 80 °C. In the event of leakage: ↓ Determine and rectify cause, subject to separate repair order	
15	Switch off engine		
16	Check engine oil level using oil dipstick (4); correct if necessary	 Insert oil dipstick (4) into the oil-dipstick guide tube (5) until the end stop and hold in for a duration of at least 3 seconds.	AP18.00-P-1811MP
	Install		
17	Install engine cover (6)		
18	Clip in cold air duct (8)	If installed	

 Oil filter

Number	Designation	Engine 276
BA18.20-P-1001-01Y	Mount, oil filter housing cover	Nm 25

 Engine lubrication

Number	Designation	Engine 276.821/955
BF18.00-P-1001-01M	Engine oil	Oil filling capacity with Liter oil filter
		7,0
		Sheet
		Sheet
		Sheet
		BB00.40-P-0229-05 A
		Sheet
		Sheet

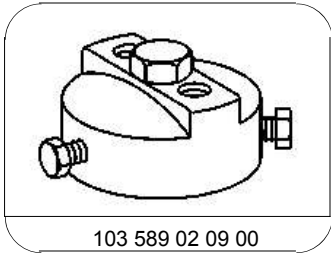

103 589 02 09 00

Wrench socket