

Model 166, 172, 292

Modification notes

13.04.2016

Operation steps added.

Operation steps 30, 31 and 33.

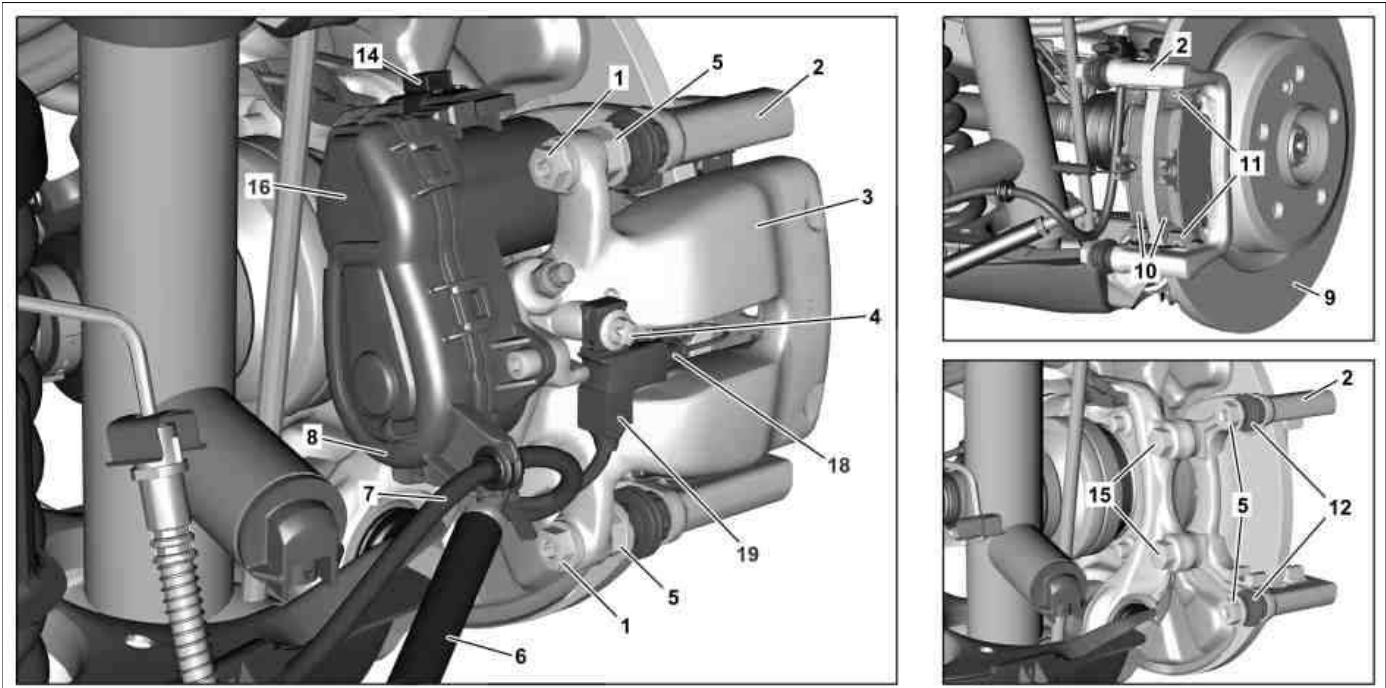

P42.10-3095-09

Shown on model 172.457







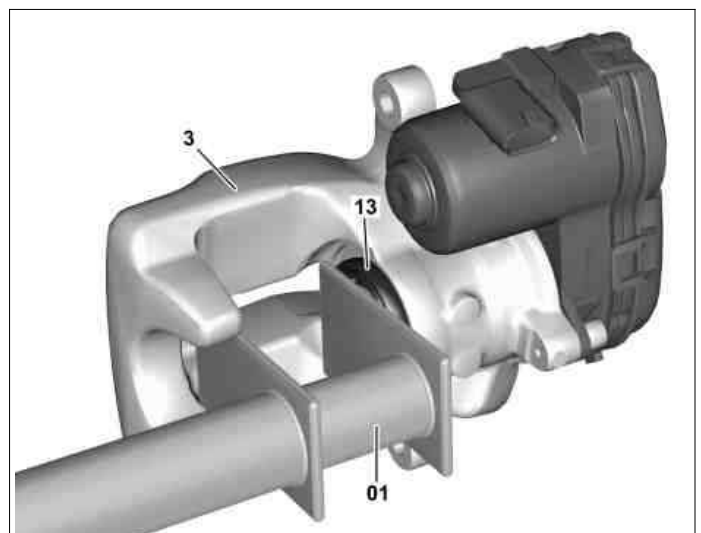









- | | | | | | |
|---|-----------------|----|---------------------|----|---------------------------------------|
| 1 | Screw | 7 | Electrical line | 14 | Electrical connector |
| 2 | Caliper support | 8 | Retaining frame | 15 | Bolts |
| 3 | Brake caliper | 9 | Brake disk | 16 | Electric parking brake actuator motor |
| 4 | Screw | 10 | Brake linings | 18 | Right rear brake wear sensor |
| 5 | Guide pin | 11 | Spring steel sheets | 19 | Electrical connector |
| 6 | Brake hose | 12 | Bellows | | |



Shown on model 172.457





- | | |
|----|---------------|
| 01 | Pusher tool |
| 3 | Brake caliper |
| 13 | Dust boot |



P42.10-2868-11

 Warning	Risk of injury. Skin or eye injuries may result when handling hot or glowing objects.	Wear protective gloves, protective clothing and safety glasses, if necessary.	AS00.00-Z-0002-01A
 Caution	Risk of poisoning from swallowing brake fluid. Risk of injury from skin and eye contact with brake fluid	Only pour brake fluid into suitable and appropriately marked containers. Wear protective clothing and eye protection when handling brake fluid.	AS42.50-Z-0001-01A
	Information on preventing damage to electronic components due to electrostatic discharge		AH54.00-P-0001-01A
	Notes on self-locking nuts and bolts		AH00.00-N-0001-01A
	Brake fluid notes		AH42.50-P-0001-01A
	Notes on repairs to brake system		AH42.00-P-0003-01A
	Notes on installing brake wear indicator contact sensors		AH42.10-P-0003-01CW
	Remove/install		
1	Move brake pads (10) of the rear axle into assembly position	 Do not depress the service brake during Move to assembly position . Otherwise, the spindle in the brake caliper (3) can be damaged.  Removal: The engine hood must be closed.  Installation: The assembly position for the brake lining (10) on the rear axle must be exited.	AR42.10-P-1700-02W
2	Switch off ignition and keep transmitter key at a location beyond transmitter range (at least 2 m)		
3	Remove cover over left suspension strut tower	Model 166, 292	
	Clean		
4	Clean the area around the cap of the brake fluid reservoir		
5	Unscrew cap of brake fluid reservoir and extract some brake fluid	 In order to prevent the brake fluid reservoir from overflowing when pressing back the brake pistons.  Extracted brake fluid must be disposed of properly.	
6  AP  AP	Detach rear complete wheels	Model 166 Model 172 Model 292	AP40.10-P-4050EW AP40.10-P-4050V AR40.10-P-1100GQC
7	Detach rear right brake wear sensor (18) from electrical connector (19)		
8	Unscrew bolt (4)	When removing brake caliper (3) on right side of vehicle.  Model 166, 292Screw/bolt, feed line for brake pad contact sensor to brake caliper  Model 172Screw/bolt, brake wear sensor to brake caliper	*BA42.10-P-1007-12L *BA42.10-P-1003-12J
9	Remove electrical connector (19)	When removing brake caliper (3) on right side of vehicle.	
10	Unclip electrical line (7) from retaining frame (8)	Model 172 When replacing brake caliper (3) on right side of vehicle.	
11	Disconnect electrical connector (14) from electric parking brake actuator motor (16)		
12	Remove bolts (1) from guide pin (5)	 Model 166, 292Screw/bolt, brake caliper to guide pin  Model 172Guide pin to brake caliper support or bolt for guide pin to brake caliper	*BA42.10-P-1004-12L *BA42.10-P-1004-12J
13	Detach brake hose (6) from brake caliper (3)	When replacing brake caliper (3). Model 166, 292 Model 172	AR42.10-P-0013GZ AR42.10-P-0013V
14	Seal the connections immediately using suitable stop plugs	When replacing brake caliper (3).  The brake caliper (3) must not run empty. Otherwise the brake caliper (3) must be replaced.  Record plug	*129589009100

15	Remove brake caliper (3) from brake caliper support (2)		
16	Attach brake caliper (3) to the vehicle free of tension to relieve the brake hose (6) and the electrical line (7)	When reusing the brake caliper (3). ⓘ Do not stretch or kink the brake hose (6). Otherwise, the brake hose (6) and the electrical line (7) can be damaged.	
17	Press back brake piston using pusher tool (01)	When reusing the brake caliper (3). ☑ Resetting device If brake piston is sluggish ↓ Replace brake caliper (3).	*000589524300
18	Detach electric parking brake actuator motor (16) from brake caliper (3)	When replacing brake caliper (3).	AR42.20-P-0600W
19	Remove brake pads (10) from brake caliper support (2)	When removing the brake caliper support (2). ⓘ Installation: Only sets of brake linings (10) approved by Mercedes-Benz may be installed. ⓘ Installation: Do not apply brake paste or lubricants to the brake linings (10) and brake calipers (3).	
20	Pull right rear brake wear sensor (18) out of brake lining (10)	When replacing the brakepads (10).	
21	Remove spring plates (11) from brake caliper support (2)	When replacing the brake caliper support (2).	
22	Remove screws/bolts (15)	When removing the brake caliper support (2). Nm Model 166, 292 Bolt, brake caliper support to wheel carrier Nm Model 172 Bolt, brake caliper/brake caliper support to wheel carrier	*BA42.10-P-1005-12L *BA42.10-P-1001-12J
	Measure		
23	Check brake linings (10) for wear and that they are in good condition AP AP AP	Model 172 Model 166 Model 292 If there are problems ↓ Replace set of brake linings (10).	AP42.10-P-4252SLB AP42.10-P-4252GB AP42.10-P-4252B AR42.10-P-1700W
24	Check brake disk (9) for wear and that it is in good condition AP AP	Model 166 Model 172 Model 292 If there are problems ↓ Replace sets of brake disks (9). Model 166, 292 Model 172 (except 172.466/475) Model 172.466/475	AP42.10-P-4258GQ AP42.10-P-4258V AR42.10-P-0120A AR42.10-P-0220GZ AR42.10-P-0220W AR42.10-P-0220MMI
	Check		
25	Check brake caliper (3) and dust boot (13) on brake piston for damage	If there are problems ↓ Replace corresponding component.	
26	Check boots (12) for damage and correct seat	If there are problems ↓ Replace boots (12).	
27	Check guide pin (5) for ease of movement	If there are problems ↓ Repair guide pin (5) and guide, replace, if necessary.	
	Clean		

28	Clean contact surfaces of brake linings (10) on brake caliper (3) and on brake caliper support (2)	 While doing so do not damage the dust boot (13) on the brake piston or the boots (12). Do not use sharp-edged or pointed objects. Otherwise the brake caliper (3) or the brake caliper support (2) must be replaced.	
29	Install in the reverse order		
	Initial startup		
30	Bleed brake system	When replacing brake caliper (3).	AR42.10-P-0010CW
 Danger	Risk of accident when commissioning the vehicle due to a lack of braking effect when the service brake is operated for the first time after repair work.	Before starting the engine, actuate brake pedal several times until pressure is built up and maintained in the brake system.	AS42.50-Z-0002-01A
31	Operate brake pedal several times until brake pads (3) make contact with brake disks (9)	 When operating the brake pedal, a firm resistance must be felt.	
	Check		
32	Check fluid level in brake fluid reservoir, and correct if necessary	Model 166, 292 Model 172	AP42.10-P-4210GZ AP42.10-P-4210V
33	Carry out brake test on the test stand		AP42.00-P-4290BA

 Rear axle brake caliper

Number	Designation	Model 172
BA42.10-P-1001-12J	Bolt, brake caliper/brake caliper support to wheel carrier Nm	110

 Rear axle brake caliper

Number	Designation	Model 172
BA42.10-P-1003-12J	Screw/bolt, brake wear sensor to brake caliper Nm	8

 Rear axle brake caliper

Number	Designation	Model 172
BA42.10-P-1004-12J	Guide pin to brake caliper support or bolt for guide pin to brake caliper Nm	28

 Rear axle brake caliper

Number	Designation	Model 166	Model 292
BA42.10-P-1004-12L	Screw/bolt, brake caliper to guide pin Nm	35	35

 Rear axle brake caliper

Number	Designation	Model 166	Model 292
BA42.10-P-1005-12L	Bolt, brake caliper support to wheel carrier Stage 1 Nm	60	60
	Stage 2 \angle°	45	45

 Rear axle brake caliper

Number	Designation	Model 166	Model 292
BA42.10-P-1007-12L	Screw/bolt, feed line for brake pad contact sensor to brake caliper Nm	8	8

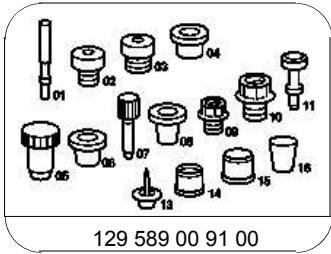

129 589 00 91 00

Record plug

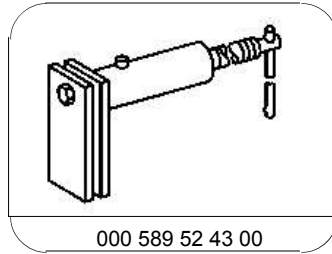

000 589 52 43 00

Resetting device