

Engine 256 in model 167, 213, 222, 238, 257 (except 257.358), 290

Modification notes

19.06.2018

Engine oil

BF18.00-P-1001-01MRT

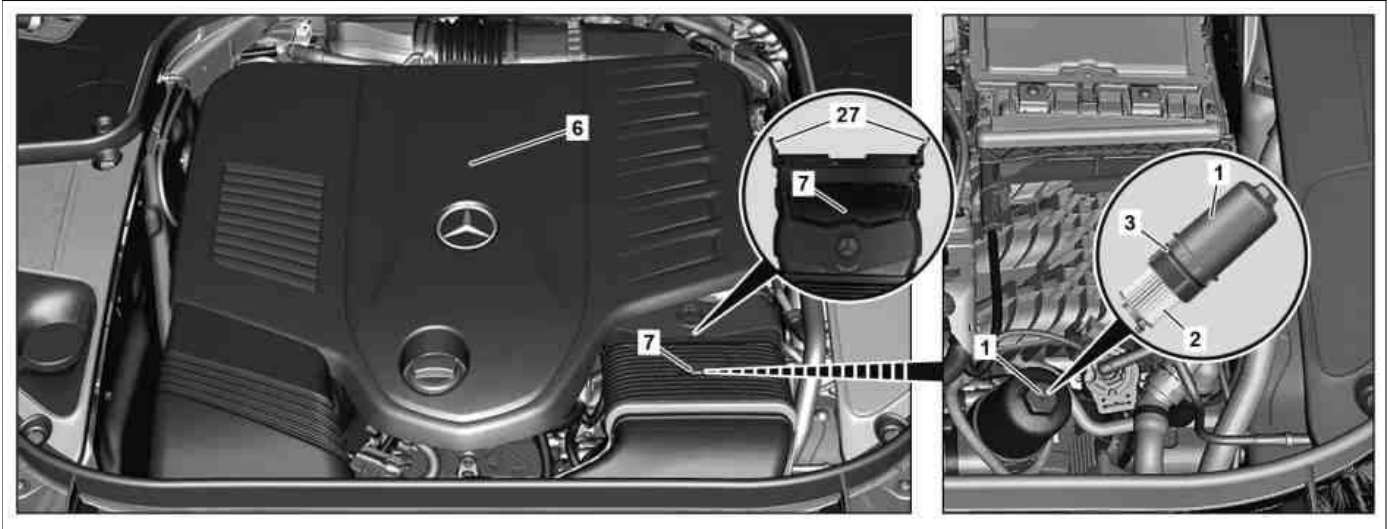

P18.00-2445-08

Shown on model 222.159

- 1 Oil filter cover
- 2 Oil filter element
- 3 Sealing ring







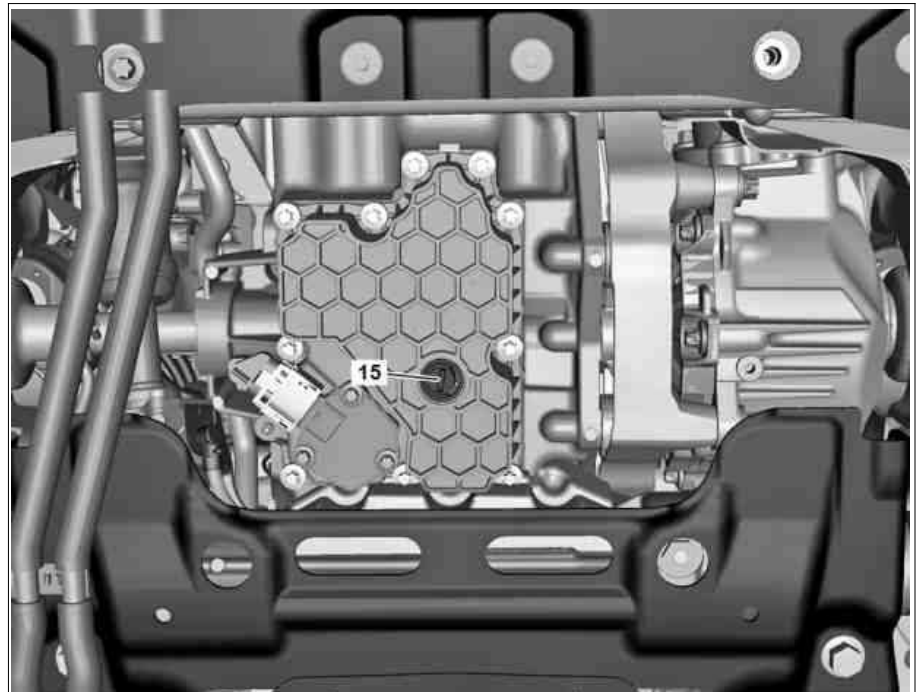







- 6 Engine cover
- 7 Air intake pipe
- 27 Locks

Shown on model 222.159

- 15 Drain screw



P18.00-2446-06

 Warning	Risk of accident from vehicle starting off by itself when engine running. Risk of injury (bruises and burns) resulting from working on the engine while it is being started or when it is running.	Secure vehicle to prevent it from starting off by itself. Wear closed and snug-fitting work clothes. Do not touch hot or rotating parts.	AS00.00-Z-0005-01A
	Risk of death caused by vehicle slipping or toppling off of the lifting platform.	Align vehicle between vehicle lift columns and position the four support plates at the vehicle lift support points specified by the vehicle manufacturer.	AS00.00-Z-0010-01A
 Caution	Risk of injury to skin and eyes due to handling of engine oil. Risk of poisoning caused by swallowing engine oil	Wear protective gloves, protective clothing and safety glasses. Do not fill engine oil into beverage containers.	AS18.00-Z-0001-01A
	Notes on engine oil and filter changes		AH18.00-P-0104-01A
	Remove		
1	Run engine to warm it up.	 Coolant temperature at least 80 °C.	
2	Switch off engine.		
3	Remove engine cover (6).	Model 167, 213, 222, 238, 257, 290 Model 222 Model 213, 238, 257, 290	AR01.10-P-2405MRT AR01.10-P-2405MSA
4	Loosen locks (27) and remove air intake pipe (7).		
5	Remove oil filter cover (1).	 Unscrew oil filter cover(1) far enough from oil filter housing so that the engine oil can drain out of the oil filter and oil filter housing.	
6	Remove center engine compartment lining.	Model 167, 213, 222, 238, 257, 290 Model 213, 238 Model 222 Model 257 Model 290	AR61.20-P-1105LWE AR61.20-P-1105LF AR61.20-P-1105FR AR61.20-P-1105FRX
7	Remove drain screw (15) at oil pan and drain engine oil.	 Dispose of old drain screw (15).	
	Install		
8	Screw in new drain screw (15).	 Drain screw to oil pan lower section	*BA01.45-P-1005-01MRT
9	Install center engine compartment lining.	Model 167, 213, 222, 238, 257, 290 Model 213, 238 Model 222 Model 257 Model 290	AR61.20-P-1105LWE AR61.20-P-1105LF AR61.20-P-1105FR AR61.20-P-1105FRX
10	Remove oil filter cover (1).		
11	Replace oil filter element (2).		
12	Replace sealing ring (3).		
13	Screw in oil filter cover (1).	 Oil filter cover	*BA18.20-P-1001-01MRT
14	Slide on air intake pipe (7) until the locks (27) latch into place.		
15	Add engine oil.	 Use only approved engine oils. Engine damage can occur otherwise.  Engine oil	*BF18.00-P-1001-01MRT
16	Install engine cover (6).	Model 167, 213, 222, 238, 257, 290 Model 222 Model 213, 238, 257, 290	AR01.10-P-2405MRT AR01.10-P-2405MSA
	Check		
17	Run engine until warm and check for leak tightness.	 Coolant temperature at least 80 °C. If leaks occur, ↓ determine cause and correct.  After obtaining special order.	
18	Check engine oil level with instrument cluster.	Model 213, 238, 290 Model 167, 222 Model 257	AP18.00-P-1812MKI AP18.00-P-1812SKI AP18.00-P-1812BKI

 Oil pan, oil level sensor

Number	Designation	Engine 256.9
BA01.45-P-1005-01MRT	Drain screw to oil pan lower section Plastic Nm	Tightened until engagement

 Oil filter

Number	Designation		Engine 256.9
BA18.20-P-1001-01MRT	Oil filter cover	Nm	25

 Engine lubrication

Number	Designation		Engine 256 in model 167, 213, 222, 238, 257 (except 257.358), 290
BF18.00-P-1001-01MRT	Engine oil	Oil filling capacity with Liter oil filter	8,5
		Overview sheet	BB00.40-P-0223-02 A
		References sheet	BB00.40-P-0226A