

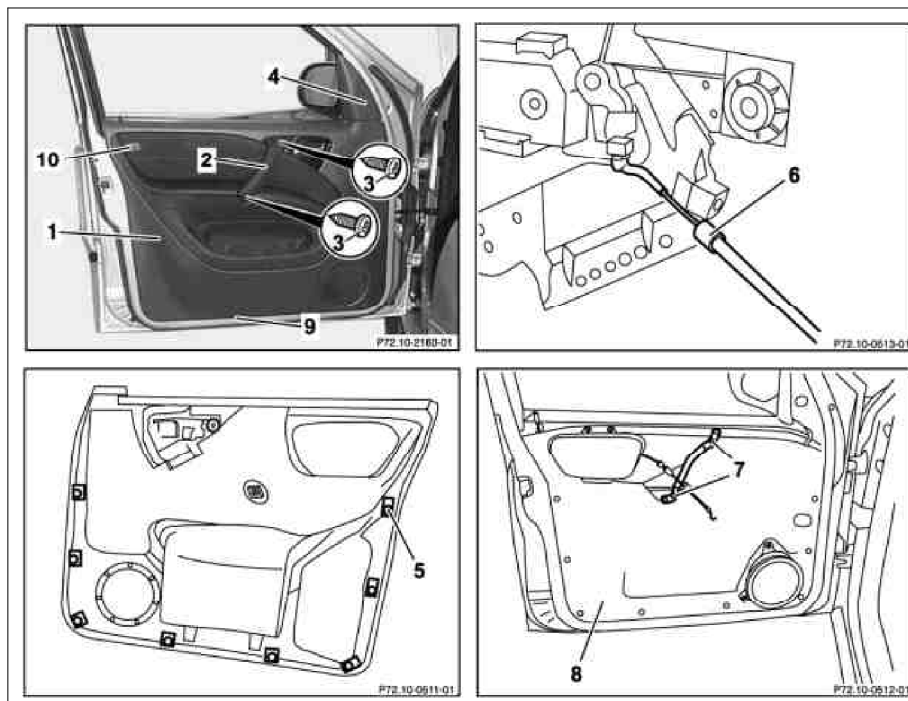











MODEL 163.113 /128 /136 /154 /157 /172 /174 /175

- 1 Door liner
- 2 Door handle cover
- 3 Bolt
- 4 Cover
- 5 Clips
- 6 Bowden cable
- 7 Sheet metal clip nuts
- 8 Door foil
- 9 Entrance lamp
- 10 Bolt



P72.10-2161-06

 	Remove/install		
1	Open crank window		
2	Remove cover for door handle (2)	 Press cover off using assembly wedge at bottom.  Assembly wedge	*110589035900
3	Unscrew bolts (3)		
4.1	Unclip SRS panel and unscrew screw (10)	 As of vehicle identification number A145273, X708319.	
5	Remove cover (4) with installation wedge	 Assembly wedge	*110589035900
6	Press door liner (1) off of inner door panel at bottom, front and rear with assembly wedge	 Position assembly wedge directly next to clips (5).  Assembly wedge	*110589035900
7	Lift door liner (1) up and out		
8	Unhook control cable (6) from inner door actuation		
9.1	Remove entrance lamp (9)	 As of vehicle identification number A145273, X708319.	
10	Lay down door liner		
11	Check sheet metal clip nuts (7) on inner door panel	 Replace damaged sheet metal clip nuts.	
12	Check door foil (8) on inner door panel and clips (5) on door	 Replace damaged door foil Replace all clips.	
13	Install in the reverse order		

