

AR46.30-P-0500B

Removing and installing power steering pump/Reservoir

19.9.96

MODEL 163

To R&I the reservoir, follow steps 2-4 only

Shown on Engine 112

30 Power steering pump

30a Reservoir

30b Sealing ring

30c Circlip

30f Return flow pipe

30h O-ring

30i High pressure expansion hose





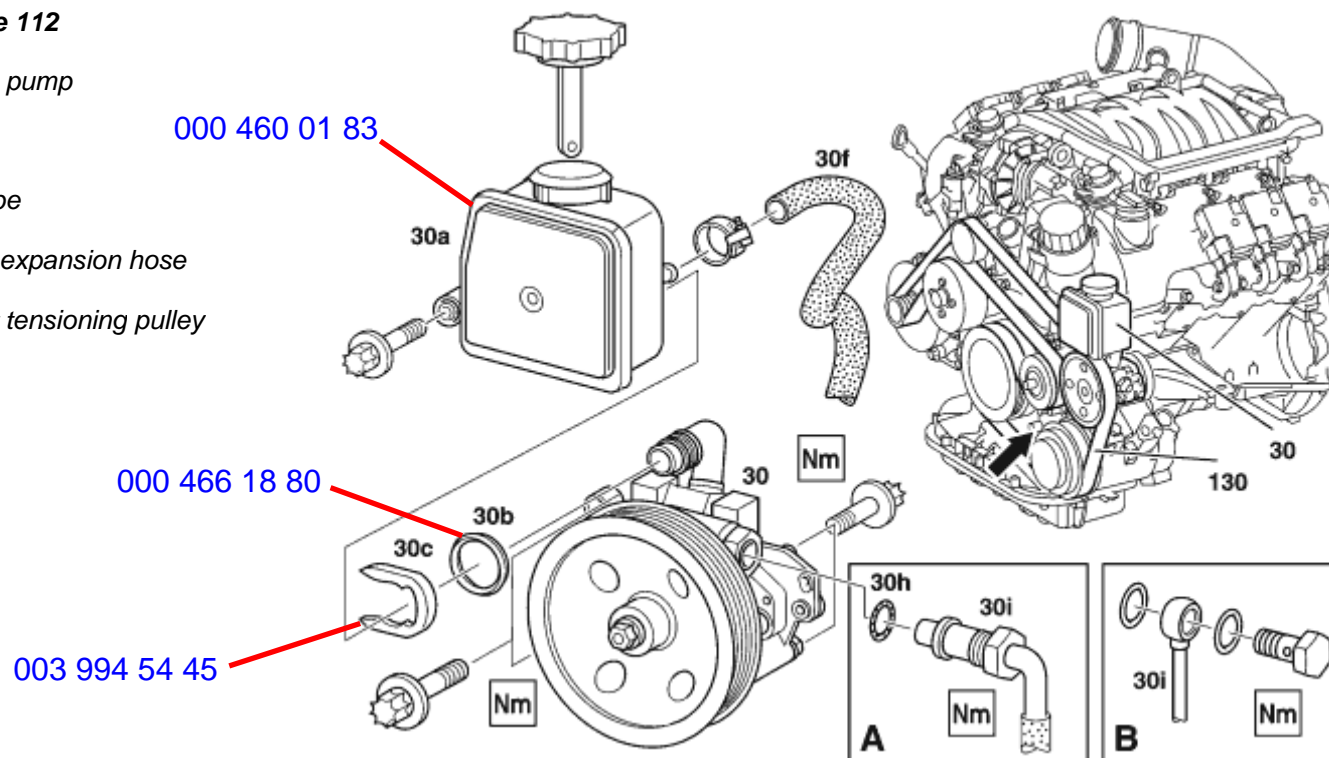









130 Poly-V-belt

Arrow: Poly-V-belt tensioning pulley



P46.30-2136-06

	Remove/Install		
1.1	Loosen poly-V-belt (130)	i Only Model163.	
2.1	Suction off oil from reservoir (30a)		
		S Hand pump	210 589 00 71 00

3	Detach return line (30f)	 Seal off line connection with blind plug.	
		 Model 163: ↓	
		 Return flow line at power steering pump	BA46.30-P-1002-01A
4.1	Remove reservoir (30a)	 Only Model163.  Removal: Use a suitable screwdriver to pry off circlip (30c).  Installation: Mount reservoir on power steering pump first, before the latter is installed.	
5	Unscrew high-pressure stretch hose (30i)	 Seal off line connection with blind plug.	
		 Installation: Check O-ring (30h) or sealing rings, replace if necessary.	
		 Model 163: ↓	
		 High-pressure expansion hose to power steering pump	BA46.30-P-1003-01A
6.1	Detach high pressure hose and suction line from power steering pump	 Vehicles with level control. Seal off intake line with clamp, and line connections with blind plugs.	
		 High-pressure hose, tandem pump	BA46.30-P-1004-01A
		 Clamping device	000 589 40 37 00
7	Detach power steering pump (30)	 Vehicles without level control: In addition detach the reservoir (30a) and together with the power steering pump (30) move forwards out of the guide rail.	

		<p>i Installation: If necessary replace self-tapping bolts, the following should be noted in the process:</p> <ul style="list-style-type: none"> ● Never recut thread , ● Only use original bolts, ● Do not fit bolts at an angle when screwing in ● Do not use an impact wrench. 	
		Front screws, power steering pump to timing case: Model 163: ↓	
		Nm Self-tapping bolt, power steering pump to timing case	BA46.30-P-1010-01A
		Rear screws: Model 163: ↓	
		Nm Screw, power steering pump to cylinder liner collar seat or crankcase	BA46.30-P-1005-01A
8	Install in the reverse order		
9	Fill power steering pump and bleed		AR46.30-P-0010B

Nm Power steering pump

Number	Designation			Model 163.154/157/172/174/175
BA46.30-P-1002-01A	Return line to power steering pump		Nm	2
BA46.30-P-1003-01A	High-pressure expansion hose to power steering pump	M14x1.5	Nm	-
		M16x1.5	Nm	45
BA46.30-P-1004-01A	High-pressure hose, tandem pump		Nm	25
BA46.30-P-1005-01A	Screw, power steering pump to cylinder liner collar seat or crankcase		Nm	25
BA46.30-P-1010-01A	Self-tapping bolt, power steering pump to timing case	Thread not pretapped	Nm	35

			Thread pretapped	Nm	20
--	--	--	------------------	----	----

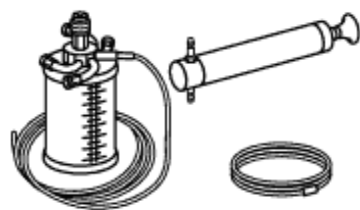

210 589 00 71 00

Hand pump

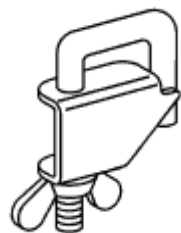

000 589 40 37 00

Clamping device