

AR54.30-P-6015GH	Remove instrument cluster	20.1.97
------------------	---------------------------	---------

MODEL 163

**Steering wheel removed for clarity**

- 3 Upper steering column cover
- 12 Side covering

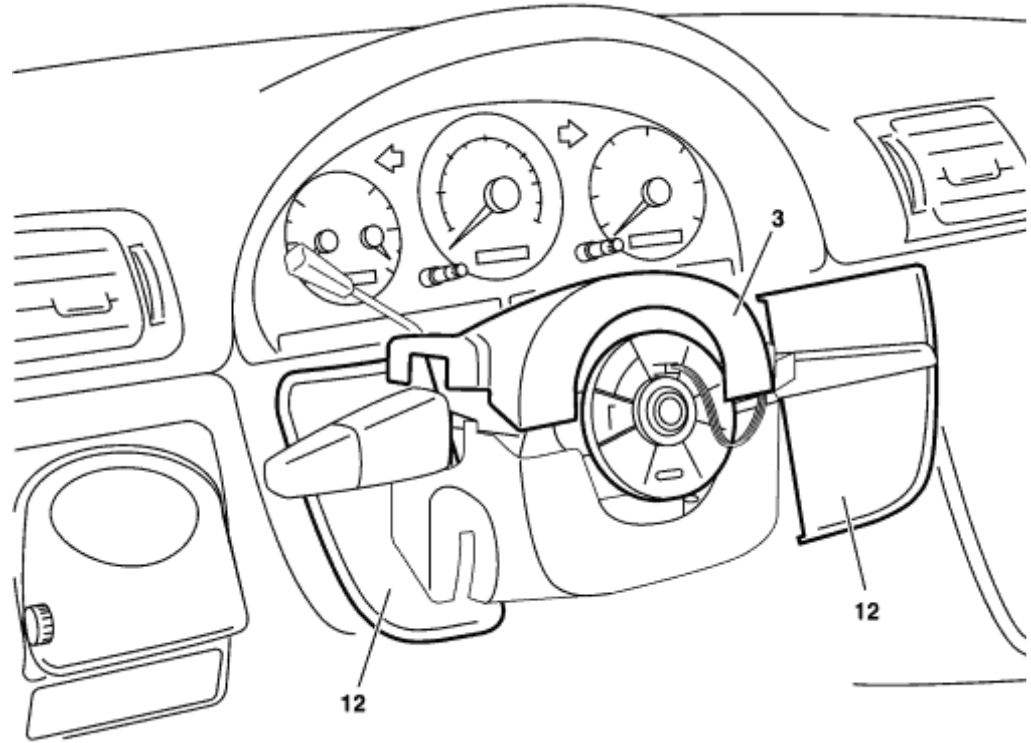

P54.25-2680-06

**Steering wheel removed for clarity**



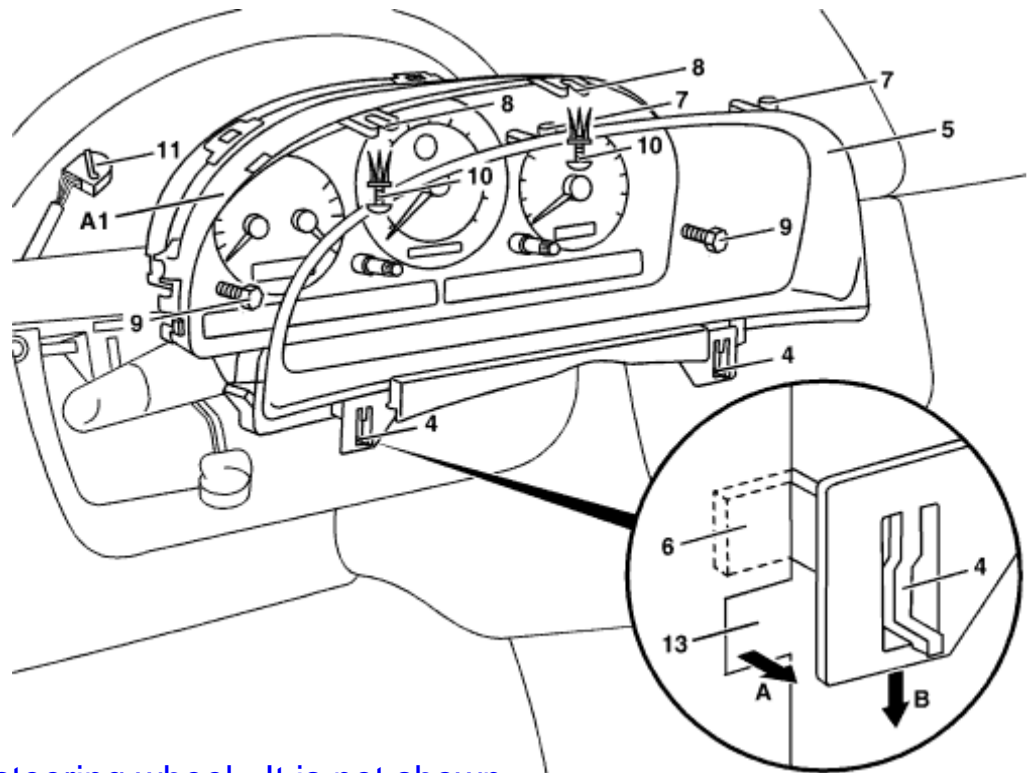







- 4 Clips
- 5 Frames
- 6 Hook
- 7 Lug
- 8 Mount
- 9 Screw
- 10 Spreading clips
- 11 Connector
- 13 Mount
- A1 Instrument cluster



P54.30-0630-06

There is no need to remove the steering wheel. It is not shown only for clarity purposes.

	Remove, Install		
1	<del>Disconnect ground cable of battery</del> Key out of ignition	To prevent unintended contact, insulate the ground lead cable lug.	<a href="#">AR54.10-P-0003A</a>
2	Unlock steering wheel and move to its lowest position	See Operating Instructions	
3	Remove upper steering column cover (3)	Risk of fracturing! Do not scratch the steering wheel.	
		Only as of VIN A145273, X708319:	

		Loosen clips on the side and front. Gently squeeze the cover together and pull out between the steering wheel and instrument panel.	
4	Remove side covers (12)	 Danger of breaking retaining lugs. Do not damage instrument panel.	
		 <b>Up to VIN A145272, X708318:</b> 3 covers: Remove side covers first. Detach center cover from instrument panel and rotate so that the retaining lugs point upwards. Then pull out to the right. <b>As of VIN A145273, X708319:</b> 2 covers: First remove the right cover, then the left. It is not necessary to detach the connectors. The covers can remain attached to the wiring harness.	
		 Long wedge	<a href="#">115 589 03 59 00</a>
5	Remove frame (5) of instrument cluster	 Lift clips carefully, risk of fracture.	
		 Push the clips (4) outwards (arrow direction A) and ease the frame down towards the footwell (arrow direction B) until the top of the frame disengages.	
		 <b>Installation:</b> Insert the hooks (6) of the frame into the bracket (13) and push the frame upwards until the clips snap into place.  <b>Installation:</b> Insert the lugs (7) on the frame into the receptacles (8) on the instrument cluster.	
6	Unscrew screws (9)		
7	Remove expanding clips (10)		
8	Pull instrument cluster (A1) forwards		
9	Unlock, open and pull off connector (11)		
10	Remove instrument cluster	 Make sure the steering wheel is not scratched.	
		 Tilt the upper edge of the instrument cluster towards the steering wheel and move to the right out of the instrument panel.	
11	Install in the reverse order		
12	Perform function check		
 AD	Instrument cluster (IC) diagnosis operational check		<a href="#">AD54.30-P-3000A</a>

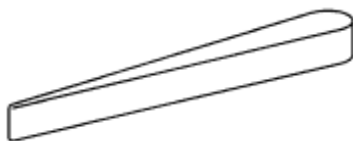

115 589 03 59 00

Assembly wedge