

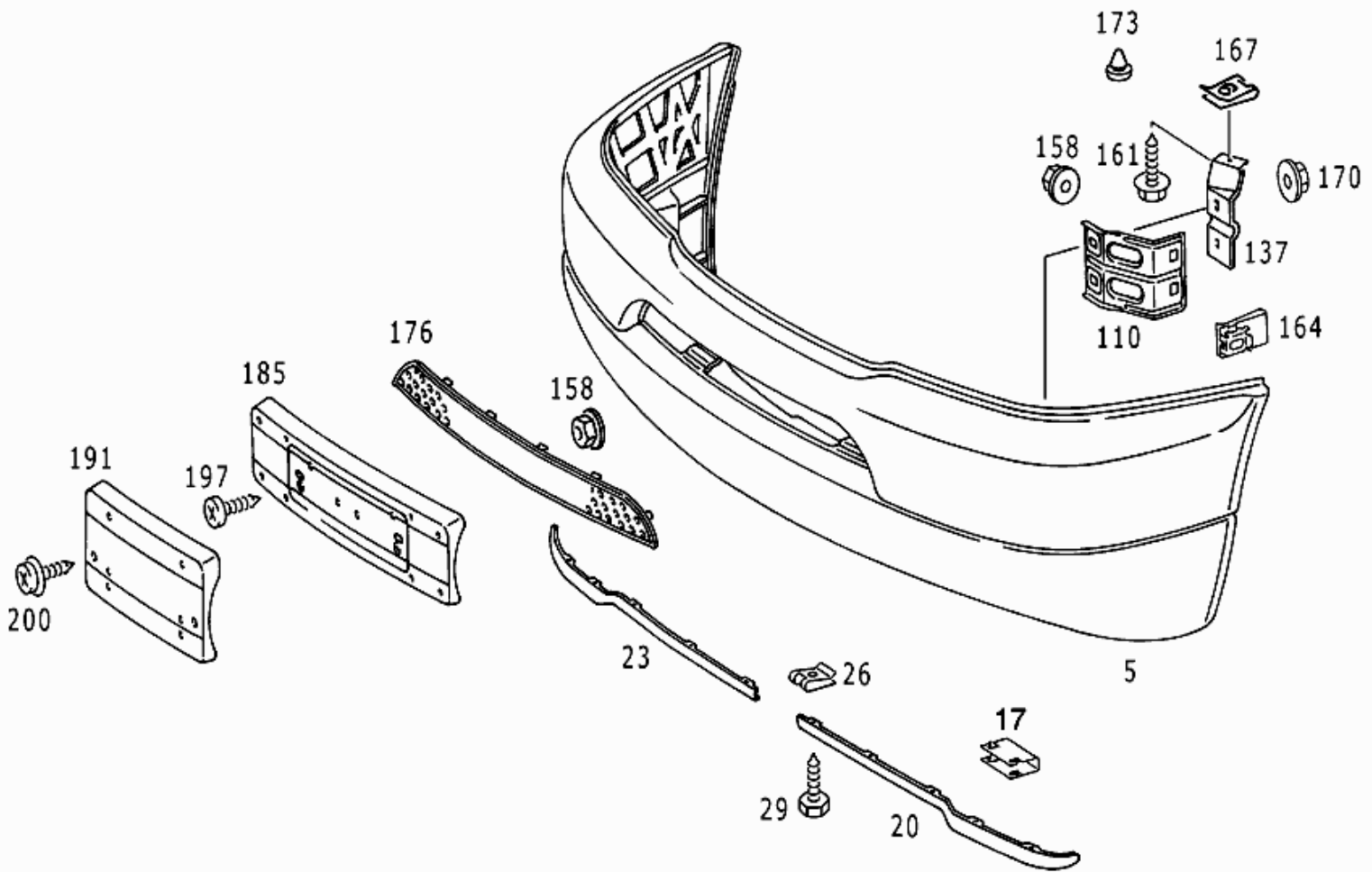













- Picture -

Mode	MD mode	Mod. des. overview	M-CLASS FROM IDENT NO. A221506 / X734088 WITH CODE 801
FIN/MD	4JG 1631541A262101	Catalog	06H -As of date 09/2000
VIN		Major assembly:	
Sales designation	ML 320	Major assembly MD	
Assortment class	Car	Group	88 - ATTACHMENT PARTS
Market	All	Subgroup	030 - FRONT BUMPER
Picture number	B88030000180.030226		



- Parts list -

Mode	MD mode	Mod. des. overview	M-CLASS FROM IDENT NO. A221506 / X734088 WITH CODE 801
FIN/MD	4JG 1631541A262101	Catalog	06H -As of date 09/2000
VIN		Major assembly:	
Sales designation	ML 320	Major assembly MD	
Assortment class	Car	Group	88 - ATTACHMENT PARTS
Market	All	Subgroup	030 - FRONT BUMPER

Item no.	Part number	Designation/description	Quantity	Version
5	A 163 880 38 70	FRONT BUMPER FACE BAR USED WITHOUT HEADLAMP CLEANING SYSTEM Code: -600  [811] Up to ident. no.:	001	
5	A 163 880 39 70	FRONT BUMPER FACE BAR USED WITHOUT HEADLAMP CLEANING SYSTEM Code: 841-600  [811] Up to ident. no.:	001	
17	A 008 988 75 78	CLIP  [811] Up to ident. no.:	002	
20	A 163 793 01 88	SPOILER LEFT Code: -(481/U49/841)  [922, 811] Color footnote	001	
23	A 163 793 02 88	SPOILER RIGHT Code: -(481/U49/841)  [922, 811] Color footnote	001	
110	A 163 885 01 14	BRACKET MOUNTING BUMPER  [811] Up to ident. no.:	002	
137	A 163 885 05 14	BRACKET FRONT LEFT  [811] Up to ident. no.:	001	
137	A 163 885 06 14	BRACKET FRONT RIGHT  [811] Up to ident. no.:	001	
164	A 001 990 78 91	NUT RETAINER BRACKET TO BUMPER  [811] Up to ident. no.:	002	
176	A 163 885 06 81	GRILLE AIR INLET Code: -U49  [811] Up to ident. no.:	001	
185	A 163 885 01 81	LICENSE PLATE MOULDING LICENSE PLATE MOUNTING Code: -(494/498)  [811] Up to ident. no.:	001	
185	A 163 885 01 81	LICENSE PLATE MOULDING LICENSE PLATE MOUNTING Code: 841-(494/498)  [820] As of ident. no.	001	
185	A 163 885 17 81	LICENSE PLATE MOULDING LICENSE PLATE MOUNTING Code: -(494/498)  [820] As of ident. no.	001	
191	A 163 885 03 81	LICENSE PLATE MOULDING LICENSE PLATE MOUNTING Code: 494  [420, 811] TO BE PAINTED PRIOR TO INSTALLATION	001	

191	A 163 885 03 81	LICENSE PLATE MOULDING LICENSE PLATE MOUNTING Code: 494+841 ☐ [420, 820] TO BE PAINTED PRIOR TO INSTALLATION	001
191	A 163 885 16 81	LICENSE PLATE MOULDING LICENSE PLATE MOUNTING Code: 494 ☐ [820] As of ident. no.	001
191	A 163 885 04 81	LICENSE PLATE MOULDING LICENSE PLATE MOUNTING Code: 498 ☐ [811] Up to ident. no.:	001
191	A 163 885 04 81	LICENSE PLATE MOULDING LICENSE PLATE MOUNTING Code: 498+U48 ☐ [811] Up to ident. no.:	001
191	A 163 885 04 81	LICENSE PLATE MOULDING LICENSE PLATE MOUNTING Code: (498/263)+841 ☐ [820] As of ident. no.	001
191	A 163 885 18 81	LICENSE PLATE MOULDING LICENSE PLATE MOUNTING Code: 498/263 ☐ [820] As of ident. no.	001





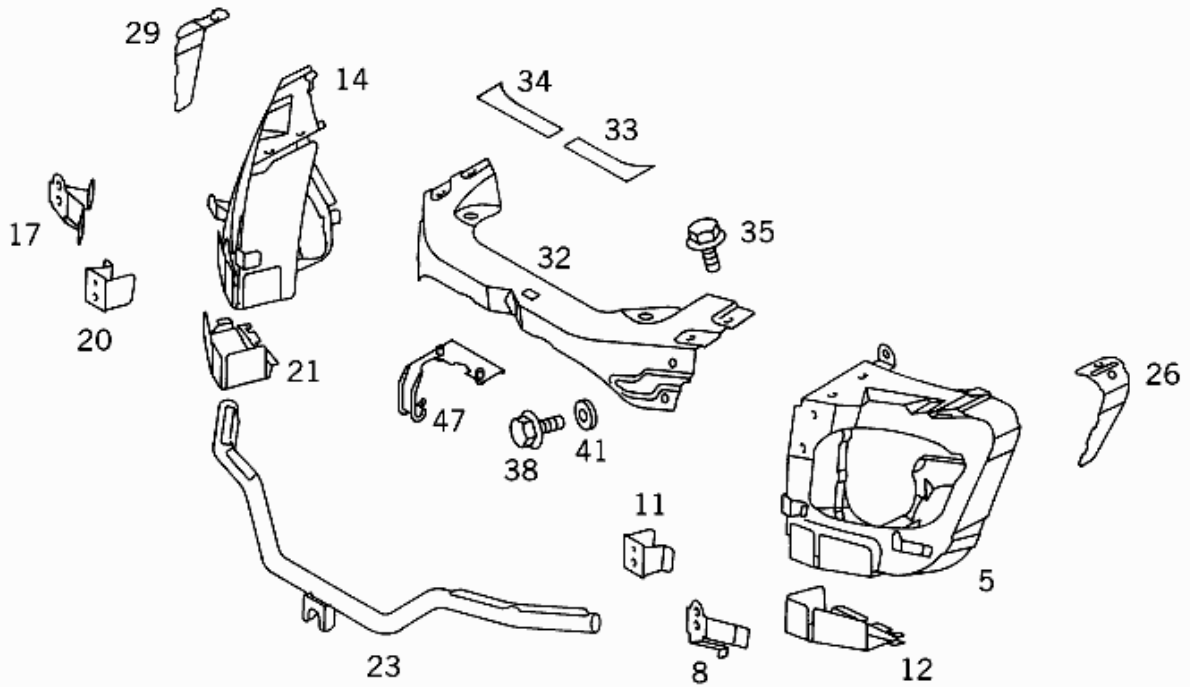





- Picture -

Mode	MD mode	Mod. des. overview	M-CLASS FROM IDENT NO. A221506 / X734088 WITH CODE 801
FIN/MD	163154	Catalog	06H -As of date 09/2000
VIN		Major assembly:	
Sales designation	ML 320	Major assembly MD	
Assortment class	Car	Group	62 - FRONT PANEL
Market	Europe	Subgroup	015 - COWL
Picture number	B62015000059.011204		



- Parts list -

Mode	MD mode	Mod. des. overview	M-CLASS FROM IDENT NO. A221506 / X734088 WITH CODE 801
FIN/MD	163154	Catalog	06H -As of date 09/2000
VIN		Major assembly:	
Sales designation	ML 320	Major assembly MD	
Assortment class	Car	Group	62 - FRONT PANEL
Market	Europe	Subgroup	015 - COWL

Item no.	Part number	Designation/description	Quantity	Version
5	A 163 620 09 91	SHELL FRONT LEFT  [811] Up to ident. no.:	001	
8	A 163 626 05 14	BRACKET OUTSIDE LEFT  [811] Up to ident. no.:	001	
12	A 163 610 11 25	REINFORCEMENT FRONT LEFT  [811] Up to ident. no.:	001	
14	A 163 620 06 91	SHELL FRONT RIGHT  [811] Up to ident. no.:	001	
17	A 163 626 06 14	BRACKET OUTSIDE RIGHT  [811] Up to ident. no.:	001	
20	A 163 626 08 14	BRACKET INSIDE RIGHT  [811] Up to ident. no.:	001	
21	A 163 610 12 25	REINFORCEMENT FRONT RIGHT  [811] Up to ident. no.:	001	
23	A 163 620 04 16	REINFORCEMENT BOTTOM  [811] Up to ident. no.:	001	
26	A 163 626 13 16	REINFORCEMENT WHEELHOUSE, FRONT LEFT	001	
29	A 163 626 14 16	REINFORCEMENT WHEELHOUSE, FRONT RIGHT	001	
32	A 163 620 05 16	REINFORCEMENT Replaced by: A 163 620 06 16 +001 A 163 880 06 60	-	
32	A 163 620 06 16	REINFORCEMENT ON UPPER FRAME CROSS MEMBER  [002] AFTER PAINTING,ATTACH FOILS 163 698 15 89, A 163 698 16 89	001	
33	A 163 698 15 89	ORNAMENTAL COVER LEFT REINFORCEMENT Code: -(P29/P37)  [003] USED WITH OUTSIDE PAINTWORK NO. 1693, NO. 9149,NO. 974...	001	
34	A 163 698 16 89	ORNAMENTAL COVER RIGHT REINFORCEMENT Code: -(P29/P37)  [003] USED WITH OUTSIDE PAINTWORK NO. 1693, NO. 9149,NO. 974...	001	
47	A 163 887 04 45	DEFLECTOR SAFETY HOOK	001	





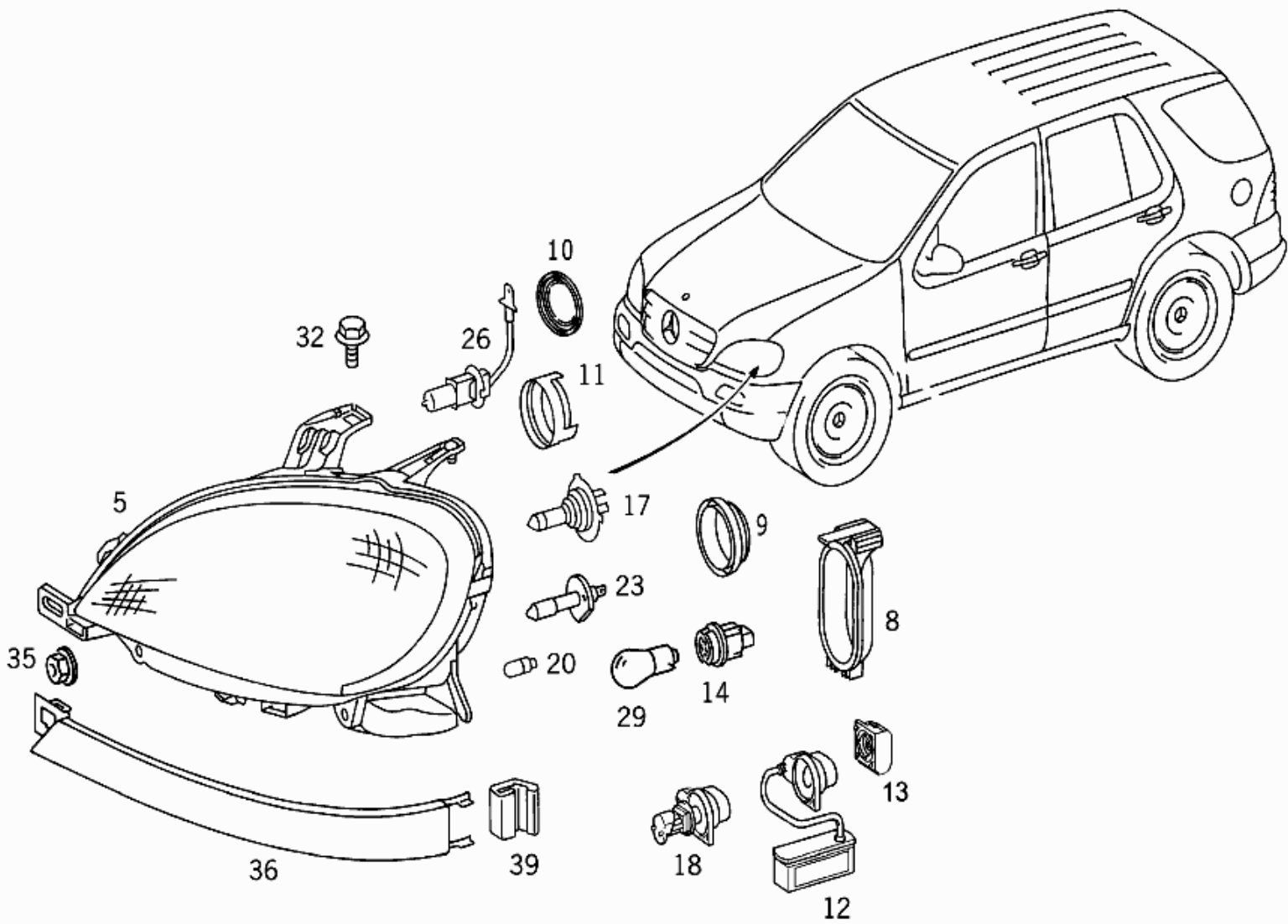







- Picture -

Mode	MD mode	Mod. des. overview	M-CLASS FROM IDENT NO. A221506 / X734088 WITH CODE 801
FIN/MD	163154	Catalog	06H -As of date 09/2000
VIN		Major assembly:	
Sales designation	ML 320	Major assembly MD	
Assortment class	Car	Group	82 - ELECTRICAL SYSTEM
Market	Europe	Subgroup	175 - FRONT LIGHTING
Picture number	B82175000243.110524		



- Parts list -

Mode	MD mode	Mod. des. overview	M-CLASS FROM IDENT NO. A221506 / X734088 WITH CODE 801
FIN/MD	163154	Catalog	06H -As of date 09/2000
VIN		Major assembly:	
Sales designation	ML 320	Major assembly MD	
Assortment class	Car	Group	82 - ELECTRICAL SYSTEM
Market	Europe	Subgroup	175 - FRONT LIGHTING

Item no.	Part number	Designation/description	Quantity	Version
5	A 163 820 37 61	LIGHTING UNIT LEFT,RIGHT-SIDE TRAFFIC  [811] Up to ident. no.:	001	
5	A 163 820 38 61	LIGHTING UNIT RIGHT,RIGHT-SIDE TRAFFIC  [811] Up to ident. no.:	001	
5	A 163 820 41 61	LIGHTING UNIT LEFT,RIGHT-SIDE TRAFFIC Code: 494  [811] Up to ident. no.:	001	
5	A 163 820 42 61	LIGHTING UNIT RIGHT,RIGHT-SIDE TRAFFIC Code: 494  [811] Up to ident. no.:	001	
5	A 163 820 13 61	LIGHTING UNIT LEFT,RIGHT-SIDE TRAFFIC Code: U49  [811] Up to ident. no.:	001	
5	A 163 820 14 61	LIGHTING UNIT RIGHT,RIGHT-SIDE TRAFFIC Code: U49  [811] Up to ident. no.:	001	
5	A 163 820 09 61	LIGHTING UNIT LEFT,RIGHT-SIDE TRAFFIC Code: U49+494  [811] Up to ident. no.:	001	
5	A 163 820 10 61	LIGHTING UNIT RIGHT,RIGHT-SIDE TRAFFIC Code: U49+494  [811] Up to ident. no.:	001	
5	A 163 820 17 61	LIGHTING UNIT LEFT,RIGHT-SIDE TRAFFIC XENON-LIGHTS Code: 612+U49  [811] Up to ident. no.:	001	
5	A 163 820 18 61	LIGHTING UNIT RIGHT,RIGHT-SIDE TRAFFIC XENON-LIGHTS Code: 612+U49  [811] Up to ident. no.:	001	
5	A 163 820 21 61	LIGHTING UNIT LEFT,RIGHT-SIDE TRAFFIC XENON-LIGHTS Code: 612+U49+494  [811] Up to ident. no.:	001	
5	A 163 820 22 61	LIGHTING UNIT RIGHT,RIGHT-SIDE TRAFFIC XENON-LIGHTS Code: 612+U49+494  [811] Up to ident. no.:	001	

5	A 163 820 43 61	LIGHTING UNIT LEFT,RIGHT-SIDE TRAFFIC Code: 460+494 <input type="checkbox"/> [811] Up to ident. no.:	001
5	A 163 820 44 61	LIGHTING UNIT RIGHT,RIGHT-SIDE TRAFFIC Code: 460+494 <input type="checkbox"/> [811] Up to ident. no.:	001
5	A 163 820 39 61	LIGHTING UNIT LEFT,LEFT-SIDE TRAFFIC Code: 613/498/625 <input type="checkbox"/> [811] Up to ident. no.:	001
5	A 163 820 40 61	LIGHTING UNIT RIGHT,LEFT-SIDE TRAFFIC Code: 613/498/625 <input type="checkbox"/> [811] Up to ident. no.:	001
5	A 163 820 11 61	LIGHTING UNIT LEFT,LEFT-SIDE TRAFFIC Code: U49+(613/498/625) <input type="checkbox"/> [811] Up to ident. no.:	001
5	A 163 820 12 61	LIGHTING UNIT RIGHT,LEFT-SIDE TRAFFIC Code: U49+(613/498/625) <input type="checkbox"/> [811] Up to ident. no.:	001
5	A 163 820 19 61	LIGHTING UNIT LEFT,LEFT-SIDE TRAFFIC XENON-LIGHTS Code: 617+U49 <input type="checkbox"/> [811] Up to ident. no.:	001
5	A 163 820 20 61	LIGHTING UNIT RIGHT,LEFT-SIDE TRAFFIC XENON-LIGHTS Code: 617+U49 <input type="checkbox"/> [811] Up to ident. no.:	001
5	A 163 820 45 61	LIGHTING UNIT LEFT,RIGHT-SIDE TRAFFIC Code: -494 <input type="checkbox"/> [820] As of ident. no.	001
5	A 163 820 46 61	LIGHTING UNIT RIGHT,RIGHT-SIDE TRAFFIC Code: -494 <input type="checkbox"/> [820] As of ident. no.	001
5	A 163 820 47 61	LIGHTING UNIT LEFT,LEFT-SIDE TRAFFIC Code: 613/498/625 <input type="checkbox"/> [820] As of ident. no.	001
5	A 163 820 48 61	LIGHTING UNIT RIGHT,LEFT-SIDE TRAFFIC Code: 613/498/625 <input type="checkbox"/> [820] As of ident. no.	001
5	A 163 820 49 61	LIGHTING UNIT LEFT,RIGHT-SIDE TRAFFIC Code: 494 <input type="checkbox"/> [820] As of ident. no.	001
5	A 163 820 50 61	LIGHTING UNIT RIGHT,RIGHT-SIDE TRAFFIC Code: 494 <input type="checkbox"/> [820] As of ident. no.	001
5	A 163 820 51 61	LIGHTING UNIT LEFT,RIGHT-SIDE TRAFFIC BI-XENON LIGHTS Code: 612/614 <input type="checkbox"/> [820] As of ident. no.	001
5	A 163 820 52 61	LIGHTING UNIT RIGHT,RIGHT-SIDE TRAFFIC BI-XENON LIGHTS Code: 612/614 <input type="checkbox"/> [820] As of ident. no.	001

5	A 163 820 53 61	LIGHTING UNIT LEFT,LEFT-SIDE TRAFFIC BI-XENON LIGHTS Code: 618  [820] As of ident. no.	001
5	A 163 820 54 61	LIGHTING UNIT RIGHT,LEFT-SIDE TRAFFIC BI-XENON LIGHTS Code: 618  [820] As of ident. no.	001
5	A 163 820 55 61	LIGHTING UNIT LEFT,RIGHT-SIDE TRAFFIC BI-XENON LIGHTS Code: 614+494  [820] As of ident. no.	001
5	A 163 820 56 61	LIGHTING UNIT RIGHT,RIGHT-SIDE TRAFFIC BI-XENON LIGHTS Code: 614+494  [820] As of ident. no.	001
36	A 163 826 01 77	MOLDING ORNAMENTAL COVER BELOW LIGHTING UNIT, LEFT  [004, 925] Color footnote	001
36	A 163 826 02 77	ORNAMENTAL COVER ORNAMENTAL COVER BELOW LIGHTING UNIT, RIGHT  [004, 925] Color footnote	001

- Picture -

Mode	MD mode	Mod. des. overview	M-CLASS FROM IDENT NO. A221506 / X734088 WITH CODE 801
FIN/MD	163154	Catalog	06H -As of date 09/2000
VIN		Major assembly:	
Sales designation	ML 320	Major assembly MD	
Assortment class	Car	Group	69 - COVERING AND LINING
Market	Europe	Subgroup	060 - OUTSIDE ATTACHMENT PARTS
Picture number	B69060000258.080815		

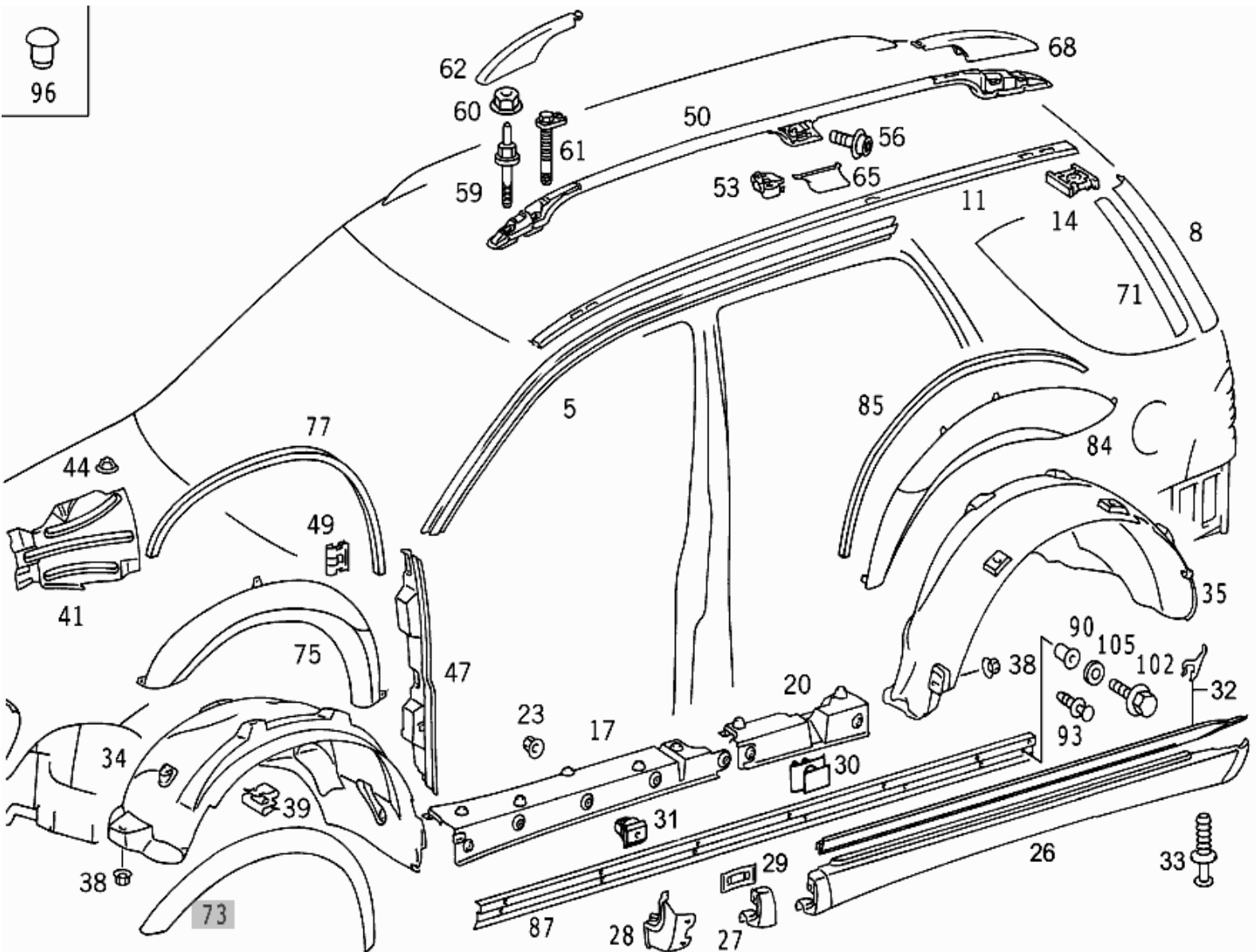

- Parts list -

Mode	MD mode	Mod. des. overview	M-CLASS FROM IDENT NO. A221506 / X734088 WITH CODE 801
FIN/MD	163154	Catalog	06H -As of date 09/2000
VIN		Major assembly:	
Sales designation	ML 320	Major assembly MD	
Assortment class	Car	Group	69 - COVERING AND LINING
Market	Europe	Subgroup	060 - OUTSIDE ATTACHMENT PARTS

Item no.	Part number	Designation/description	Quantity	Version
34	A 163 884 05 22	COVERING Replaced by: A 163 884 07 22	-	
34	A 163 884 07 22	COVERING FRONT LEFT	001	
34	A 163 884 06 22	COVERING Replaced by: A 163 884 08 22	-	
34	A 163 884 08 22	COVERING FRONT RIGHT	001	
47	A 163 880 01 24	COVERING LEFT	001	
47	A 163 880 02 24	COVERING RIGHT	001	

- Picture -

Mode	MD mode	Mod. des. overview	M-CLASS FROM IDENT NO. A221506 / X734088 WITH CODE 801
FIN/MD	163154	Catalog	06H -As of date 09/2000
VIN		Major assembly:	
Sales designation	ML 320	Major assembly MD	
Assortment class	Car	Group	42 - BRAKES
Market	Europe	Subgroup	030 - FRONT WHEEL BRAKE
Picture number	B42030000078.080429		

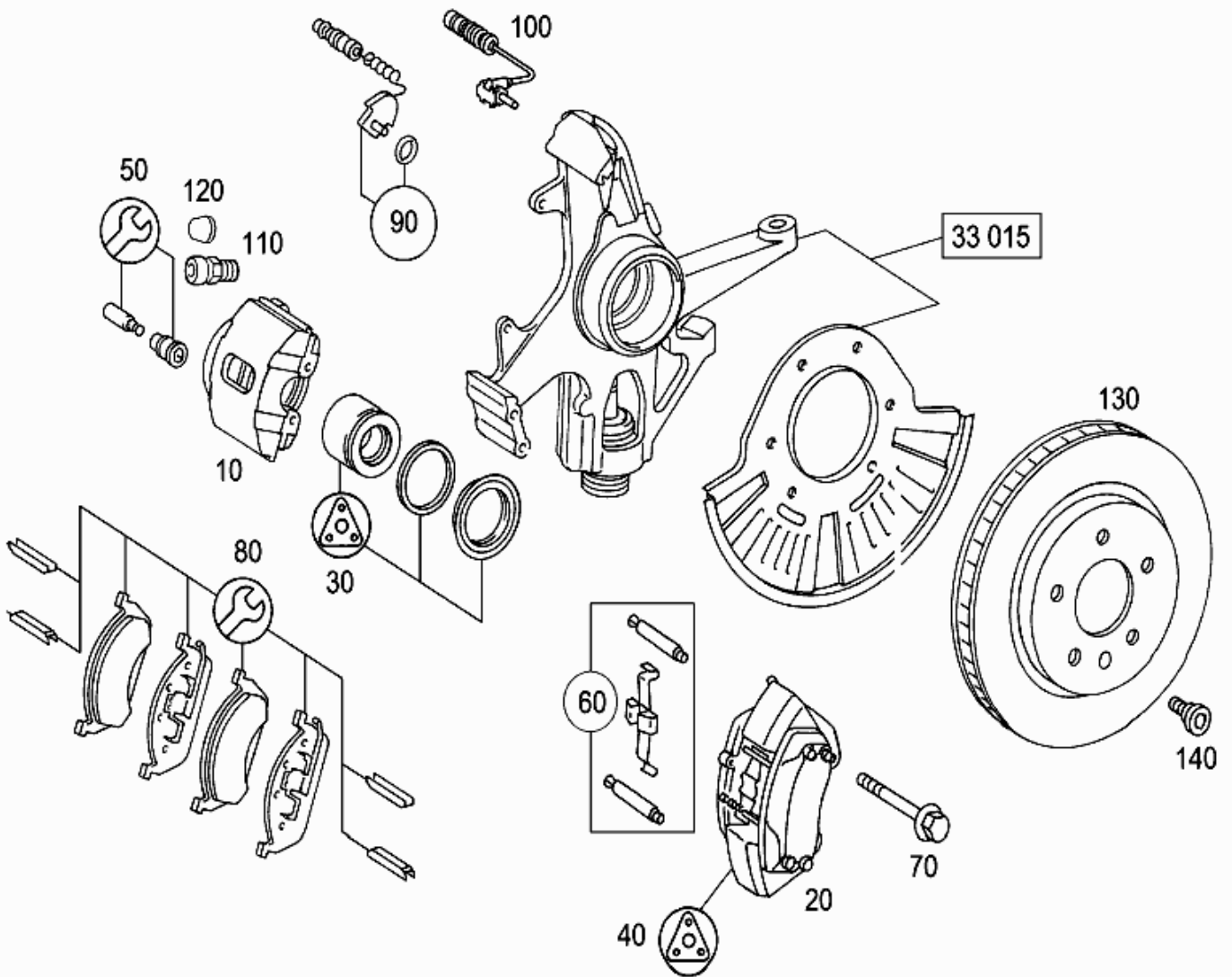

- Parts list -

Mode	MD mode	Mod. des. overview	M-CLASS FROM IDENT NO. A221506 / X734088 WITH CODE 801
FIN/MD	163154	Catalog	06H -As of date 09/2000
VIN		Major assembly:	
Sales designation	ML 320	Major assembly MD	
Assortment class	Car	Group	42 - BRAKES
Market	Europe	Subgroup	030 - FRONT WHEEL BRAKE

Item no.	Part number	Designation/description	Quantity	Version
130	A 163 421 02 12	BRAKE DISC Optional with: A 163 421 04 12 Code: -494 <input type="checkbox"/> [811] Up to ident. no.:	002	
130	A 163 421 04 12	BRAKE DISC Optional with: A 163 421 02 12 Code: -494 <input type="checkbox"/> [811] Up to ident. no.:	002	
130	A 163 421 02 12	BRAKE DISC Optional with: A 163 421 04 12 Code: 494	002	
130	A 163 421 04 12	BRAKE DISC Optional with: A 163 421 02 12 Code: 494	002	
130	A 163 421 03 12	BRAKE DISC Replaced by: A 163 421 05 12 Code: -494 <input type="checkbox"/> [820] As of ident. no.:	002	
130	A 163 421 05 12	BRAKE DISC Code: -494 <input type="checkbox"/> [820] As of ident. no.:	002	