

|                  |  |          |
|------------------|--|----------|
| AR82.70-P-0005GH | Fiber optical cable (D2B) replace complete (after testing) | 24.10.02 |
|------------------|--|----------|

MODEL 163.154 /172 #A as of 221506,  
 163.157 /174 /175  
 with CODE (494a) USA version  
 with CODE (819) 6-disk CD changer

**Components of USA version**

A2/6 CD player with changer (in trunk)  
 A2/13 Sound amplifier  
 A2/56 Radio and navigation unit  
 A35/8 E-call control module

rt= red  
 ws=white

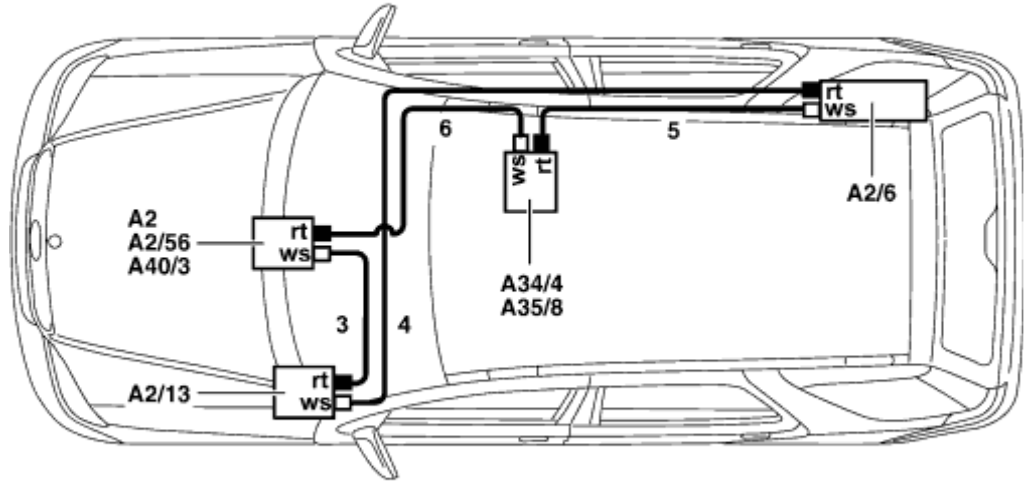

P82.64-2421-06

3 Fiber optical cable module 1  
 4 Fiber optical cable module 2  
 5 Fiber optical cable module 3  
 6 Fiber optical cable module 4  
 rt Insert, red  
 ws Insert, white

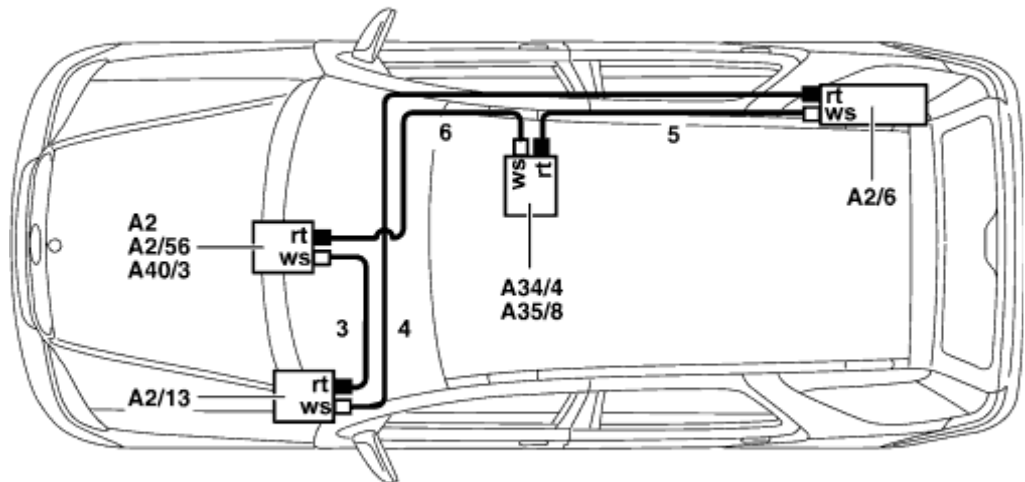

P82.64-2421-06





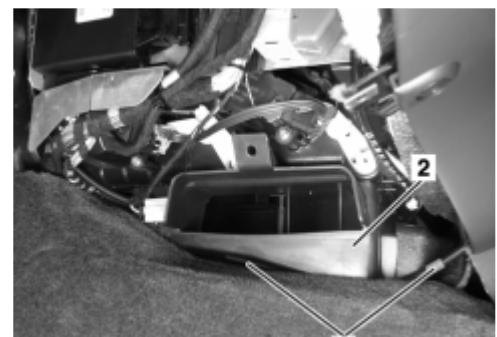
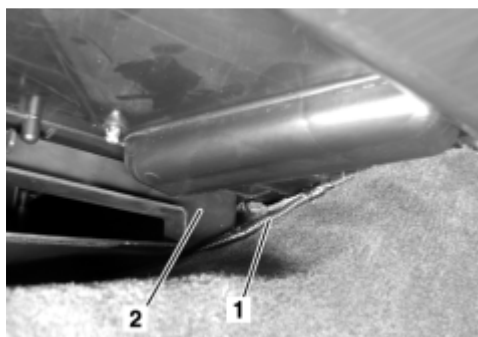





**The cover on the left under the instrument panel removed for a better display**

1 Exchange D2 B-wiring harness  
 2 Heater housing



P82.70-4474-01

P82.70-4475-01

|   |   |  |                                    |
|---|---|--|------------------------------------|
|    | <b>Remove</b>   |  |                                    |
|    | Notes on fiber optic cable  |  | <a href="#">AH82.70-P-0001-02A</a> |
| 1   | Remove radio  |  | <a href="#">AR82.60-P-7502EA</a>   |
| 2   | Cut through the existing D2B wiring harness as far as possible from the connector on the radio  |  |                                    |
| 3   | Remove cover on right under the instrument panel  |  Left hand steering vehicle up to 31.8.99.  | <a href="#">AR68.10-P-1520GH</a>   |
|   |   |  Left hand steering vehicle as of 1.9.99.   | <a href="#">AR68.10-P-1520GI</a>   |
| 4   | Remove right-hand side entrance strip   |  | <a href="#">AR68.30-P-4100GH</a>   |
| 5   | Remove footwell cover on right  |  | <a href="#">AR68.30-P-4010GH</a>   |
| 6   | Unscrew the bolt for the outer rear seat belt on the right side   |  |                                    |
| 7   | Remove the front load compartment hooks on the right C-pillar   |  |                                    |
| 8   | Remove load compartment cover and unscrew the bolt in the bracket   |  |                                    |
| 9   | Remove cover for the CD changer and unscrew bolt behind the cover in the top left corner  |  |                                    |
| 10  | Disconnect D2B plug from CD changer and unclip the wiring harness from the bracket  |  |                                    |
| 11  | Remove the existing D2B wiring harness between the CD changer and firewall at the transmission tunnel   |  Cut off the existing D2B wiring harness at the last tie strap between the heater housing and firewall.<br><b>Only if the D2B wiring harness is NOT in the interior wiring harness.</b> |                                    |
|  | <b>Install</b>  |  |                                    |
| 12  | Plug the plug of the new D2B wiring harness into the CD changer and route the wiring harness along the feed hose of the liftgate washer system to the front edge of the C-pillar paneling |  <b>Risk of breakage!</b> Do not kink or stretch fiber optic cable Before routing, push the caps onto the fiber optical cable.  |                                    |
|   |   |  Fasten the wiring harness to the CD changer bracket. Pull the C-pillar paneling away from the body for better accessibility.   |                                    |
| 13  | Route the new D2B wiring harness along the feed hose of the liftgate washer system up to the right A-pillar   |  Fasten the D2B wiring harness to the body with inline clips.   |                                    |
| 14  | Route the new D2B wiring harness along the vehicle wiring harness from the right footwell to the top side of the transmission tunnel to the firewall                                      |  Fasten the D2B wiring harness to the vehicle wiring harness using tie straps.  |                                    |
| 15  | Route the exchange D2B wiring harness (1) on the carpet, through under the heater housing (2) to the left side  |  |                                    |
| 16  | Route exchange D2B wiring harness (1) to the radio installation opening   |  D2Fasten the B-wiring harness to the vehicle wiring harness using tie straps.  |                                    |
| 17  | Screw the screw into the top left corner behind the cover for the CD-changer  |  |                                    |
| 18  | Screw the screw into the bracket of the load compartment cover and install the load compartment cover   |  |                                    |

|    |   |  |                                    |
|----|---|--|------------------------------------|
| 19 | Install the front load compartment hooks on the right C-pillar    |  |                                    |
| 20 | Screw in the screw for the outer rear seat belt on the right side | <b>Nm</b>  | <a href="#">BA91.40-P-1001-01D</a> |
| 21 | Install right footwell cover                                      |  | <a href="#">AR68.30-P-4010GH</a>   |
| 22 | Install right door sill molding                                   |  | <a href="#">AR68.30-P-4100GH</a>   |
| 23 | Install the cover on the right under the instrument panel         | <b>i</b> Left hand steering vehicle up to 31.8.99. | <a href="#">AR68.10-P-1520GH</a>   |
|    |   | <b>i</b> Left hand steering vehicle as of 1.9.99.  | <a href="#">AR68.10-P-1520GI</a>   |
| 24 | Install radio   |  | <a href="#">AR82.60-P-7502EA</a>   |

**Nm** Seat belts/emergency tensioning retractors

| Number             | Designation               |    | Model 163 as of 09/99 |
|--------------------|---------------------------|----|-----------------------|
| BA91.40-P-1001-01D | Screw on belt end fitting | Nm | 35                    |