

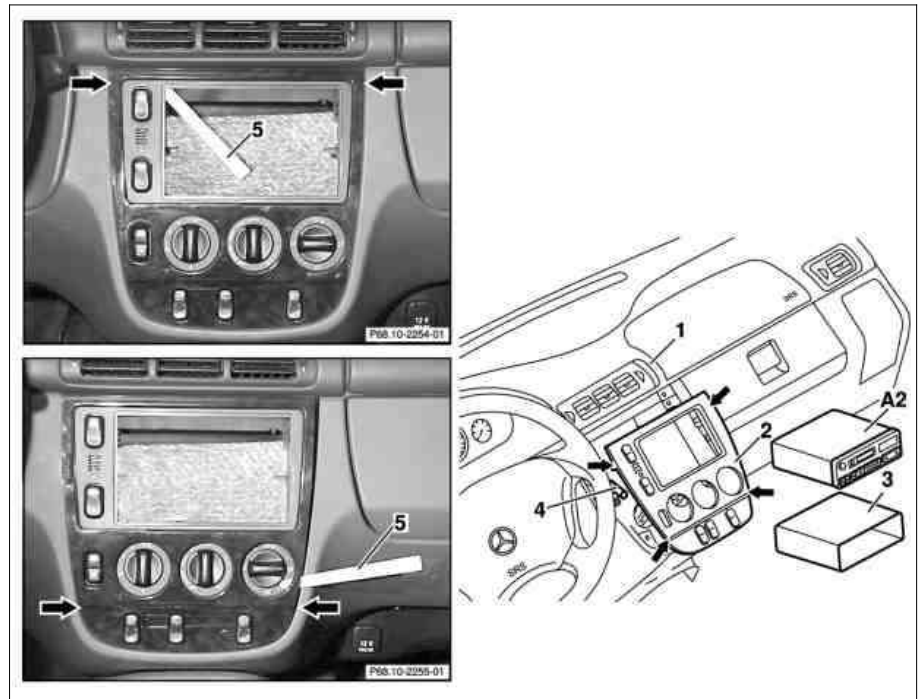









MODEL 163.113 /128 /136 /154 /157 /172 /174 /175

Illustrated on Model 163 up to VIN
A289564, X754619

- 1 Instrument panel
 2 Instrument panel center section
 3 Stowage compartment
 4 In-car temperature sensor intake hose
 5 Long wedge
 A2 Radio
 Arrows Retaining clips



P68.10-2358-06

	Remove/install		
1	Remove radio (A2)		AR82.60-P-7502EA
2.1	Remove stowage compartment (3)	 Only if present	
3	Pry off top retaining clips (arrows) at center section of instrument panel (2) out of instrument panel (1)	 Risk of cracks and fracture!  Put long wedge (5) behind center section of instrument panel (2) on the top edges of the opening and carefully pry off top retaining clips (arrows).  Long wedge	*115589035900
4	Insert long wedge (5) into gap between instrument panel center section (2) and instrument panel (1) and pull down to rotary switches	 Long wedge	*115589035900
5	Carefully pry off bottom retaining clips (arrows) at center section of instrument panel (2) out of instrument panel (1)	 Risk of cracks and fracture!  Long wedge	*115589035900
6.1	Pull off interior temperature sensor intake hose (4)	 Up to VIN A289564, X754619.	
7	Unplug all connectors from center section of instrument panel (2).		
8.1	Separate connectors from AAC pushbutton control module	 As of VIN A289565, X754620.	
9	Remove instrument panel center section (2)		
10	Install in the reverse order		

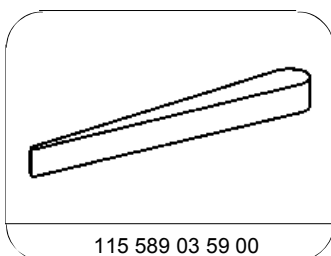

115 589 03 59 00

Long wedge