

PDF Compressor Free Version



Operator's Manual
M-Class



1645841481

Order No. 6515 4243 13 Part No. 164 584 14 81 USA Edition C , 2006

Operator's Manual M-Class



Mercedes-Benz

PDF Compressor Free Version

ML 350

ML 500

PDF Compressor Free Version

Our company and staff congratulate you on the purchase of your new Mercedes-Benz.

Your selection of our product is a demonstration of your trust in our company name. Furthermore, it exemplifies your desire to own an automobile that will be as easy as possible to operate and provide years of service.

Your Mercedes-Benz represents the efforts of many skilled engineers and craftsmen. To help assure your driving pleasure, and also the safety of you and your passengers, we ask you to make a small investment of time:

- Please read this manual carefully, then return it to your vehicle where it will be handy for your reference.
- Please follow the recommendations contained in this manual. They are designed to acquaint you with the operation of your Mercedes-Benz.
- Please pay attention to the warnings and cautions contained in this manual. They are designed to help improve the safety of the vehicle operator and occupants.

We extend our best wishes for many miles of safe, pleasurable driving.

Mercedes-Benz USA, LLC
A DaimlerChrysler Company

Contents

Introduction	9	At a glance	21	Getting started	31
Product information.....	9	Cockpit.....	22	Unlocking	32
Operator’s Manual.....	10	Instrument cluster	24	Unlocking with the SmartKey	32
Service and warranty information ..	10	Multifunction steering wheel	26	Unlocking with KEYLESS-GO*	33
Important notice for California		Center console	27	Starter switch positions.....	34
retail buyers and lessees of		Upper part	27	Adjusting	38
Mercedes-Benz automobiles	11	Lower part	28	Seats	38
Maintenance	12	Overhead control panel	29	Steering wheel.....	41
Roadside Assistance	12	Door control panel.....	30	Mirrors.....	43
Change of address or ownership....	13			Driving.....	46
Operating your vehicle				Fastening the seat belts	46
outside the USA or Canada.....	13			Starting the engine	49
Where to find it.....	15			Parking brake	52
Symbols.....	16			Driving	52
Operating safety	17			Switching on headlamps.....	54
Proper use of the vehicle	17			Turn signals	54
Problems with your vehicle.....	18			Windshield wipers.....	55
Reporting safety defects.....	19			Rear window wiper/washer	57
Reporting safety defects	19			Problems while driving.....	58
Vehicle data recording.....	20			Parking and locking.....	60
Information regarding electronic				Parking brake	61
recording devices.....	20			Switching off headlamps.....	62
				Turning off engine.....	62

Contents

Safety and Security	65	Controls in detail	105	Memory function*	135
Occupant safety.....	66	Locking and unlocking.....	106	Storing positions in memory	136
Air bags	67	SmartKey	106	Recalling positions	
Seat belts	73	SmartKey with KEYLESS-GO*	110	from memory	136
Preventive occupant safety*		Opening the doors		Storing exterior rear	
(PRE-SAFE) [®]	77	from the inside	117	view mirror parking position	137
Children in the vehicle.....	78	Opening the tailgate.....	118	Lighting	138
Blocking of rear door		Closing the tailgate	120	Exterior lamp switch	138
window operation.....	89	Automatic central locking	125	Combination switch	142
Panic alarm.....	91	Locking and unlocking		Corner-illuminating	
Activating	92	from the inside	126	front fog lamps*	143
Deactivating	92	Seats	128	Hazard warning flasher	144
Driving safety systems.....	93	Easy-entry/exit feature		Interior lighting	145
ABS	93	(Vehicles with		Door entry lamps	147
BAS	95	memory function*).....	128	Instrument cluster	148
ESP [®]	95	Lumbar support.....	130	Instrument cluster illumination	148
EBP.....	98	Rear seat head restraints.....	130	Trip odometer	149
4-ETS.....	98	Multicontour seat*	132	Tachometer	149
Anti-theft systems.....	100	Seat heating*	133	Outside temperature indicator	149
Immobilizer.....	100				
Anti-theft alarm system	100				
Tow-away alarm	102				

Contents

Control system	150	Transfer case	193	3-zone automatic climate control*	216
Multifunction display	150	Good visibility	194	Deactivating the	
Multifunction steering wheel	151	Headlamp cleaning system*	194	climate control system	220
Menus	153	Rear view mirrors	194	Rear air conditioning	221
Standard display menu	156	Power folding exterior		Setting the temperature	221
AUDIO menu	157	rear view mirrors*	197	Adjusting air distribution	222
NAV* menu	158	Sun visors	198	Adjusting air volume	222
Off-road menu	159	Rear window defroster	200	Maximum cooling MAX COOL	223
Vehicle status message		Climate control	202	Defrosting	223
memory menu	159	Deactivating the		Air recirculation mode	223
Settings menu	161	climate control system	206	Air conditioning	225
Vehicle configuration	175	Rear air conditioning	206	Residual heat and ventilation	226
Trip computer menu	177	Setting the temperature	207	Rear air conditioning	227
TEL menu*	178	Adjusting air distribution	207	Power windows	230
Automatic transmission	182	Adjusting air volume	208	Opening and closing	
Gear selector lever	182	Defrosting	208	the windows	230
Shifting procedure	184	Air recirculation mode	209	Synchronizing power windows	232
Transmission positions	185	Air conditioning	211	Summer opening feature	233
Gear ranges	187	Residual heat and ventilation	212	Convenience closing feature	234
Steering wheel gearshift control ..	188	Rear air conditioning	213	Power tilt/sliding sunroof*	235
Shifting into optimal gear range ...	190			Opening and closing the power	
Canceling gear range limit	190			tilt/sliding sunroof	235
Driving tips	190			Synchronizing the	
Towing a trailer	191			power tilt/sliding sunroof	237
Emergency operation					
(Limp Home Mode)	192				

Contents

Driving systems	238	Useful features	270	Operation	297
Cruise control.....	238	Storage compartments	270	The first 1000 miles (1500 km)	298
Downhill Speed Regulation		Cup holders.....	274	Driving instructions	299
(DSR).....	243	Armrest in rear seat bench.....	275	Drive sensibly – save fuel.....	299
Off-road driving program	248	Ashtrays*	275	Drinking and driving.....	299
Air suspension package*	249	Cigarette lighter*	277	Pedals	299
Adaptive Damping System		12-V sockets.....	277	Power assistance	299
(ADS)*	249	Floor mats*	279	Brakes.....	300
Vehicle level control*	250	Telephone*	279	Driving off	301
Parktronic* system		Tele Aid*	280	Parking.....	301
(Parking assist).....	254	Garage door opener	289	Tires.....	302
Loading.....	259	Compass	295	Hydroplaning.....	303
Loading instructions.....	259	Infrared reflecting windshield*	296	Tire traction	303
, Split rear bench seat	261			Tire speed rating	303
Partition net*	263			Winter driving instructions	304
Cargo compartment cover*	265			Standing water.....	305
Cargo management system*	265			Off-road driving.....	306
Roof rack*	269			Trailer towing	314
				Passenger compartment.....	319
				Driving abroad	319
				Control and operation of radio	
				transmitters	320
				Catalytic converter.....	320
				Emission control	321
				Coolant temperature.....	322

Contents

At the gas station	323	Maximum tire load	361	Practical hints	381
Refueling	323	Maximum tire inflation pressure ...	362	What to do if	382
Check regularly and		Uniform Tire Quality Grading		Lamps in instrument cluster	382
before a long trip.....	324	Standards (U.S. vehicles).....	362	Lamp in center console	393
Engine compartment	326	Tire ply material	364	Vehicle status messages in the	
Hood	326	Tire and loading terminology.....	365	multifunction display	395
Engine oil	327	Rotating tires	368	Where will I find ...?	430
Transmission fluid level.....	332	Winter driving	369	First aid kit.....	430
Coolant level	332	Winter tires	369	Vehicle tool kit.....	430
Windshield/rear window		Block heater (Canada only).....	370	Spare wheel.....	433
washer system and		Snow chains.....	370	Unlocking/locking in an emergency ..	435
headlamp cleaning system*	333	Maintenance.....	371	Unlocking the vehicle	435
Tires and wheels.....	335	Clearing the maintenance		Locking the vehicle	436
Important guidelines	335	service indicator	372	Unlocking and opening	
Tire care and maintenance.....	336	Maintenance service		the tailgate	437
Direction of rotation.....	338	term exceeded.....	372	Fuel filler flap.....	438
Loading the vehicle	338	Calling up the service indicator.....	372	Opening/closing in an emergency	439
Recommended tire		Resetting the		Power tilt/sliding sunroof*	439
inflation pressure	345	maintenance service indicator	373	Replacing SmartKey batteries	440
Checking tire inflation pressure ...	347	Vehicle care.....	374	SmartKey	440
Tire labeling.....	355	Cleaning and care of the vehicle...	374	SmartKey with KEYLESS-GO*	441
Load identification	359				
DOT, Tire Identification					
Number (TIN)	360				

Replacing bulbs	443	Fuses.....	477	Electrical system	490
Bulbs	443	Aids for changing fuses.....	478	Main Dimensions.....	491
Replacing bulbs for front lamps ...	445	Main fuse box	478	Weights	492
Replacing bulbs for rear lamps.....	450	Fuse box in		Fuels, coolants, lubricants, etc.....	493
Adjusting headlamp aim.....	451	cargo compartment	479	Capacities.....	493
Replacing wiper blades.....	453	Fuse box in		Engine oils	495
Removing front wiper blades.....	453	passenger compartment.....	479	Engine oil additives.....	495
Installing front wiper blades.....	453			Air conditioning refrigerant.....	495
Removing rear wiper blade.....	454			Brake fluid	495
Installing rear wiper blade.....	455	Technical data	481	Premium unleaded gasoline.....	496
Flat tire	456	Parts service.....	482	Fuel requirements.....	496
Preparing the vehicle	456	Warranty coverage	483	Gasoline additives.....	497
Mounting the spare wheel.....	457	Loss of Service and Warranty		Coolants	497
Battery.....	462	Information Booklet	483	Windshield washer and	
Disconnecting, removing,		Identification labels	484	headlamp cleaning* system	500
reinstalling and		Layout of poly-V-belt drive.....	485	Windshield and headlamp	
reconnecting the battery.....	464	ML 350	485	washer fluid mixing ratio.....	500
Charging the battery	469	ML 500	485		
Jump starting	470	Engine	486		
Towing the vehicle	472	Rims and tires	487	Technical terms	501
Installing towing eye bolt	474	Rims and tires.....	488		
Stranded vehicle	476	Minispare wheel.....	489	Index	507

▼ **Product information**

Please observe the following in your own best interest:

We recommend using genuine Mercedes-Benz parts as well as conversion parts and accessories explicitly approved by us for your vehicle model.

We have tested these parts to determine their reliability, safety and special suitability for Mercedes-Benz vehicles.

We are unable to make an assessment for other products and therefore cannot be held responsible for them, even if in individual cases an official approval or authorization by governmental or other agencies should exist. Use of such parts and accessories could adversely affect the safety, performance or reliability of your vehicle. Please do not use them.

Genuine Mercedes-Benz parts as well as conversion parts and accessories approved by us are available at your authorized Mercedes-Benz Light Truck Center where you will receive comprehensive information, also on permissible technical modifications, and where proper installation will be performed.

Introduction

Operator's Manual

This Operator's Manual contains a great deal of useful information. We urge you to read it carefully and familiarize yourself with the vehicle before driving.

For your own safety and longer service life of the vehicle, we urge you to follow the instructions and warnings contained in this manual. Ignoring them could result in damage to the vehicle or personal injury to you or others. Vehicle damage caused by failure to follow instructions is not covered by the Mercedes-Benz Limited Warranty.

Your vehicle may have some or all of the equipment described in this manual. Therefore, you may find explanations for optional equipment not installed in your vehicle. If you have any questions about the operation of any equipment, your authorized Mercedes-Benz Light Truck Center will be glad to demonstrate the proper procedures.

We continuously strive to improve our product, and ask for your understanding that we reserve the right to make changes in design and equipment. Therefore, information, illustrations and descriptions in this Operator's Manual might differ from your vehicle.

Optional equipment is also described in this manual, including operating instructions wherever necessary. Since they are special-order items, the descriptions and illustrations herein may vary slightly from the actual equipment of your vehicle.

If there are any equipment details that are not shown or described in this Operator's Manual, your authorized Mercedes-Benz Light Truck Center will be glad to inform you of correct care and operating procedures.

The Operator's Manual and Maintenance Booklet are important documents and should be kept with the vehicle.

Service and warranty information

The Service and Warranty Information Booklet contains detailed information about the warranties covering your Mercedes-Benz, including:

- New Light Truck Limited Warranty,
- Emission System Warranty,
- Emission Performance Warranty,
- California, Maine, Massachusetts, and Vermont Emission Control System Warranty (California, Maine, Massachusetts, and Vermont only),
- State Warranty Enforcement Laws (Lemon Laws).

Important notice for California retail buyers and lessees of Mercedes-Benz automobiles

Under California law you may be entitled to a replacement of your vehicle or a refund of the purchase price or lease price, if Mercedes-Benz USA, LLC and/or its authorized repair or service facilities fail to fix one or more substantial defects or malfunctions in the vehicle that are covered by its express warranty after a reasonable number of repair attempts. During the period of 18 months from original delivery of the vehicle or the accumulation of 18 000 miles (approx. 29 000 km) on the odometer of the vehicle, whichever occurs first, a reasonable number of repair attempts is presumed for a retail buyer or lessee if one or more of the following occurs:

- (1) the same substantial defect or malfunction results in a condition that is likely to cause death or serious bodily injury if the vehicle is driven, that defect or malfunction has been subject to repair two or more times, and you have directly notified Mercedes-Benz USA, LLC in writing of the need for its repair,
- (2) the same substantial defect or malfunction of a less serious nature than category (1) has been subject to repair four or more times and you have directly notified us in writing of the need for its repair, or
- (3) the vehicle is out of service by reason of repair of the same or different substantial defects or malfunctions for a cumulative total of more than 30 calendar days.

Written notification should be sent to us, not a dealer, at Mercedes-Benz USA, LLC, Customer Assistance Center, One Mercedes Drive, Montvale, NJ 07645-0350.

Introduction

Operator's Manual

Maintenance

The Maintenance Booklet describes all the necessary maintenance work which should be performed at regular intervals.

Always have the Maintenance Booklet with you when you take the vehicle to your authorized Mercedes-Benz Light Truck Center for service. The service advisor will record each service in the booklet for you.

Roadside Assistance

The Mercedes-Benz Roadside Assistance Program provides factory-trained technical help in the event of a breakdown. Calls to the toll-free Roadside Assistance number

1-800-FOR-MERCEdes (in the USA)
1-800-387-0100 (in Canada)

will be answered by Mercedes-Benz Customer Assistance Representatives 24 hours a day, 365 days a year.

Roadside Assistance will be provided in accordance with standard program guidelines which include providing service to the vehicle up to a reasonable distance from a paved roadway. We will make every effort to assist in a breakdown situation, however, the accessibility of your vehicle will be determined by our authorized Mercedes-Benz Light Truck Center technician or the tow service provider on a case-by-case basis and may be a factor in our ability to respond.

Additional charges may be applicable for a breakdown location determined not to be a reasonably accessible roadside location as determined by our authorized technician and tow service provider.

For additional information refer to the Mercedes-Benz Roadside Assistance Program brochure in your vehicle literature portfolio.

Change of address or ownership

If you change your address, be sure to send in the "Change of Address Notice" found in the Service and Warranty Information Booklet, or simply call the Mercedes-Benz Customer Assistance Center (in the USA) at 1-800-FOR-MERCEdes, or Customer Service (in Canada) at 1-800-387-0100. It is in your own interest that we can contact you should the need arise.

If you sell your Mercedes, please leave all literature with the vehicle to make it available to the next operator.

If you bought this vehicle used, be sure to send in the "Notice of Purchase of Used Truck" found in the Service and Warranty Information Booklet, or call the Mercedes-Benz Customer Assistance Center (in the USA) at 1-800-FOR-MERCEdes, or Customer Service (in Canada) at 1-800-387-0100.

Operating your vehicle outside the USA or Canada

If you plan to operate your vehicle in foreign countries, please be aware that:

- service facilities or replacement parts may not be readily available,
- unleaded gasoline for vehicles with catalytic converters may not be available; the use of leaded fuels will damage the catalysts,
- gasoline may have a considerably lower octane rating, and improper fuel can cause engine damage.

Certain Mercedes-Benz models are available for delivery in Europe under our European Delivery Program. For details, consult an authorized Mercedes-Benz Light Truck Center or write to:

In the USA:

Mercedes-Benz USA, LLC
European Delivery Department
One Mercedes Drive
Montvale, NJ 07645-0350

In Canada:

Mercedes-Benz Canada, Inc.
European Delivery Department
98 Vanderhoof Avenue
Toronto, Ontario M4G 4C9

Introduction

Operator's Manual

Warning!



This Sport Utility Vehicle is designed for both on-road and off-road use. It can go places and perform tasks for which conventional 2-wheel drive passenger cars are not intended. This vehicle will handle and maneuver differently from conventional passenger cars in driving conditions which may occur on streets, highways and off-road use.

This vehicle has a higher ground clearance and a higher center of gravity than many passenger cars. As with other vehicles of this type, if you make sharp turns at excessive speeds or abrupt maneuvers, the vehicle may roll over or may go out of control and crash. Utility vehicles have a significantly higher rollover rate than other types of vehicles. Failure to operate this vehicle safely may result in an accident, rollover of the vehicle, and severe or fatal injury.

Before you start to drive this vehicle, read the Operator's Manual. Take time to become familiar with the driving characteristics of this vehicle. Be sure you are familiar with all vehicle controls. Learn how your vehicle handles on different road surfaces. Do not attempt sharp turns at excessive speeds or abrupt maneuvers or other unsafe driving actions that can cause loss of vehicle control. When driving off-road or working the vehicle hard, do not overload it. And, always wear your seat belts at all times. In a rollover crash, an unbelted person is significantly more likely to die than a person wearing a seat belt.

▼ **Where to find it**

This Operator's Manual is designed to provide comprehensive support information for you, the vehicle operator. Each section has its own reference color.

At a glance

Here you will find an overview of all the controls that can be operated from the driver's seat.

Getting started

Here you will find all the information you need for your first drive. You should read this section first if this is your first Mercedes-Benz vehicle or if you are renting or borrowing this vehicle.

Safety and Security

Here you will find descriptions of the safety and security features of your vehicle.

Controls in detail

Here you will find detailed information about the equipment installed on your vehicle. This section expands on the "Getting started" section and also describes technical innovations. If you are already familiar with the basic functions of your vehicle, this section will be of particular interest to you.

Operation

Here you will find all the information you need for the proper operation of your vehicle.

Practical hints

This section provides fast assistance for dealing with problems you may encounter.

Introduction

Where to find it

Technical data

All important technical data for your vehicle can be found in this section.

Indexes

The glossary provides explanations of the most important technical terms.

The table of contents and the index are designed to help you find information quickly and easily.

The following publications are part of your vehicle documentation:

- this Operator's Manual
- the Maintenance Booklet

Separate operating instructions will be provided as required depending on the equipment options installed in your vehicle.

Introduction

Symbols

Registered trademarks®:

ESP® and PRE-SAFE® are registered trademarks of DaimlerChrysler.

The following symbols are found in this Operator's Manual:

- * Optional equipment is identified with an asterisk. Since standard equipment varies between models, the descriptions and illustrations in this manual may differ slightly from the actual equipment of your vehicle.

Warning!



Warning notices draw your attention to hazards that may endanger your health or life, or the health or life of others.



Highlights hazards that may result in damage to your vehicle.



Helpful hints or further information you may find useful.

- ▶ This symbol points to instructions for you to follow.
- ▶ A number of these symbols appearing in succession indicates a multiple-step procedure.
- ▷ Page This symbol tells you where to look for further information on a topic.
- ▷▷ This continuation symbol marks an interrupted procedure which will be continued on the next page.
- > In the glossary of technical terms, this symbol is used to indicate cross-references to term definitions.
- Display Words appearing in the multi-function display are printed in the type shown here.

▼ Operating safety

Warning!



Work improperly carried out on electronic components and associated software could cause them to cease functioning. Because the vehicle's electronic components are interconnected, any modifications made may produce an undesired effect on other systems. Electronic malfunctions could seriously impair the operating safety of your vehicle.

See an authorized Mercedes-Benz Light Truck Center for repairs or modifications to electronic components.

Other improper work or modifications on the vehicle could also have a negative impact on the operating safety of the vehicle.

Some safety systems only function while the engine is running. You should therefore never turn off the engine while driving.

Warning!



Heavy blows against the vehicle underbody or tires/wheels, for example when running over an obstacle, road debris or a pothole, may cause serious damage and impair the operating safety of your vehicle. If you feel a sudden significant vibration or ride disturbance, or you suspect that damage to your vehicle has occurred, you should turn on your hazard warning flashers, carefully slow down, and drive with caution to an area which is a safe distance from the road.

Inspect the vehicle underbody and tires/wheels for possible damage. If the vehicle appears unsafe, have it towed to the nearest authorized Mercedes-Benz Light Truck Center or other qualified maintenance or repair facility for further inspection or repairs.

Introduction

Operating safety

Proper use of the vehicle

Proper use of the vehicle requires that you are familiar with the following information and rules:

- the safety precautions in this manual
- the "Technical data" section in this manual
- traffic rules and regulations
- motor vehicle laws and safety standards

Warning!



Various warning labels are attached to your vehicle. These warning labels are intended to make you and others aware of various risks. You should not remove any of these warning labels unless explicitly instructed to do so by information on the label itself. Removal of any of these labels may cause you and others to be unaware of certain risks which may result in an accident and/or personal injury.

Introduction

Problems with your vehicle

If you should experience a problem with your vehicle, particularly one that you believe may affect its safe operation, we urge you to immediately contact an authorized Mercedes-Benz Light Truck Center to have the problem diagnosed and corrected if required. If the matter is not handled to your satisfaction, please discuss the problem with the Mercedes-Benz Light Truck Center management, or if necessary contact us at one of the following addresses:

In the USA:

Customer Assistance Center
Mercedes-Benz USA, LLC
One Mercedes Drive
Montvale, NJ 07645-0350

In Canada:

Customer Relations Department
Mercedes-Benz Canada, Inc.
98 Vanderhoof Avenue
Toronto, Ontario, M4G 4C9

▼ **Reporting safety defects**

For the USA only:

The following text is published as required of manufacturers under Title 49, Code of U.S. Federal Regulations, Part 575 pursuant to the “National Traffic and Motor Vehicle Safety Act of 1966”.

Reporting safety defects

If you believe that your vehicle has a defect which could cause a crash or could cause injury or death, you should immediately inform the National Highway Traffic Safety Administration (NHTSA) in addition to notifying Mercedes-Benz USA, LLC.

If NHTSA receives similar complaints, it may open an investigation, and if it finds that a safety defect exists in a group of vehicles, it may order a recall and remedy campaign. However, NHTSA cannot become involved in individual problems between you, your dealer, or Mercedes-Benz USA, LLC.

To contact NHTSA, you may either call the Auto Safety Hotline toll-free at 1-888-327-4236 (or 366-0123 in Washington, D.C. area) or write to: NHTSA, U.S. Department of Transportation, Washington, D.C. 20590. You can also obtain other information about motor vehicle safety from the Hotline.

Introduction

Vehicle data recording

Information regarding electronic recording devices

(Including notice pursuant to California Code § 9951)

Please note that your vehicle is equipped with devices that can record vehicle systems data and, if equipped with the Tele Aid* system, may transmit some data in certain accidents.

This information helps, for example, to diagnose vehicle systems after a collision and to continuously improve vehicle safety. DaimlerChrysler may access the information and share it with others

- for safety research or vehicle diagnosis purposes
- with the consent of the vehicle owner or lessee
- in response to an official request by law enforcement or other government agency
- for use in dispute resolution involving DaimlerChrysler, its affiliates or sales/service organization and/or
- as otherwise required or permitted by law.

Please check the Tele Aid* subscription service agreement for details regarding the information that may be recorded or transmitted via that system.

At a glance

Cockpit

Instrument cluster

Multifunction steering wheel

Center console

Overhead control panel

Door control panel



At a glance

Cockpit



At a glance

Cockpit

Item	Page
① Cruise control lever	238
② Instrument cluster	24
③ Multifunction steering wheel	26
④ Horn	
⑤ Steering wheel gearshift buttons	189
⑥ Gear selector lever for automatic transmission	49
⑦ Front Parktronic* warning indicators	256
⑧ Overhead control panel	29
⑨ Glove box lid release, glove box lock	270

Item	Page
⑩ Glove box	270
⑪ Power outlet	278
⑫ Center console	27
⑬ Starter switch	34
⑭ Steering wheel adjustment, manual	41
⑮ Hood lock release	326
⑯ Parking brake release	52
⑰ Parking brake pedal	52
⑱ Door control panel	30



Item	Page
⑲ Headlamp washer switch*	194
⑳ Exterior lamp switch	54
	138
㉑ Steering wheel adjustment, electrical*	42
㉒ Combination switch	142
• Turn signals	54
• Windshield wipers	55
• High beam	54





At a glance







Instrument cluster



At a glance
Instrument cluster

Item	Page
①  Left turn signal indicator lamp	
② To dim instrument cluster illumination	148
③ Reset button for: Adjusting instrument cluster illumination	148
④ Multifunction display with: Trip odometer Main odometer	150 150
⑤ To brighten instrument cluster illumination	148
⑥  Right turn signal indicator lamp	
⑦ Tachometer with:  Seat belt telltale	388





Item	Page
 Supplemental Restraint System (SRS) indicator lamp	390
 Engine malfunction indicator lamp, USA only	385
 Engine malfunction indicator lamp, Canada only	385
 High beam headlamp indicator	54
⑧ Fuel gauge with: Fuel tank reserve warning lamp	388
⑨ Multifunction display with: Outside temperature display Gear position indicator	150 185





Item	Page
⑩ Clock	
⑪ Speedometer with:  Antilock Brake System (ABS) indicator lamp	382
 Brake warning lamp, USA only	383
 Brake warning lamp, Canada only	383
 ESP [®] warning lamp	387
 Distance warning lamp	
Warning lamp without function. It illuminates when the ignition is on. It should go out when the engine is running.	
 Combination low tire pressure/TPMS malfunction telltale*	391

At a glance

Multifunction steering wheel



Item	Page
① Multifunction display	150
Operating control system	151
② Telephone*: Press button	
 to take a call, or to dial a call	
 to end a call, or to reject an incoming call	
③ Selecting the submenu or setting the volume: Press button	
 up/to increase	
 down/to decrease	

Item	Page
④ Moving within a menu: Press button	
 for next display	
 for previous display	
⑤ Menu systems: Press button	
 for next menu	
 for previous menu	

▼ Center console

Upper part



Item	Page
① Modular COMAND System, see separate operating instructions	
② Climate control	202
3-zone automatic climate control*	216
③ Seat heating*, front passenger-side	133
④ Vehicle level control* switch	252
⑤ Front passenger front air bag off indicator lamp	85
⑥ Storage compartment (depending on equipment configuration for your model)	271

Item	Page
⑦ Electronic Stability Program (ESP) [®] switch	95
⑧ Adaptive damping system (ADS)* switch	249
⑨ Seat heating*, driver's side	133
⑩ Downhill Speed Regulation (DSR) switch	245
⑪ Hazard warning flasher	144
⑫ Switch for Off-road driving program	248

At a glance

Center console

Lower part



	Item	Page
①	Ashtray with cigarette lighter*	275
	Vehicles without ashtray*: Storage compartment with electrical outlet	271
②	Cup holder	274
③	Button for storage tray	272
④	Button for storage compartment (incl. coin holder)	272
⑤	Card, ticket holder	

At a glance

Overhead control panel

▼ Overhead control panel



Item	Page
① Left reading lamp on/off	145
② Cargo compartment lighting on/off	147
③ Automatic interior lighting	145
④ Front interior lighting on/off	146
⑤ Right reading lamp on/off	147
⑥ Front right interior lamp	
⑦ Tilt/sliding sunroof* switch	235
⑧ Tele Aid* (emergency call system) button	280
⑨ Garage door opener	289
⑩ Rear view mirror	194

Item	Page
⑪ Right reading lamp	146
⑫ Vehicles with telephone* installed: Hands-free microphone for Tele Aid* (emergency call system) and telephone*	
⑬ Left reading lamp	
⑭ Vehicles without telephone* installed: Hands-free microphone for Tele Aid* (emergency call system)	
⑮ Front left interior lamp	

At a glance

Door control panel



Item	Page
① Door handle	
② Central unlocking switch	126
Central locking switch	126
③ Exterior rear view mirror adjustment	44
Power folding exterior mirrors, switch for manual activation	197
④ Switches for opening/closing front and rear side windows, rear window override switch	230
⑤ Remote tailgate release switch, Tailgate opening/closing system*	118

Getting started

Unlocking

Adjusting

Driving

Parking and locking



Getting started

Unlocking





The “Getting started” section provides an overview of the vehicle’s most basic functions. First-time Mercedes-Benz owners should pay special attention to the information given here.

If you are already familiar with the basic functions described here, the “Controls in detail” section will provide you with further information. The corresponding page references are located at the end of each segment.

Unlocking with the SmartKey



SmartKey

- ①  Lock button
- ②  Unlock button* for tailgate
- ③  Unlock button
- ④  PANIC (▷ page 91)

Warning!



When leaving the vehicle, always remove the SmartKey from the starter switch, take it with you, and lock the vehicle. Do not leave children unattended in the vehicle, or with access to an unlocked vehicle. Unsupervised use of vehicle equipment may cause an accident and/or serious personal injury.

- ▶ Press unlock button  on the SmartKey.

All turn signal lamps flash once. The vehicle unlocks. The locking knobs in the doors move up. The anti-theft alarm system is disarmed.

- ▶ Get in the vehicle and insert the SmartKey in the starter switch.

For more information, see “Locking and unlocking” (▷ page 106).

Getting started





Unlocking

Unlocking with KEYLESS-GO*

With the KEYLESS-GO function, you can lock or unlock the vehicle without using the remote control buttons on the SmartKey and start the engine without inserting the SmartKey in the starter switch.



SmartKey with KEYLESS-GO*

- ①  Lock button
- ②  Unlock button* for tailgate
- ③  Unlock button
- ④  PANIC button (▷ page 91)



To unlock the vehicle, the SmartKey with KEYLESS-GO must be outside the vehicle, no further than approximately 3 feet (1 meter) away from the respective door.

Warning!



When leaving the vehicle, always take the SmartKey with KEYLESS-GO* with you, and lock the vehicle. Do not leave children unattended in the vehicle, or with access to an unlocked vehicle. Unsupervised use of vehicle equipment may cause an accident and/or serious personal injury.

- ▶ Grasp an outside door handle.

All turn signal lamps flash once. The vehicle unlocks. The locking knobs in the doors move up. The anti-theft alarm system is disarmed.



If the vehicle has been parked for more than 72 hours, you must pull an outside door handle in order to activate the KEYLESS-GO function.

- ▶ Get in the vehicle.

For more information, see “SmartKey with KEYLESS-GO*” (▷ page 110).

Getting started

Unlocking

Starter switch positions

Warning!



When leaving the vehicle, always remove the SmartKey or SmartKey with KEYLESS-GO* from the starter switch, take it with you and lock the vehicle. Do not leave children unattended in the vehicle, or with access to an unlocked vehicle. Unsupervised use of vehicle equipment may cause an accident and/or serious personal injury.

SmartKey



Starter switch

- 0** For removing SmartKey
- 1** Power supply for some electrical consumers, such as seat adjustment
- 2** Ignition (power supply for all electrical consumers) and driving position
All lamps (except high beam headlamp indicator lamp and turn signal indicator lamps unless activated) in the instrument cluster come on. If a lamp in the instrument cluster fails to come on when the ignition is switched on, have it checked and replaced if necessary. If a lamp in the instrument cluster re-

mains on after starting the engine or comes on while driving, refer to “Lamps in instrument cluster” (▷ page 382).

3 Starting position



When you switch on the ignition, the indicator and warning lamps (except high beam headlamp indicator lamp and turn signal indicator lamps unless activated) in the instrument cluster come on. The indicator and warning lamps (except high beam headlamp indicator lamp and turn signal indicator lamps if activated) will go out when the engine is running. This indicates that the respective systems are operational.



When the SmartKey is removed from the starter switch and the automatic transmission is in a position other than **P**, the transmission automatically shifts to **P**.

Getting started

Unlocking



If the SmartKey cannot be turned in the starter switch, the battery may not be sufficiently charged.

- Check the battery and charge it if necessary (▷ page 440).
- Get a jump start (▷ page 470).

To prevent accelerated battery discharge or a completely discharged battery, always remove the SmartKey from the starter switch when the engine is not in operation.

SmartKey with KEYLESS-GO*

Vehicles equipped with the KEYLESS-GO feature are supplied with a SmartKey with integrated KEYLESS-GO function and a removable KEYLESS-GO start/stop button.

With the KEYLESS-GO start/stop button inserted and the SmartKey with KEYLESS-GO present in the vehicle, pressing the KEYLESS-GO start/stop button

- without the brake pedal depressed corresponds to the various starter switch positions (▷ page 36)
- with the brake pedal firmly depressed will start the engine (▷ page 49)

If you wish or should there be a need to insert the SmartKey with KEYLESS-GO in the starter switch, the start/stop button can be easily removed by pulling it out of the starter switch.



If you firmly depress the brake pedal while pressing the KEYLESS-GO start/stop button, the engine starts automatically.



The KEYLESS-GO start/stop button does not need to be removed from the starter switch when you leave the vehicle. However, always take the SmartKey with KEYLESS-GO with you when you leave the vehicle. As long as the SmartKey with KEYLESS-GO is in your vehicle, the vehicle's electrical systems can be switched on or the engine can be started using the KEYLESS-GO start/stop button.

Warning!



When leaving the vehicle, always take the SmartKey with KEYLESS-GO with you and lock the vehicle. Do not leave children unattended in the vehicle, or with access to an unlocked vehicle. Unsupervised use of vehicle equipment may cause an accident and/or serious personal injury.

Getting started

Unlocking

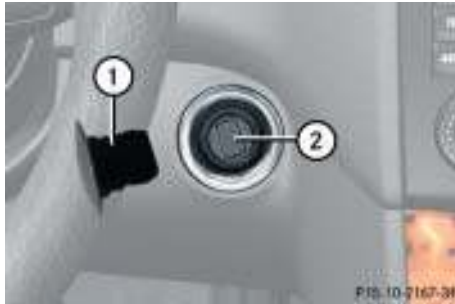

- ① KEYLESS-GO start/stop button
- ② Starter switch



KEYLESS-GO start/stop button

- ① USA only
- ② Canada only

The SmartKey with KEYLESS-GO must be located in the vehicle.

- ▶ Make sure the automatic transmission is set to **P**.
- ▶ Do not depress the brake pedal.

Position 0

Before you press the KEYLESS-GO start/stop button, the vehicle's on-board electronics have status **0** (as with SmartKey removed).

Position 1

- ▶ Press the KEYLESS-GO start/stop button once.

This supplies power for some electrical consumers, such as seat adjustment.



If you now press the KEYLESS-GO start/stop button

- once more, the ignition (position **2**) is switched on
- twice more, the power supply is again switched off

Ignition (or Position 2)

- ▶ Press the KEYLESS-GO start/stop button twice.

All lamps in the instrument cluster come on. If a lamp in the instrument cluster fails to come on when the ignition is switched on, have it checked and replaced if necessary. If a lamp in the instrument cluster remains on after starting the engine or comes on while driving, refer to "Lamps in instrument cluster" (▷ page 382).



If you now press the KEYLESS-GO start/stop button once more, the power supply is again switched off.



When you switch on the ignition, the indicator and warning lamps (except high beam headlamp indicator lamp and turn signal indicator lamps unless activated) in the instrument cluster come on. The indicator and warning lamps (except high beam headlamp indicator lamp and turn signal indicator lamps if activated) should go out when the engine is running. This indicates that the respective systems are operational.

For information on starting the engine using the KEYLESS-GO start/stop button, see “Starting with KEYLESS-GO*” (▷ page 50).

Getting started

Adjusting

Warning!



All seat, head restraint, steering wheel, and rear view mirror adjustments, as well as fastening of seat belts, must be done before the vehicle is put into motion.

Seats

Warning!



Do not adjust the driver's seat while driving. Adjusting the seat while driving could cause the driver to lose control of the vehicle.

Never ride in a moving vehicle with the seat back in an excessively reclined position as this can be dangerous. You could slide under the seat belt in a collision. If you slide under it, the belt would apply force at the abdomen or neck. That could cause serious or fatal injuries. The seat backrest and seat belts provide the best restraint when the wearer is in a nearly upright position and belts are properly positioned on the body.

Your seat must be adjusted so that you can correctly fasten your seat belt (▷ page 39).

Never place hands under the seat or near any moving parts while a seat is being adjusted.

Warning!



When leaving the vehicle, always remove the SmartKey or SmartKey with KEYLESS-GO* from the starter switch, take it with you, and lock the vehicle.

Even with the SmartKey or the SmartKey with KEYLESS-GO* removed from the starter switch or the SmartKey with KEYLESS-GO* removed from the vehicle, the power seats can be operated when the respective door is open.

Therefore, do not leave children unattended in the vehicle, or with access to an unlocked vehicle. Unsupervised use of vehicle equipment may cause an accident and/or serious personal injury.

Warning!



According to accident statistics, children are safer when properly restrained in the rear seating positions than in the front seating position. Thus, we strongly recommend that children be placed in the rear seats whenever possible. Regardless of seating position, children 12 years old and under must be seated and properly secured in an appropriate infant, or toddler restraint, or booster seat recommended for the size and weight of the child. For additional information, see "Children in the vehicle" (▷ page 78).

A child's risk of serious or fatal injuries is significantly increased if the child restraints are not properly secured in the vehicle and/or the child is not properly secured in the child restraint.

Seat adjustment

The seat adjustment switch is located on the entry side of each front seat base.



- ① Head restraint height*
- ② Seat cushion tilt
- ③ Seat height
- ④ Backrest tilt
- ⑤ Seat fore and aft adjustment

- ▶ Switch on the ignition (▷ page 34).
or
- ▶ Open the respective door.



When moving the seat, make sure there are no items in the footwell or behind the seat. Otherwise you could damage the seat.

When the rear bench seat is folded forward, the front seats cannot be moved to the rearmost position. Otherwise you could damage the front seats and the rear bench seat.



When adjusting the backrest tilt and head restraint height, make sure that the sun visor is folded up. If the head restraint is in the uppermost position, it could hit and damage the sun visor.

Seat fore and aft adjustment

- ▶ Press the switch forward or backward in the direction of arrow ⑤.

Adjust seat to a comfortable seating position that still allows you to reach the accelerator/brake pedal safely. The position should be as far to the rear as possible, consistent with ability to properly operate controls.



The memory function* (▷ page 135) lets you store the setting for the seat positions together with the setting for the steering wheel and the exterior rear view mirrors.

Seat height

- ▶ Press the switch up or down in the direction of arrow ③.

Getting started

Adjusting

Seat cushion tilt

- ▶ Press the switch up or down in the direction of arrow ② until your upper legs are lightly supported.

Seat backrest tilt

- ▶ Press the switch forward or backward in the direction of arrow ④ until your arms are slightly angled when holding the steering wheel.

Head restraint height

Warning!



For your protection, drive only with properly positioned head restraints.

Adjust head restraint so that the center of the head restraint supports the back of the head at eye level. This will reduce the potential for injury to the head and neck in the event of an accident or similar situation.

Do not drive the vehicle without the seat head restraints. Head restraints are intended to help reduce injuries during an accident.



Adjust the head restraint in such a way that it is as close to the head as possible.

Vehicles with memory function*:

- ▶ Press switch ① (▷ page 39) up or down in the direction of arrow.

Vehicles without memory function*:



① Release button

Raising:

- ▶ Manually adjust the height of the head restraint by pulling it upward.

If the head restraint is fully retracted, push release button ① in direction of arrow and pull the head restraint up.

Lowering:

- ▶ To lower the head restraint, push release button ① in direction of arrow and press down on the head restraint.

Head restraint tilt



Manually adjust the angle of the head restraint.

- ▶ Push or pull on the lower edge of the head restraint cushion.



Adjust the head restraint in such a way that it is as close to the head as possible.

For more information, see “Seats” (▷ page 128).

Getting started

Adjusting

Steering wheel

Steering wheel adjustment, manual

Warning!



Only adjust the steering wheel with the vehicle at a standstill and make sure the steering wheel is securely locked in place before driving off.

Driving without the steering wheel adjustment locked may cause an unexpected steering wheel movement which could cause the driver to lose control of the vehicle. Make sure the steering wheel is securely locked by trying to move it up and down, and in and out before driving off.

Getting started

Adjusting

The adjustment handle for manual steering wheel adjustment is located under the steering column.



- ▶ To unlock the steering column, pull handle out to its stop limit.
- ▶ Move steering wheel to the desired position.

Make sure your legs can move freely and that all the displays (including malfunction and indicator lamps) on the instrument cluster are clearly visible.

- ▶ Push handle back to its original position to relock the steering column.

The steering column is once again locked into position.

- ▶ Make sure the steering column is securely locked by trying to move the steering wheel up and down, in and out before driving off.



Do not drive the vehicle until you have properly locked the steering column.

Steering wheel adjustment, electrical*

Warning!



Do not adjust the steering wheel while driving. Adjusting the steering wheel while driving could cause the driver to lose control of the vehicle.

When leaving the vehicle, always remove the SmartKey or SmartKey with KEYLESS-GO* from the starter switch, take it with you, and lock the vehicle.

Even with the SmartKey or SmartKey with KEYLESS-GO* removed from the starter switch or the SmartKey with KEYLESS-GO* removed from the vehicle, the steering wheel adjustment feature can be operated when the driver's door is open. Therefore, do not leave children unattended in the vehicle, or with access to an unlocked vehicle. Unsupervised use of vehicle equipment may cause an accident and/or serious personal injury.

The stalk for steering wheel adjustment is located on the steering column (lower left).



- ① Adjusting steering column, in or out
- ② Adjusting steering column, up or down

► Switch on the ignition (▷ page 34).

or

► Open the driver's door.

Adjusting steering column in or out

- Move stalk forward or back in the direction of arrow ① until a comfortable steering wheel position is reached with your arms slightly bent at the elbow.

Adjusting steering column up or down

- Move stalk up or down in the direction of arrow ②.

Make sure your legs can move freely and that all the displays (including malfunction and indicator lamps) on the instrument cluster are clearly visible.



The memory function* (▷ page 135) lets you store the setting for the seat position together with the setting for the steering wheel and the exterior rear view mirrors.

Getting started

Adjusting

Mirrors

Adjust the interior and exterior rear view mirrors before driving so that you have a good view of the road and traffic conditions.

Warning!



In case of an accident, liquid electrolyte may escape the mirror housing if the mirror glass breaks.

Electrolyte has an irritating effect. Do not allow the liquid to come into contact with eyes, skin, clothing, or respiratory system. In case it does, immediately flush affected area with water, and seek medical help if necessary.



Electrolyte drops coming into contact with the vehicle paint finish can only be completely removed while in their liquid state and by applying plenty of water.

Getting started

Adjusting

Interior rear view mirror

- ▶ Manually adjust the interior rear view mirror.

For more information, see “Rear view mirrors” (▷ page 194).

Exterior rear view mirrors

Warning!



Exercise care when using the passenger-side exterior rear view mirror. The mirror surface is convex (outwardly curved surface for a wider field of view). Objects in mirror are closer than they appear. Check your interior rear view mirror or glance over your shoulder before changing lanes.

The buttons are located on the driver's door.



- ① Driver's side exterior rear view mirror button
- ② Adjustment button
- ③ Passenger-side exterior rear view mirror button

- ▶ Switch on the ignition (▷ page 34).
- ▶ Press button ① for the driver's side exterior rear view mirror or button ③ for the passenger-side exterior rear view mirror.

The indicator lamp on the respective button comes on for approximately 15 seconds.



If you do not make adjustments to the selected exterior rear view mirror within 15 seconds, the indicator lamp goes out. You then will have to select the desired exterior rear view mirror again before any adjustments can be made. Adjustments can only be made with the indicator lamp for the respective exterior rear view mirror button illuminated.

- ▶ Push adjustment button ② up, down, left, or right according to the desired setting.



The memory function* (▷ page 135) lets you store the setting for the seat position together with the setting for the steering wheel and the exterior rear view mirrors.

At low ambient temperatures, the mirrors will be heated automatically.



Vehicle without power folding exterior rear view mirrors*:

If an exterior rear view mirror was forcibly pushed forward (hit from the rear) or forcibly pushed rearward (hit from the front), reposition it by applying firm pressure until it snaps into place. The mirror housing is now properly positioned and you can adjust the mirror normally.

For vehicle with power folding exterior rear view mirrors, see “Power folding exterior rear view mirrors*” (▷ page 197).

For more information, see “Rear view mirrors” (▷ page 194).

Getting started

Driving

Warning!



Do not lay any objects in the driver's footwell. Be careful that floor mats or carpets in the driver's footwell have sufficient clearance for the pedals.

During sudden driving or braking maneuvers, the objects could get caught between the pedals. You could then no longer brake or accelerate.

Fastening the seat belts

Warning!



Always fasten your seat belt before driving off. Always make sure your passengers are properly restrained, even those sitting in the rear and pregnant women.

Failure to wear and properly fasten and position your seat belt greatly increases your risk of injuries and their likely severity in an accident. You and your passengers should always wear seat belts.

If you are ever in an accident, your injuries can be considerably more severe without your seat belt properly buckled. Without your seat belt buckled, you are much more likely to hit the interior of the vehicle or be ejected from it. You can be seriously injured or killed.

In the same crash, the possibility of injury or death is lessened if you are wearing your seat belt. The air bags can only provide the protection they were designed to afford if the occupants are using their seat belts (▷ page 66).

Warning!



According to accident statistics, children are safer when properly restrained in the rear seating positions than in the front seating position. Thus, we strongly recommend that children be placed in the rear seats. Regardless of seating position, children 12 years old and under must be seated and properly secured in an appropriate infant, or toddler restraint, or booster seat recommended for the size and weight of the child. For additional information, see "Children in the vehicle" (▷ page 78).

A child's risk of serious or fatal injuries is significantly increased if the child restraints are not properly secured in the vehicle and/or the child is not properly secured in the child restraint.

Getting started

Driving

Warning!



Never let more people ride in the vehicle than there are seat belts available. Make sure everyone riding in the vehicle is correctly restrained with a separate seat belt. Never use a seat belt for more than one person at a time.

Warning!



Read and observe the additional warning notices printed in the “Safety and Security” section (> page 70) and (> page 73).

Warning!



Never ride in a moving vehicle with the seat backrest in an excessively reclined position as this can be dangerous. You could slide under the seat belt in a collision. If you slide under it, the belt would apply force at the abdomen or neck. That could cause serious or even fatal injuries. The seat backrest and seat belt provide the best restraint when the wearer is in a nearly upright position and the belt is properly positioned on the body.



- ① Latch plate
- ② Buckle
- ③ Release button

Getting started

Driving

- ▶ With a smooth motion, pull the belt from the belt outlet.
- ▶ Place the shoulder portion of the belt across the top of your shoulder and the lap portion across your hips.
- ▶ Push latch plate ① into buckle ② until it clicks (▷ page 47).
- ▶ If necessary, tighten the lap portion to a snug fit by pulling shoulder portion up.

Seat belt height adjustment



① Release button

- ▶ Press release button ① and move the seat belt height adjuster upward or downward.

Proper use of seat belts

- Do not twist the belt when fastening.
 - Adjust seat belt so that the shoulder portion is located as close as possible to the middle of the shoulder (it should not touch the neck). Never pass the shoulder portion of the belt under your arm. For this purpose, you can adjust the height of the belt outlet (▷ page 48).
 - Position the lap belt as low as possible on your hips (over hip joint) and not across the abdomen.
 - Place the seat backrest in a nearly upright position.
- Never use a seat belt for more than one person at a time.
 - Do not fasten a seat belt around a person and another object at the same time. When using a seat belt to secure infant or toddler restraints or children in booster seats, always follow the child seat manufacturer's instructions.
 - Check your seat belt periodically during travel to make sure that it is properly positioned.
 - Make sure that the seat belt is always fitted snugly. Take special care of this when wearing loose clothing.

Warning!



Do not pass belts over sharp edges. They could tear.

Do not allow the belt to get caught in the door or in the seat adjustment mechanism. This could damage the belt.

Never attempt to make modifications to seat belts. This could impair the effectiveness of the belts.

Do not bleach or dye seat belts as this may severely weaken them. In a crash, they may not be able to provide adequate protection.

Damaged seat belts or belts that were highly stressed in an accident must be replaced. Contact an authorized Mercedes-Benz Light Truck Center.

Starting the engine

Warning!



Inhalation of exhaust gas is hazardous to your health. All exhaust gas contains carbon monoxide, and inhaling it can cause unconsciousness and lead to death.

Do not run the engine in confined areas (such as a garage) which are not properly ventilated. If you think that exhaust gas fumes are entering the vehicle while driving, have the cause determined and corrected immediately. If you must drive under these conditions, drive only with at least one window fully open.

Automatic transmission



Gearshift pattern for automatic transmission

- P** Park position
- R** Reverse gear
- N** Neutral
- D** Drive position

For more information on how to operate the gear selector lever, see “Automatic transmission” (▷ page 182).

Getting started

Driving

Starting with the SmartKey

- ▶ Make sure the automatic transmission is set to **P**.

The transmission gear position **P** appears in the multifunction display.

- ▶ Do not depress accelerator.
- ▶ Turn the SmartKey in the starter switch to position **3** (▷ page 34) and hold until the engine starts.



You can also use the “touch-start” function. Turn the SmartKey to position **3** and release it again immediately. The engine then starts automatically.

For information on turning off the engine with the SmartKey, see “Turning off engine” (▷ page 62).

Starting with KEYLESS-GO*

Warning!



As long as the SmartKey with KEYLESS-GO is in your vehicle, the vehicle can be started. Therefore, never leave children unattended in the vehicle, as they could otherwise accidentally start the engine.

When leaving the vehicle, always take the SmartKey with KEYLESS-GO with you and lock the vehicle. Do not leave children unattended in the vehicle, or with access to an unlocked vehicle.

You can start your vehicle without the SmartKey in the starter switch using the KEYLESS-GO start/stop button in the starter switch.

The SmartKey with KEYLESS-GO must be located in the vehicle.

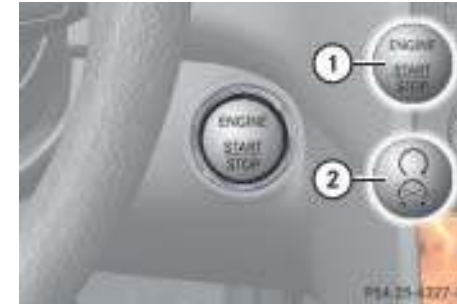

KEYLESS-GO start/stop button

- ① USA only
- ② Canada only

- ▶ Make sure the KEYLESS-GO start/stop button ① is inserted in the starter switch (▷ page 35).
- ▶ Make sure the automatic transmission is set to **P**.
- ▶ Depress the brake pedal during the starting procedure. Do not depress accelerator.

- ▶ Press KEYLESS-GO start/stop button ① once.

The engine starts if the SmartKey with KEYLESS-GO is in the vehicle.



If you wish to start the engine using the SmartKey instead of the KEYLESS-GO feature, remove the KEYLESS-GO* start/stop button from starter switch (▷ page 35).

For information on turning off the engine with KEYLESS-GO, see “Turning off with KEYLESS-GO*” (▷ page 63).

Starting difficulties

If the engine does not start as described, carry out the following steps:

- ▶ If you are starting the engine with the SmartKey, turn SmartKey in starter switch to position **0** and repeat starting procedure.
 - ▶ If you are starting the engine with KEYLESS-GO*: Close any doors that may be open to allow for better detection of the SmartKey with KEYLESS-GO*.
- Or:
- ▶ Remove KEYLESS-GO* start/stop button from starter switch.
 - ▶ Start the engine with the SmartKey as radio signals from another source may be interfering with the SmartKey with KEYLESS-GO*.

- ▶ Repeat the starting procedure (▷ page 49). Remember that extended starting attempts can drain the battery.
- ▶ Get a jump start (▷ page 470).

If the engine does not start after several starting attempts, there could be a malfunction in the engine electronics or in the fuel supply system.

- ▶ Notify an authorized Mercedes-Benz Light Truck Center.

Getting started

Driving

Parking brake

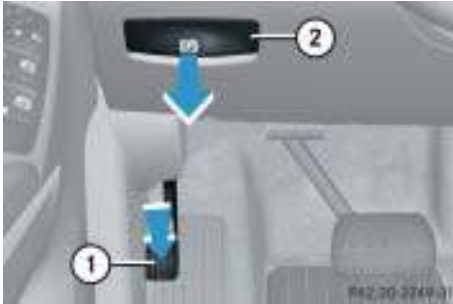

- ① Parking brake pedal
- ② Release handle

Warning!



When leaving the vehicle, always remove the SmartKey or SmartKey with KEYLESS-GO* from the starter switch, take it with you and lock the vehicle. Do not leave children unattended in the vehicle, or with access to an unlocked vehicle. Children could release the parking brake, which could result in an accident and/or serious injury.

- ▶ Release the parking brake pedal ① by pulling on release handle ②.

The warning lamp **BRAKE** (USA only) or **(P)** (Canada only) in the instrument cluster goes out.

Driving

- ▶ Depress the brake pedal.
The gear selector lever can now be used.
- ▶ Shift automatic transmission to **D** or **R** (> page 182).



Wait for the gear selection process to complete before setting the vehicle in motion.



Shifting from gear position **P** to position **R**, **N**, or **D** is only possible with the brake pedal depressed. Without the brake pedal depressed, the gear selector lever can be moved, but the parking pawl remains engaged, not allowing shifting to occur.

- ▶ Release the brake pedal.
- ▶ Carefully depress the accelerator pedal.

Once the vehicle is in motion, the automatic central locking system engages and the locking knobs drop down.



The automatic door lock feature can be deactivated (> page 172).



You can open a locked door from the inside. Open door only when conditions are safe to do so.



If you hear a warning signal and the message *Release parking brake* appears in the multifunction display when driving off, you have forgotten to release the parking brake.

Release the parking brake.

After a cold start, the automatic transmission shifts at a higher engine revolution. This allows the catalytic converter to reach its operating temperature earlier.

Warning!



On slippery road surfaces, never downshift in order to obtain braking action. This could result in drive wheel slip and reduced vehicle control. Your vehicle's ABS will not prevent this type of loss of control.

Warning!



It is dangerous to shift the automatic transmission out of **P** or **N** if the engine speed is higher than idle speed. If your foot is not firmly on the brake pedal, the vehicle could accelerate quickly forward or in reverse. You could lose control of the vehicle and hit someone or something. Only shift into gear when the engine is idling normally and when your right foot is firmly on the brake pedal.



Shift automatic transmission to position **P** or **R** only when the vehicle is stopped in order to avoid damaging the transmission.



Do not run cold engine at high engine speeds. Running a cold engine at high engine speeds may shorten the service life of the engine.



Simultaneously depressing the accelerator pedal and applying the brake reduces engine performance and causes premature brake and drivetrain wear.

For more information, see “Driving instructions” (▷ page 299).

For information on off-road driving, see “Off-road driving” (▷ page 306).

Getting started

Driving

Switching on headlamps

For more information on headlamps, see “Lighting” (> page 138).

Low beam headlamps

The exterior lamp switch is located on the dashboard to the left of the steering wheel.



Exterior lamp switch

- ① Off
- ② Low beam headlamps on
- ▶ Turn exterior lamp switch to .

High beam

The combination switch is located on the left of the steering column.



Combination switch

- ① High beam
- ② High beam flasher

- ▶ Push the combination switch in direction of arrow ①.

The high beam headlamp indicator lamp  in the instrument cluster comes on (> page 25).

For more information on headlamps, see “Combination switch” (> page 142).

Turn signals



The combination switch is on the left of the steering column.



Combination switch

- ① Turn signals, right
- ② Turn signals, left

- ▶ Press combination switch in direction of arrow ① or ②.

The corresponding turn signal indicator lamp  or  in the instrument cluster flashes.

The combination switch resets automatically after major steering wheel movements.



To signal minor directional changes, move combination switch to point of resistance and release. The turn signal flashes three times.

Windshield wipers

The combination switch is located on the left of the steering column.



Combination switch

- ① Single wipe
Wiping with windshield washer fluid
 - ② Switching on windshield wipers
- Switch on the ignition (► page 34).

Getting started

Driving

Switching on windshield wipers

- Turn the combination switch to the desired position depending on the intensity of the rain.
 - 0 Windshield wipers off
 - I Intermittent wiping
 - II Normal wiper speed
 - III Fast wiper speed



Vehicles with rain sensor*: Intermittent wiping interval is dependent on wetness of windshield. Pauses between wipes are automatically controlled by the rain sensor.

Getting started

Driving



Vehicles with rain sensor*:
Do not leave windshield wipers in intermittent setting when the vehicle is taken to an automatic car wash or during windshield cleaning. Wipers will operate in the presence of water sprayed on the windshield, and wipers may be damaged as a result.

Do not operate the wipers when the windshield is dry. Dust that accumulates on a windshield might scratch the glass and/or damage the wiper blades when wiping occurs on a dry windshield. If it is necessary to operate the wipers in dry weather conditions, always operate the wipers with windshield washer fluid (▷ page 56).

Intermittent wiping

- ▶ Set the wiper switch to position I.



Intermittent wiping is interrupted when the vehicle is at a standstill and a front door is opened.

Single wipe

- ▶ Press switch briefly in the direction of arrow ①.

The windshield wipers wipe one time without washer fluid.

Wiping with windshield washer fluid

- ▶ Push switch in the direction of arrow ① past the resistance point.

The windshield wipers operate with washer fluid.

For information on filling up the washer reservoir, see “Windshield/rear window washer system and headlamp cleaning system*” (▷ page 333).



If anything blocks the windshield wipers (leaves, snow, etc.), switch them off immediately.

For safety reasons, stop the vehicle in a safe location and

- turn off the engine by turning the SmartKey to position **0** and withdraw SmartKey from starter switch

or

- turn off the engine by pressing the KEYLESS-GO* start/stop button and open the driver's door (with the driver's door open, starter switch is in position **0**, same as with SmartKey removed from starter switch)

before attempting to remove any blockage.

- Remove blockage.
- Turn the windshield wipers on again.

If windshield wipers fail to function at all in switch position **I**,

- set the combination switch to the next highest wiper speed
- have the windshield wipers checked at the nearest authorized Mercedes-Benz Light Truck Center

Getting started

Driving

Rear window wiper/washer

The combination switch is located on the left of the steering column.

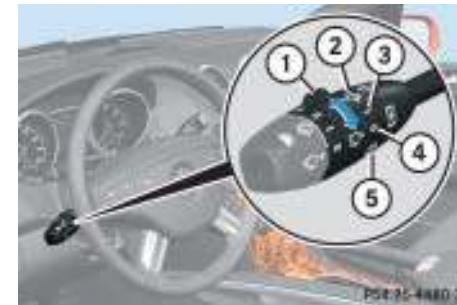

Combination switch

- ① Rear window wiper switch
- ② Wiping rear window with washer fluid
- ③ Intermittent wiper
- ④ Rear window wiper off
- ⑤ Wiping rear window with washer fluid >>

Getting started

Driving



⑥ Symbol in multifunction display indicating that rear window wiper is activated

- ▶ Switch on the ignition (▷ page 34).



The rear window wiper engages automatically if the automatic transmission is shifted to position **R** with the windshield wipers switched on.

Activating intermittent wiping

- ▶ Turn switch ① to position ③.

Deactivating intermittent wiping

- ▶ Turn switch ① to position ④.

Wiping with windshield washer fluid

- ▶ Turn switch ① to position ② or ⑤.

The rear window wiper operates with washer fluid.

Hold switch ① in position ② or ⑤ until the rear window is clean.

For information on filling up the washer reservoir, see “Windshield/rear window washer system and headlamp cleaning system*” (▷ page 333).

Problems while driving

The engine runs erratically and misfires

- An ignition cable may be damaged.
- The engine electronics may not be operating properly.
- Unburned gasoline may have entered the catalytic converter and damaged it.
- ▶ Give very little gas.
- ▶ Have the problem repaired by an authorized Mercedes-Benz Light Truck Center as soon as possible.

The coolant temperature is above 248°F (120°C)

The coolant is too hot and is no longer cooling the engine.

- ▶ Stop the vehicle as soon as possible and turn off the engine. Allow engine and coolant to cool.
- ▶ Check the coolant level and add coolant if necessary (▶ page 332).

In case of accident

If the vehicle is leaking fuel:

- ▶ Do not start the engine under any circumstances.
- ▶ Notify local fire and/or police authorities.

If the extent of the damage cannot be determined:

- ▶ Notify an authorized Mercedes-Benz Light Truck Center.

If no damage can be determined on the

- major assemblies
 - fuel system
 - engine mount:
- ▶ Start the engine in the usual manner.

Getting started

Parking and locking

You have now completed your first drive. You have properly stopped and parked your vehicle. End your drive as follows.

Warning!



With the engine not running, there is no power assistance for the brake and the steering system. In this case, it is important to keep in mind that a considerably higher degree of effort is necessary to brake and steer the vehicle.

Warning!



Do not park this vehicle in areas where combustible materials such as grass, hay or leaves can come into contact with the hot exhaust system, as these materials could be ignited and cause a vehicle fire.

To reduce the risk of personal injury as a result of vehicle movement, before turning off the engine and leaving the vehicle always:

- Keep right foot on brake pedal.
- Firmly depress parking brake pedal.
- Shift the automatic transmission to position **P**.
- Slowly release brake pedal.
- When parked on an incline, turn front wheel towards the road curb.

- Turn the SmartKey to starter switch position **0** and remove, or press start/stop button (vehicles with KEYLESS-GO*).
- Take the SmartKey or the SmartKey with KEYLESS-GO* and lock vehicle when leaving.

Getting started

Parking and locking

Parking brake

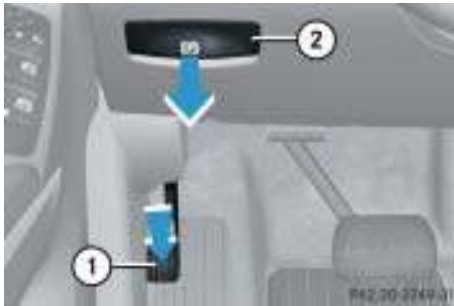

- ① Parking brake pedal
- ② Release handle

- ▶ Step firmly on parking brake pedal ①.

When the engine is running, the indicator lamp **BRAKE** (USA only) or  (Canada only) in the instrument cluster comes on.

Warning!



When leaving the vehicle, always remove the SmartKey or SmartKey with KEYLESS-GO* from the starter switch, take it with you and lock the vehicle. Do not leave children unattended in the vehicle, or with access to an unlocked vehicle. Children could release the parking brake and/or shift the automatic transmission out of position **P**, either of which could result in an accident and/or serious personal injury.

Warning!



Getting out of your vehicle with the automatic transmission not fully engaged in position **P** is dangerous. Also, when parked on an incline, position **P** alone may not prevent your vehicle from moving, possibly hitting people or objects.

Always set the parking brake in addition to shifting to position **P** (▷ page 185).

When parked on an incline, also turn front wheel towards the road curb.

Getting started

Parking and locking

Switching off headlamps

- ▶ Turn the exterior lamp switch to **0**.
For more information, see “Lighting” (▷ page 138).

Turning off engine

- ▶ Shift automatic transmission to position **P**.



Always set the parking brake in addition to shifting to position **P**.

On slopes, turn the front wheels towards the road curb.

Turning off with the SmartKey

- ▶ Turn the SmartKey in the starter switch to position **0** (▷ page 34) and remove it.
The immobilizer is activated.



If you turn off the engine using the SmartKey and remove the SmartKey from the starter switch with the transmission in a position other than **P**, the transmission will automatically shift to **P**.

Keep in mind that turning off the engine with the SmartKey alone will not automatically shift the transmission to **P**. Only when the SmartKey is removed from the starter switch will the transmission automatically shift to **P**.

- ▶ Press the seat belt release button (▷ page 47).

Allow the retractor to completely re-wind the seat belt by guiding the latch plate.



With the SmartKey removed and the driver's door open, a warning sounds and the message *Switch off lights* appears in the multifunction display if the vehicle's exterior lamps are not switched off.

Warning!



To prevent possible personal injury, always keep hands and fingers away from the door openings when closing the doors. Be especially careful when small children are around.

Before closing doors, make sure there is no possibility of someone getting caught in a door during closing.

- ▶ After exiting the vehicle, press the lock button  on the SmartKey (▷ page 32).

The turn signal lamps flash three times. The locking knobs on the doors move down. The anti-theft alarm system is armed.

Warning!



When leaving the vehicle, always remove the SmartKey or SmartKey with KEYLESS-GO* from the starter switch, take it with you, and lock the vehicle. Do not leave children unattended in the vehicle, or with access to an unlocked vehicle. Unsupervised use of vehicle equipment may cause an accident and/or serious personal injury.

For more information, see “Locking and unlocking” (▷ page 106).

Turning off with KEYLESS-GO*

- ▶ Shift automatic transmission to position **P**.
- ▶ Press the KEYLESS-GO start/stop button to shut off the engine.

With the driver’s door closed, the starter switch is now in position **1**. With the driver’s door opened, the starter switch is set to position **0**, same as SmartKey removed from starter switch (▷ page 34).

Getting started
Parking and locking



If you turn off the engine using the KEYLESS-GO start/stop button and open the driver’s door with the transmission in a position other than **P**, the transmission will automatically shift to **P**.

Keep in mind that turning off the engine with the KEYLESS-GO start/stop button alone will not automatically shift the transmission to **P**. Only when the driver’s door is opened will the transmission automatically shift to **P**.

- ▶ Press the seat belt release button.
Allow the retractor to completely rewind the seat belt by guiding the latch plate.



Getting started

Parking and locking



If you hear a warning signal, you have forgotten to turn off the lights.

Turn off the lights.

Warning!



To prevent possible personal injury, always keep hands and fingers away from the door openings when closing the doors. Be especially careful when small children are around.

Before closing doors, make sure there is no possibility of someone getting caught in a door during closing.



① Lock button

- ▶ After exiting the vehicle, press lock button ① at the outside door handle or on the tailgate (▷ page 121).

All turn signal lamps flash three times. The locking knobs on the doors move down. The anti-theft alarm system is armed.

Warning!



When leaving the vehicle, always remove the SmartKey from the starter switch, take the SmartKey with KEYLESS-GO* with you, and lock your vehicle. Do not leave children unattended in the vehicle, or with access to an unlocked vehicle. Unsupervised use of vehicle equipment may cause an accident and/or serious personal injury.

For more information, see “Locking and unlocking” (▷ page 106).

Safety and Security

Occupant safety

Panic alarm

Driving safety systems

Anti-theft systems



Safety and Security

Occupant safety

In this section you will learn the most important facts about the restraint systems of the vehicle.

- Seat belts (▷ page 73)
- Child restraints (▷ page 87)
- Lower anchors and tethers for children (LATCH) (▷ page 88)

Supplemental Restraint System (SRS) with

- Air bags (▷ page 67)
- Air bag control unit (with crash sensors)
- Emergency tensioning device (ETD) for seat belts (▷ page 76)

Air bag system components with

- Front passenger front air bag off indicator lamp (▷ page 85)
- Front passenger seat with Occupant Classification System (OCS) (▷ page 81)

As independent systems, their protective functions work in conjunction with each other.



For information on infants and children traveling with you in the vehicle and restraint systems for infants and children, see “Children in the vehicle” (▷ page 78).

The SRS system conducts a self-test when the ignition is switched on and in regular intervals while the engine is running. This facilitates early detection of malfunctions. The **SRS** indicator lamp in the instrument cluster (▷ page 25) comes on when the ignition is switched on and goes out no later than a few seconds after the engine has been started.

The SRS components are in operational readiness if the **SRS** indicator lamp is not lit when the engine is running.

A malfunction in the system has been detected if the **SRS** indicator lamp:

- fails to go out not later than approximately four seconds after the engine was started
- does not come on at all
- comes on after the engine was started or while driving

Warning!



In the event that the **SRS** indicator lamp comes on during driving or does not come on at all, the SRS self-check has detected a malfunction. For your safety, we strongly recommend that you visit an authorized Mercedes-Benz Light Truck Center immediately to have the system checked; otherwise the SRS may not deploy when needed in an accident, which could result in serious or fatal injury, or it might deploy unexpectedly and unnecessarily which could also result in injury.

In addition, improper work on the SRS creates a risk of rendering the SRS inoperative or causing unintended air bag deployment. Work on the SRS must therefore only be performed by qualified technicians. Contact an authorized Mercedes-Benz Light Truck Center.

If it is necessary to modify an air bag system to accommodate a person with disabilities, contact your local authorized Mercedes-Benz Light Truck Center or call our Customer Assistance Center at 1-800-FOR-MERCEdes (1-800-367-6372) for details.

Safety and Security

Occupant safety

Air bags

Warning!



Air bags are designed to reduce the potential of injury and fatality in certain frontal impacts (front air bags), side impacts (side impact air bags and head protection window curtain air bags) or rollovers (head protection window curtain air bags). However, no system available today can totally eliminate injuries and fatalities.

The deployment of the air bags temporarily releases a small amount of dust from the air bags. This dust, however, is neither injurious to your health, nor does it indicate a fire in the vehicle. The dust might cause some temporary breathing difficulty for people with asthma or other breathing trouble. To avoid this, you may wish to get out of the vehicle as soon as it is safe to do so. If you have any breathing difficulty but cannot get out of the vehicle after the air bag inflates, then get fresh air by opening a window or door.

Safety and Security

Occupant safety

Warning!



To reduce the risk of injury when the front air bags inflate, it is very important for the driver and front passenger to always be in a properly seated position and to wear their respective seat belt.

For maximum protection in the event of a collision always be in normal seated position with your back against the backrest. Fasten your seat belt and make sure that it is properly positioned on your body (▷ page 46).

Since the air bag inflates with considerable speed and force, a proper seating and hands on steering wheel position will help to keep you at a safe distance from the air bag. Occupants who are unbelted, out of position or too close to the air bag can be seriously injured or killed by an air bag as it inflates with great force in the blink of an eye:

- Sit properly belted in a nearly upright position with your back against the seat backrest.

- Adjust the driver's seat as far as possible rearward, still permitting proper operation of vehicle controls. The distance from the center of the driver's breastbone to the center of the air bag cover on the steering wheel must be at least ten inches (25 cm) or more. You should be able to accomplish this by a combination of adjustments to the seat and steering wheel. If you have any problems, please see an authorized Mercedes-Benz Light Truck Center.
- Do not lean your head or chest close to the steering wheel or dashboard.
- Keep hands on the outside of steering wheel rim. Placing hands and arms inside the rim can increase the risk and potential severity of hand/arm injury when driver's front air bag inflates.
- Adjust the front passenger seat as far as possible rearward from the dashboard when the seat is occupied.

- Occupants, especially children, should never place their bodies or lean their heads in the area of the door where the side impact air bag inflates. This could result in serious injuries or death should the air bag be triggered. Always sit nearly upright, properly use the seat belts and use an appropriately sized infant or toddler restraint or booster seat recommended for the size and weight of the child.

Failure to follow these instructions can result in severe injuries to you or other occupants.

If you sell your vehicle, it is important that you make the buyer aware of this safety information. Be sure to give the buyer this Operator's Manual.

Safety and Security

Occupant safety

Warning!



Accident research shows that the safest place for children in an automobile is in the rear seat.

It should be noted that with respect to both front and rear side impact air bags there is a possibility for a side impact air bag related injury if occupants, especially children, are not properly seated or restrained when next to a side impact air bag which needs to deploy rapidly in a side impact in order to do its job.

To help avoid the possibility of injury, please follow these guidelines:

- (1) Occupants, especially children, should never place their bodies or lean their heads in the area of the door where the side impact air bag inflates. This could result in serious injuries or death should the side impact air bag be activated.

- (2) Always sit nearly upright, properly use the seat belts and for children 12 years old and under, use an appropriately sized infant or toddler restraint or booster seat recommended for the size and weight of the child.

- (3) Always wear seat belts properly.

If you believe that, even with the use of these guidelines, it would be safer for your rear seat occupants to have the rear door mounted side impact air bags deactivated, then deactivation can be accomplished upon your written request to do so at an authorized Mercedes-Benz Light Truck Center at an additional cost.

Please contact your local authorized Mercedes-Benz Light Truck Center or call our Customer Assistance Center at 1-800-FOR-MERCEdes (1-800-367-6372) for details.



Air bags are designed to deploy only in certain frontal impacts (front air bags), and in side impacts (side impact and head protection window curtain air bags) which exceed preset thresholds, and in certain rollovers (head protection window curtain air bags). Only during these events will they provide their supplemental protection.

The driver and passengers should always wear their seat belts. Otherwise it is not possible for air bags to provide their supplemental protection.

In case of other types of impacts and impacts below air bag deployment thresholds, air bags will not deploy. The driver and passenger will then be protected to the extent possible by a properly fastened seat belt. A properly fastened seat belt is also needed to provide the best possible protection in a rollover.

Safety and Security

Occupant safety

We caution you not to rely on the presence of the air bags in order to avoid wearing your seat belt.

It is important to your safety and that of your passengers that you replace deployed air bags and repair any malfunctioning air bags to make sure the vehicle will continue to provide supplemental crash protection for occupants.

Safety guidelines for the seat belt, emergency tensioning device and air bag

Warning!



- Damaged seat belts or belts that were highly stressed in an accident must be replaced and their anchoring points must also be checked. Only use belts installed or supplied by an authorized Mercedes-Benz Light Truck Center.
 - Air bags and pyrotechnic emergency tensioning devices (ETDs) are designed to function on a one-time-only basis. An air bag or ETD that is deployed must be replaced. PRE-SAFE* has electrically operated reversible pre-tensioners in addition to the pyrotechnic ETDs.
 - Do not pass belts over sharp edges. They could tear.
 - Do not make any modification that could change the effectiveness of the belts.
- Do not bleach or dye seat belts as this may severely weaken them. In a crash they may not be able to provide adequate protection.
 - No modifications of any kind may be made to any components or wiring of the SRS. This includes changing or removing any component or part of the SRS, the installation of additional trim material, badges, etc. over the steering wheel hub, front passenger front air bag cover, outboard sides of the seat backrests, door trim panels, or door frame trims, and installation of additional electrical/electronic equipment on or near SRS components and wiring. Keep area between air bags and occupants free from objects (e.g. packages, purses, umbrellas, etc.).
 - Do not hang items such as coat hangers from the coat hooks or handles over the door. These items may turn into projectiles and cause head and other injuries when curtain air bag is deployed.
 - Air bag system components will be hot after an air bag has inflated. Do not touch.

- Never place your feet on the instrument panel, dashboard, or on the seat. Always keep both feet on the floor in front of the seat.
- In addition, improper repair work on the SRS creates a risk of rendering the SRS inoperative or causing unintended air bag deployment. Work on the SRS must therefore only be performed by qualified technicians. Contact an authorized Mercedes-Benz Light Truck Center.
- For your protection and the protection of others, when scrapping the air bag unit or emergency tensioning device, our safety instructions must be followed. These instructions are available from your authorized Mercedes-Benz Light Truck Center.
- Given the considerable deployment speed, required inflation volume, and the textile structure of the air bags, there is the possibility of abrasions or other more significant injuries resulting from air bag deployment.

Warning!



Only use seat covers which have been tested and approved by Mercedes-Benz for your vehicle model. Using other seat covers may interfere with or prevent the deployment of the front side impact air bags or the rear side impact air bags*. Contact an authorized Mercedes-Benz Light Truck Center for availability.

When you sell your vehicle we strongly urge you to give notice to the subsequent owner that it is equipped with an SRS by alerting them to the applicable section in the Operator's Manual.

Safety and Security

Occupant safety

Front air bags

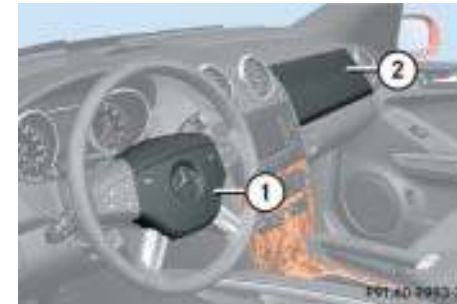

- ① Driver air bag
- ② Passenger air bag

Driver and front passenger front air bags are deployed:

- in the event of certain frontal impacts
- if impact exceeds a preset deployment threshold
- independently of the side impact air bags

Safety and Security

Occupant safety



The front air bags in this vehicle have been designed to inflate in two stages. This allows the air bag to have different rates of inflation that are based on the rate of relevant vehicle deceleration as assessed by the air bag control unit.

On the front passenger-side, the front air bag deployment is additionally influenced by the passenger's weight category as identified by the Occupant Classification System (OCS) (> page 81).

The lighter the front passenger-side occupant, the higher the vehicle deceleration rate required for the second stage inflation of the air bag.

The air bags will not deploy in impacts which do not exceed the system's deployment thresholds. You will then be protected by the fastened seat belts.

The passenger front air bag will only be deployed if:

- the system, based on OCS weight sensor readings, senses that the front passenger seat is occupied
- the  indicator lamp in the center console is not lit (> page 85)
- the impact exceeds a preset deployment threshold

Side impact air bags, window curtain air bags

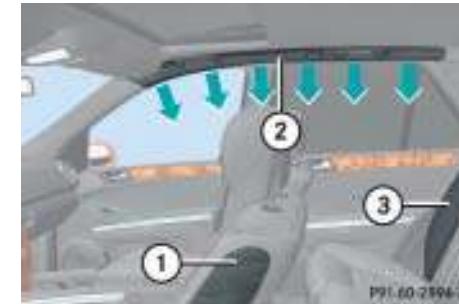

- ① Front side impact air bag
- ② Window curtain air bag
- ③ Rear side impact air bag*

The side impact air bags and window curtain air bags are deployed:

- on the impacted side of the vehicle
- in impacts exceeding a preset deployment threshold
- independently of the front air bags

In addition, the window curtain air bags ② are deployed in certain vehicle rollovers.

The front passenger side impact air bag ① will not deploy if the OCS senses that the front passenger seat is empty and the front passenger seat belt is not fastened (latch plate is not insert into the buckle). With an empty front passenger seat and the seat belt fastened (latch plate properly inserted into buckle) the front passenger side impact air bag will deploy regardless of the empty seat.

The side impact air bags and window curtain air bags are not deployed in impacts which do not exceed the system's deployment threshold.

Seat belts

Always wear your seat belt. All vehicle occupants always need to have their seat belts fastened and wear them properly.

In addition, applicable motor vehicle safety laws require you to wear seat belts. Even where this is not the case, we strongly recommend that all vehicle occupants have their seat belts fastened and wear them properly.

For more information, see "Fastening the seat belts" (▷ page 46).



For information on infants and children traveling with you in the vehicle and restraint systems for infants and children, see "Children in the vehicle" (▷ page 78).

Safety and Security

Occupant safety

Warning!



Always fasten your seat belt before driving off. Always make sure all of your passengers are properly restrained, even those sitting in the rear and pregnant women.

Failure to wear and properly fasten and position your seat belt greatly increases your risk of injuries and their likely severity in an accident. You and your passengers should always wear seat belts.

If you are ever in an accident, your injuries can be considerably more severe without your seat belt properly buckled. Without your seat belt buckled, you are much more likely to hit the interior of the vehicle or be ejected from it. You can be seriously injured or killed.

In the same crash, the possibility of injury or death is lessened if you are properly wearing your seat belt. Air bags can only protect as they are designed if the occupants are properly wearing their seat belts.

Safety and Security

Occupant safety

Warning!



Never ride in a moving vehicle with the seat backrest in an excessively reclined position as this can be dangerous. You could slide under the seat belt in a collision. If you slide under it, the belt would apply force at the abdomen or neck. That could cause serious or even fatal injuries. The seat backrest and seat belt provide the best restraint when the wearer is in a nearly upright position and the belt is properly positioned on the body.

Warning!



Never let more people ride in the vehicle than there are seat belts available. Make sure everyone riding in the vehicle is correctly restrained with a separate seat belt. Never use a seat belt for more than one person at a time.

Warning!



Damaged seat belts or belts that were highly stressed in an accident must be replaced and their anchoring points must also be checked.

Only use seat belts which have been approved by Mercedes-Benz.

Do not make any modifications to the seat belts. This can lead to unintended activation of the ETDs or to failure.

Do not bleach or dye seat belts as this may severely weaken them. In a crash they may not be able to provide adequate protection.

Have all work carried out only by qualified technicians. Contact an authorized Mercedes-Benz Light Truck Center.

Warning!



USE SEAT BELTS PROPERLY

- Seat belts can only work when used properly. Never wear seat belts in any other way than as described in this section, as that could result in serious injuries in case of an accident.
- Each occupant should wear their seat belt at all times, because seat belts help reduce the likelihood of and potential severity of injuries in accidents, including rollovers. The integrated restraint system includes SRS (driver air bag, passenger front air bag, side impact air bags, head protection window curtain air bags for side windows), ETD (seat belt emergency tensioning device), and front seat knee bolsters. The system is designed to enhance the protection offered to properly belted occupants in certain frontal (front air bags and ETD) and side (side impact, window curtain air bags and ETD) impacts which exceed preset deployment thresholds and in

Safety and Security

Occupant safety

certain rollovers (window curtain air bags and ETD).



- Never wear the shoulder belt under your arm, against your neck or off your shoulder. In a frontal crash, your body would move too far forward. That would increase the chance of head and neck injuries. The belt would also apply too much force to the ribs or abdomen, which could severely injure internal organs such as your liver or spleen.
- Never wear belts over rigid or breakable objects in or on your clothing, such as eyeglasses, pens, SmartKeys, etc., as these might cause injuries.
- Position the lap belt as low as possible on your hips and not across the abdomen. If the belt is positioned across your abdomen, it could cause serious injuries in a crash.

- Never use a seat belt for more than one person at time. Do not fasten a seat belt around a person and another person or other objects.
- Belts should not be worn twisted. In a crash, you wouldn't have the full width of the belt to distribute impact forces. The twisted belt against your body could cause injuries.
- Pregnant women should also use a lap-shoulder belt. The lap belt portion should be positioned as low as possible on the hips to avoid any possible pressure on the abdomen.
- Never place your feet on the instrument panel, dashboard or on the seat. Always keep both feet on the floor in front of the seat.
- When using a seat belt to secure infant or toddler restraints or children in booster seats, always follow the child seat manufacturer's instructions.

Enhanced seat belt reminder system

When the engine is started, the seat belt telltale  illuminates for a maximum of six seconds and a warning chime sounds to remind you and your passengers to fasten your seat belts.



If after these six seconds, the driver's or the front passenger's seat belt (with the front passenger seat occupied) are not fastened with all doors closed,

- and the vehicle speed does not exceed 15 mph (25 km/h), the seat belt telltale  remains illuminated for as long as either the driver's or front passenger's seat belt is not fastened.
- and the vehicle speed exceeds 15 mph (25 km/h), the seat belt telltale  starts flashing and a warning chime sounds with increasing intensity until both the driver's and front passenger's seat belt are fastened, or for a maximum of 60 seconds from the time the vehicle speed

Safety and Security

Occupant safety

exceeded 15 mph (25 km/h) if either the driver's or front passenger's seat belt remains unfastened.

If the driver's or front passenger's seat belt remains unfastened after 60 seconds, the seat belt telltale  stops flashing and the warning chime stops sounding. The seat belt telltale  then continues to be illuminated for as long as either the driver's or front passenger's seat belt are not fastened.

The seat belt telltale  will only go out if both the driver's and the front passenger's seat belt (with the front passenger seat occupied) are fastened, or the vehicle is standing still and a front door is opened.

For more information, see "Practical hints" (▷ page 401).

Emergency tensioning device (ETD), seat belt force limiter

The seat belts for the front and rear outer seats are equipped with emergency tensioning devices and belt force limiters.

The ETD is designed to activate in the following cases:

- in frontal or rear-end impacts exceeding a preset severity level
- in certain vehicle rollovers
- if the restraint systems are operational and functioning correctly, see  indicator lamp (▷ page 390)



The ETDs for the front seats will only activate if the front seat belt is fastened (latch plate properly inserted into buckle).

The ETDs for the rear outer seats will activate with or without the respective seat belt fastened.

In an impact, emergency tensioning devices remove slack from the belts in such a way that the seat belts fit more snugly against the body. Belt force limiters, when activated, are employed to help reduce the peak force exerted by the seat belts on occupants during a crash.

Warning!



A pyrotechnic emergency tensioning device (ETD) that was activated must be replaced.

When disposing of the pyrotechnic emergency tensioning device, our safety instructions must be followed. These are available at your authorized Mercedes-Benz Light Truck Center.

PRE-SAFE* has electrically operated reversible pre-tensioners that do not require replacement after activation.

Safety and Security

Occupant safety

Preventive occupant safety* (PRE-SAFE)[®]

Warning!



The PRE-SAFE[®] system is intended to reduce the effects of an accident on properly seat-belted vehicle occupants. Despite having the PRE-SAFE[®] system in your vehicle, the possibility of injuries occurring as a result of an accident cannot be eliminated. Therefore, you should always drive carefully and adjust your driving to the prevailing road, weather, and traffic conditions.

Your vehicle automatically takes preventive measures to better protect the occupants in the following hazardous situations:

- You execute an emergency braking maneuver and the Brake Assist System (▷ page 95) is activated.
- The PRE-SAFE[®] system detects a critical driving dynamics situation.

In such cases, the following systems are automatically activated:

- The front seat belts are pre-tensioned electrically.

Vehicles with front passenger seat memory function*:

- If the OCS senses that the front passenger seat is occupied and the seat is in an unfavorable position, it will be adjusted to a better position.

Vehicles with power tilt/sliding sunroof*:

- The tilt/sliding sunroof closes if the vehicle is in a severe skid or is spinning.



If the closing procedure of the tilt/sliding sunroof is blocked, the tilt/sliding sunroof will stop and open slightly.



The PRE-SAFE[®] system is activated in the previously described circumstances only at speeds exceeding 22 mph (35 km/h).

When the critical driving dynamic situation has passed without an accident occurring, the pre-tensioning on the seat belts is deactivated.

You can then adjust the seat and the tilt/sliding sunroof to their previous position.

If the seat belts do not release:

- ▶ Adjust the backrest or seat slightly to the rear until the seat belt tension is diminished.

The locking mechanism releases.

Safety and Security

Occupant safety

Children in the vehicle

If an infant or child is traveling with you in the vehicle:

- Secure the child using an infant or child restraint appropriate to the age and size of the child.
- Make sure the infant or child is properly secured at all times while the vehicle is in motion.

Infant and child restraint seats and information on choosing an appropriate restraint system can be obtained from any authorized Mercedes-Benz Light Truck Center.

Infant and child restraint systems

We recommend all infants and children be properly restrained at all times while the vehicle is in motion.

All lap-shoulder belts except the driver's seat belt have special seat belt retractors for secure fastening of child restraints.

To fasten a child restraint, follow child restraint instructions for mounting. Then pull the shoulder belt out completely and let it retract. During seat belt retraction, a ratcheting sound can be heard to indicate that the special seat belt retractor is activated. The belt is now locked. Push down on child restraint to take up any slack.

To deactivate, release seat belt buckle and let seat belt retract completely. To deactivate the special seat belt retractor for the front passenger seat, the front passenger seat must be in the most backward position. The seat belt can again be used in the usual manner.



Information on child seats with mounting fittings for tether anchorages (▷ page 87).

For information on LATCH-type child seat mounts (▷ page 88).



The use of infant or child restraints is required by law in all 50 states, the District of Columbia, the U.S. territories and all Canadian provinces.

Infants and small children should be seated in an appropriate infant or child restraint system properly secured by a lap/shoulder belt or, if so equipped, a top tether anchorage point and a child restraint lower anchorage system that complies with U.S. Federal Motor Vehicle Safety Standards 213 and 225 and Canadian Motor Vehicle Safety Standard 213 and 210.2.

Safety and Security

Occupant safety

Warning!



Never release the seat belt buckle while the vehicle is in motion, since the special seat belt retractor will be deactivated.

A statement by the child restraint manufacturer of compliance with this standard can be found on the instruction label on the restraint and in the instruction manual provided with the restraint.

When using any infant or child restraint system, make sure to carefully read and follow all manufacturer's instructions for installation and use.

Please read and observe warning labels affixed to the inside of the vehicle and to infant or child restraints.

Warning!



According to accident statistics, children are safer when properly restrained in the rear seating positions than in the front seating position. Thus, we strongly recommend that children be placed in the rear seats whenever possible. Regardless of seating position, children 12 years old and under must be seated and properly secured in an appropriate infant or child restraint recommended for the size and weight of the child.

The infant or child restraint must be properly secured with the vehicle's seat belt, the seat belt and top tether strap, or lower anchors and top tether strap, fully in accordance with the child seat manufacturer's instructions.

Children can be killed or seriously injured by an inflating air bag. Note the following important information when circumstances require you to place a child in the front passenger seat:





- Your vehicle is equipped with air bag technology designed to turn off the front passenger front air bag in your vehicle when the OCS senses the weight of a typical 12-month-old child or less along with the weight of a standard appropriate child restraint on the front passenger seat.
- A child in a rear-facing child restraint on the front passenger seat will be seriously injured or even killed if the front passenger front air bag inflates in a collision which could occur under some circumstances, even with the air bag technology installed in your vehicle. The only means to completely eliminate this risk is to never place a child in a rear-facing child restraint in the front seat. We therefore strongly recommend that you always place a child in a rear-facing child restraint in the back seat.



Safety and Security

Occupant safety



- If you must install a rear-facing child restraint on the front passenger seat because circumstances require you to do so, make sure that the  indicator lamp is illuminated, indicating that the front passenger front air bag is deactivated. Should the  indicator lamp not illuminate or go out while the restraint is installed, please check installation. Periodically check the  indicator lamp while driving to make sure the lamp is illuminated. If the  indicator lamp goes out or remains out, do not transport a child on the front passenger seat until the system has been repaired. A child in a rear-facing child restraint on the front passenger seat will be seriously injured or even killed if the front passenger front air bag inflates.

- If you have to place a child in a forward-facing child restraint on the front passenger seat, move the seat as far back as possible, use the proper child restraint recommended for the age, size and weight of the child, and secure child restraint with the vehicle's seat belt according to the child seat manufacturer's instructions. For children larger than the typical 12-month-old child, the front passenger front air bag may or may not be activated (▷ page 82).

Warning!



Infants and small children should never share a seat belt with another occupant. During an accident, they could be crushed between the occupant and seat belt.

A child's risk of serious or fatal injuries is significantly increased if the child restraints are not properly secured in the vehicle and/or the child is not properly secured in the child restraint.

Children too big for a toddler restraint must ride in seats using regular seat belts. Position shoulder belt across chest and shoulder, not face or neck. A booster seat may be necessary to achieve proper belt positioning for children from 41 lbs until they reach a height where a lap/shoulder belt fits properly without a booster.

Safety and Security

Occupant safety

When the child restraint is not in use, remove it from the vehicle or secure it with the seat belt to prevent the child restraint from becoming a projectile in the event of an accident.

Do not leave children unattended in the vehicle, even if the children are secured in a child restraint system. Unsupervised children in a child restraint system may use vehicle equipment and may cause an accident and/or serious personal injury.

Occupant Classification System

The Occupant Classification System (OCS) automatically turns the front passenger front air bag on or off based on the classified occupant weight category determined by weight sensor readings from the front passenger seat.



The system does not deactivate the front passenger side impact air bag, the window curtain air bag and the emergency tensioning device.

Occupants must sit properly belted in a nearly upright position with their back against the seat backrest and feet on the floor to be correctly classified. If the occupant's weight is transferred to another object in the vehicle (e.g. by leaning on armrests), the OCS may not be able to properly approximate the occupant's weight category.

Furthermore, the occupant weight may appear to increase or decrease due to objects hanging on the seat, other passengers pushing on the seat, objects lodged underneath the seat or stuffed between seat and middle console or between seat and door or due to objects applying pressure on the back of the seat. Always make sure that the seat has clearance in all directions at all times.



If your seat, including your trim cover and cushion needs to be serviced in any way, take the vehicle to your authorized Mercedes-Benz Light Truck Center.

Only seat accessories approved by Mercedes-Benz may be used.



Both driver and the front passenger should always use the  indicator lamp as an indication of whether or not the front passenger is properly positioned.

Safety and Security

Occupant safety

Warning!







If the  indicator lamp illuminates when an adult or someone larger than a small individual is in the front passenger seat, have the front passenger re-position himself or herself in the seat until the  indicator lamp goes out, or check whether objects are caught under or around the seat.

More information about air bag display messages (▷ page 401).

In the event of a collision, the air bag control unit will not allow front passenger front air bag deployment when the OCS classified the front passenger seat occupant as being up to or less than the weight of a typical 12-month-old child in a standard child restraint or if the front passenger seat is sensed as being empty.

When the OCS senses that the front passenger seat occupant is classified as being up to or less than the weight of a typical 12-month-old child in a standard child restraint, the  indicator lamp will illuminate when the engine is started and remain illuminated, indicating that the front passenger front air bag is deactivated.

When the OCS senses that the front passenger seat is classified as being empty, the  indicator lamp will illuminate when the engine is started and remain illuminated, indicating that the front passenger front air bag is deactivated.

When the OCS senses that the front passenger seat occupant is classified as being heavier than the weight of a typical 12-month-old child seated in a standard child restraint or as being a small individual (such as a young teenager or a small adult), the  indicator lamp will illuminate for approximately six seconds when the engine is started and then, depending on occupant weight sensor readings from the seat, remain illuminated or go out. With the  indicator lamp illuminated, the front passenger front air bag is deactivated. With the  indicator lamp out, the front passenger front air bag is activated.

When the OCS senses that the front passenger seat occupant is classified as an adult or someone larger than a small individual, the  indicator lamp will illuminate for approximately six seconds when the engine is started and then go out, indicating that the front passenger front air bag is activated.

Safety and Security

Occupant safety

If the  indicator lamp is illuminated, the front passenger front air bag is deactivated and will not be deployed.

If the  indicator lamp is not illuminated, the front passenger front air bag is activated and will be deployed:

- in the event of certain frontal impacts
- if impact exceeds a preset deployment threshold
- independently of the side impact air bags.

If the front passenger air bag is deployed, the rate of inflation will be influenced by:

- the rate of relevant vehicle deceleration as assessed by the air bag control unit
- front passenger's weight category as identified by the Occupant Classification System (OCS).

Warning!



According to accident statistics, children are safer when properly restrained in the rear seating positions than in the front seating position. Thus, we strongly recommend that children be placed in the rear seats whenever possible. Regardless of seating position, children 12 years old and under must be seated and properly secured in an appropriate infant or child restraint recommended for the size and weight of the child.

The infant or child restraint must be properly secured with the vehicle's seat belt, the seat belt and top tether strap, or lower anchors and top tether strap, fully in accordance with the child seat manufacturer's instructions.





Children can be killed or seriously injured by an inflating air bag. Note the following important information when circumstances require you to place a child in the front passenger seat:

- Your vehicle is equipped with air bag technology designed to turn off the front passenger front air bag in your vehicle when the system senses the weight of a typical 12-month-old child or less along with the weight of a standard appropriate child restraint on the front passenger seat.
- A child in a rear-facing child restraint on the front passenger seat will be seriously injured or even killed if the front passenger front air bag inflates in a collision which could occur under some circumstances, even with the air bag technology installed in your vehicle. The only means to completely eliminate this risk is to never place a child in a rear-facing child restraint in the front seat. We therefore strongly recommend that you always place a child in a rear-facing child restraint in the back seat.

Safety and Security

Occupant safety



- If you must install a rear-facing child restraint on the front passenger seat because circumstances require you to do so, make sure that the  indicator lamp is illuminated, indicating that the front passenger front air bag is deactivated. Should the  not illuminate or go out while the restraint is installed, please check installation. Periodically check the  indicator lamp while driving to make sure the  indicator lamp is illuminated. If the  indicator lamp goes out or remains out, do not transport a child on the front passenger seat until the system has been repaired. A child in a rear-facing child restraint on the front passenger seat will be seriously injured or even killed if the front passenger front air bag inflates.

- If you have to place a child in a forward-facing child restraint on the front passenger seat, move the seat as far back as possible, use the proper child restraint recommended for the age, size and weight of the child, and secure child restraint with the vehicle's seat belt according to the child seat manufacturer's instructions. For children larger than the typical 12-month-old child, the front passenger front air bag may or may not be activated (▷ page 82).



Deployment of the driver front air bag does not mean that the front passenger front air bag also should have deployed.

The Occupant Classification System (▷ page 81) may have determined:

- that the seat was empty or occupied by the weight up to or less than that of a typical 12-month-old child seated in a standard child restraint - both instances where the system suppresses deployment of the front passenger front air bag even though the impact met the criteria and was of sufficient severity to deploy the driver front air bag.

- that the seat was occupied by a small individual (such as a young teenager or a small adult) or a child weighing more than the weight of a typical 12-month-old child in a standard child restraint - instances where the system may suppress deployment of the front passenger front air bag even though the impact met the criteria and was of sufficient severity to deploy the driver front air bag.

The  indicator lamp is located in the center console.



①  indicator lamp

The  indicator lamp ① will be illuminated, except with the SmartKey removed from the starter switch or with the starter switch in position 0 (▷ page 34).

Safety and Security

Occupant safety

Warning!



If the **SRS** indicator lamp and the  indicator lamp are lit at the same time, there is a malfunction in the Occupant Classification System. The front passenger front air bag will be deactivated in this case. Have the system checked as soon as possible by qualified technicians. Contact an authorized Mercedes-Benz Light Truck Center.

In order to ensure proper operation of the air bag system and OCS:



- Do not place more than 4.4 lbs (2 kg) into the ruffled storage bag on the back of the front passenger seat. Otherwise, the OCS may not be able to properly approximate the occupant weight category.

Safety and Security

Occupant safety

- ▷▷ Do not place objects under and/or around the front passenger seat.
- Do not hang anything from or attach any items to the seats.
- Do not stuff objects such as books between the middle console and the front passenger seat.
- Do not move the front passenger seat backwards against stiff objects.
- Sit properly belted in a nearly upright position with your back against the seat backrest.
- Do not lean on the armrests or lift yourself from the seat by using the handle over the door as this may cause the OCS to be unable to correctly approximate the occupant weight category.
- Only have the seat repaired or replaced by an authorized Mercedes-Benz Light Truck Center.
- Read and observe all warnings in this chapter.

Self-test Occupant Classification System

After turning the SmartKey in the starter switch to position **1** or **2** or pressing the KEYLESS-GO* start/stop button once or twice, the  indicator lamp ① located in the center console illuminates. If an adult occupant is properly sitting on the front passenger seat and the system senses the occupant as being an adult, the  indicator lamp will illuminate and go out after approximately six seconds.

If the seat is not occupied and the system senses the front passenger seat as being empty, the  indicator lamp will illuminate and not go out.

Warning!



If the  indicator lamp should not illuminate, the system is not functioning. You must see an authorized Mercedes-Benz Light Truck Center before seating any child on the front passenger seat.

For more information, see the “Practical hints” section (▷ page 401).

Warning!



Never place anything between seat cushion (e.g. pillow), since it reduces the effectiveness of the Occupant Classification System. The bottom of the child seat must make full contact with the passenger seat cushion. An incorrectly mounted child seat could cause injuries to the child in case of an accident, instead of increasing protection for the child.

Follow the manufacturer’s instructions for installation of child seats.

Safety and Security

Occupant safety

Installation of infant and child restraint system

This vehicle is equipped with tether anchorages for a top tether strap at each of the rear seating positions.



- ① Anchorage ring
- ② Hook

- ▶ Release the rear seat backrest (▷ page 261).
- ▶ Fold rear seat backrest slightly forward.

- ▶ Guide top tether strap between head restraint and top of seat back.
Head restraint must be installed and positioned such that the top tether strap can pass freely between the head restraint and top of seat back.
- ▶ Make sure the tether strap is not twisted.



Example for tether strap

- ① Anchorage ring
- ② Hook
- ▶ Securely fasten hook ②, which is part of the tether strap, to anchorage ring ①.



For safety, make sure the hook has attached to the ring beyond the safety catch, as illustrated.

- ▶ Swing rear seat backrest to the rear until it engages.
- ▶ Check the rear seat backrest to be locked in its upright position (▷ page 262).

Warning!



Always lock backrest in its upright position when rear seat bench is occupied by passengers, or the extended cargo area is not in use. Check for secure locking by pushing and pulling on the backrest.

Once the top tether anchorage hook is attached, the child restraint itself can be secured. Tighten the top tether strap according to the child restraint manufacturer's instructions.

Safety and Security

Occupant safety

Child seat anchors – LATCH type

This vehicle is equipped with two LATCH (Lower Anchors and Tethers for Children) type anchors (at each of the outer rear seats) for the installation of a LATCH child seat with matching mounting fittings.



① Cover, indicator for anchor location

- ▶ If installed, pry off cover using a suitable tool (screwdriver etc.).

The anchors are now visible and accessible.



② Anchor

- ▶ Install child seat according to the manufacturer's instructions.

i

The child seat must be firmly attached in the right and left side anchors ②.

!

Make sure the seat belt for the center seat can operate freely with a child seat installed.

i

Non-LATCH type child seats may also be used and can be installed using the vehicle's seat belt system. Install child seat according to the manufacturer's instructions.

Safety and Security

Occupant safety

Warning!



Children too big for a toddler restraint must ride in seats using regular seat belts. Position shoulder belt across chest and shoulder, not face or neck. A booster seat may be necessary to achieve proper belt positioning for children from 41 lbs until they reach a height where a lap/shoulder belt fits properly without a booster.

Install child seat according to manufacturer's instructions.

The child seat must be firmly attached in the right and left side anchors ①.

An incorrectly mounted child seat may come loose during an accident which could result in serious injury or death to the child.

Damaged or impact damaged child seats or child seat mounting fittings must be replaced.

Do not leave children unattended in the vehicle, even if the children are secured in a child restraint system.

Blocking of rear door window operation

You can block the rear door window operation (e.g. when you have children riding in the rear passenger compartment).

The override switch is located on the door control panel of the driver's door.



① Override switch

Activating

- ▶ Press override switch ①.

The switch engages in the recessed position.

The rear door windows can no longer be operated using the switches located in the rear doors.



Operation of the rear door windows with the switches located on the door control panel of the driver's door is still possible.

Deactivating

- ▶ Press override switch ① again.

The switch disengages from the recessed position back to original position.

The rear door windows can again be operated using the switches located in the rear doors.

Safety and Security

Occupant safety

Warning!



Activate the override switch when children are riding in the back seats of the vehicle. The children may otherwise injure themselves, e.g. by becoming trapped in the window opening.

When leaving the vehicle, always remove the SmartKey or SmartKey with KEYLESS-GO* from the starter switch, take it with you, and lock the vehicle. Do not leave children unattended in the vehicle, or with access to an unlocked vehicle. Unsupervised use of vehicle equipment may cause an accident and/or serious personal injury.

For more information on power windows, see “Power windows” (▷ page 230).

Safety and Security

Panic alarm

▼ Panic alarm

An audible alarm and flashing exterior lamps will operate briefly.



SmartKey

① **PANIC** button



SmartKey with KEYLESS-GO*

① **PANIC** button



USA only:

This device complies with Part 15 of the FCC Rules. Operation is subject to the following two conditions:

- This device may not cause harmful interference, and

- this device must accept any interference received, including interference that may cause undesired operation.

Any unauthorized modification to this device could void the user's authority to operate the equipment.



Canada only:

This device complies with RSS-210 of Industry Canada. Operation is subject to the following two conditions:

- This device may not cause interference, and
- this device must accept any interference received, including interference that may cause undesired operation of the device.

Any unauthorized modification to this device could void the user's authority to operate the equipment.

Safety and Security

Panic alarm

Activating

- ▶ Press and hold button ① for at least one second.

Deactivating

- ▶ Press button ① again.

or

- ▶ Insert the SmartKey or the SmartKey with KEYLESS-GO* in the starter switch.

or

- ▶ Press the KEYLESS-GO* start/stop button (▷ page 36).

The SmartKey with KEYLESS-GO must be inside the vehicle.

▼ Driving safety systems

In this section you will find information on the following driving safety systems:

- ABS (Antilock Brake System)
- BAS (Brake Assist System)
- ESP (Electronic Stability Program)[®]
- EBP (Electronic Brake Proportioning)
- 4-ETS (Electronic Traction System)



In winter operation, the maximum effectiveness of the ABS, the BAS, the ESP[®], the EBP, and the 4-ETS is only achieved with winter tires (▷ page 369) or snow chains as required.

Warning!



The following factors increase the risk of accidents:

- Excessive speed, especially in turns
- Wet and slippery road surfaces
- Following another vehicle too closely

The ABS, BAS, ESP[®] and 4-ETS cannot reduce this risk.

Always adjust your driving style to the prevailing road and weather conditions.

Safety and Security

Driving safety systems

ABS

Warning!



Do not pump the brake pedal. Use firm, steady brake pedal pressure instead. Pumping the brake pedal defeats the purpose of the ABS and significantly reduces braking effectiveness.

The Antilock Brake System (ABS) regulates the brake pressure so that the wheels do not lock during braking. This allows you to maintain the ability to steer your vehicle.

The ABS is functional above a speed of approximately 5 mph (8 km/h) independent of road surface conditions.

On slippery road surfaces, the ABS will respond even to light brake pressure.

The  indicator lamp in the instrument cluster (▷ page 25) comes on when you switch on the ignition. It goes out when the engine is running.

Safety and Security

Driving safety systems

Braking

At the instant one of the wheels is about to lock up, a slight pulsation can be felt in the brake pedal, indicating that the ABS is in the regulating mode.

- ▶ Keep firm and steady pressure on the brake pedal while experiencing the pulsation.

Continuous, steady brake pedal pressure yields the advantages provided by the ABS, namely braking power and ability to steer the vehicle.

The pulsating brake pedal can be an indication of hazardous road conditions and functions as a reminder to take extra care while driving.

Emergency brake maneuver

- ▶ Keep continuous full pressure on the brake pedal.



With the ABS malfunctioning, the BAS, the ESP[®], and the 4-ETS are also switched off.

The basic driving and braking functions are still available.

Off-road – ABS

With the off-road driving program switched on (▷ page 248), the ABS designed for off-road use is automatically activated.

When applying the brakes at speeds below approximately 18 mph (30 km/h), the front wheels are locked cyclically to shorten the braking distance (dig-in effect). This affects steering the vehicle.

Warning!



The ABS cannot prevent the natural laws of physics from acting on the vehicle, nor can it increase braking or steering efficiency beyond that afforded by the condition of the vehicle brakes and tires or the traction afforded. The ABS cannot prevent accidents, including those resulting from excessive speed in turns, following another vehicle too closely, or hydroplaning. Only a safe, attentive, and skillful driver can prevent accidents. The capabilities of an ABS equipped vehicle must never be exploited in a reckless or dangerous manner which could jeopardize the user's safety or the safety of others.

For more information, see "Practical hints" (▷ page 381).

Safety and Security

Driving safety systems

BAS

The Brake Assist System (BAS) operates in emergency situations. If you apply the brakes very quickly, the BAS automatically provides full brake boost, thereby potentially reducing braking distance. Apply continuous full braking pressure until the emergency braking situation is over. The ABS will prevent the wheels from locking.

When you release the brake pedal, the brakes function again as normal. The BAS is then deactivated.

Warning!



If the BAS is malfunctioning, the brake system is still functioning, but without the additional brake boost available that BAS would normally provide in an emergency braking maneuver. Therefore, the braking distance may increase.

Warning!





The BAS cannot prevent the natural laws of physics from acting on the vehicle, nor can it increase braking efficiency beyond that afforded by the condition of the vehicle brakes and tires or the traction afforded. The BAS cannot prevent accidents, including those resulting from excessive speed in turns, following another vehicle too closely, or hydroplaning. Only a safe, attentive, and skillful driver can prevent accidents. The capabilities of a BAS equipped vehicle must never be exploited in a reckless or dangerous manner which could jeopardize the user's safety or the safety of others.

ESP[®]

The Electronic Stability Program (ESP)[®] is operational as soon as the engine is running. It monitors the vehicle's traction (force of adhesive friction between the tires and the road surface) and handling.

The ESP[®] recognizes when a wheel is spinning or if the vehicle starts to skid. By applying brakes to the appropriate wheel and by limiting engine output, the ESP[®] works to stabilize the vehicle. The ESP[®] is especially useful while driving off and on wet or slippery road surfaces. The ESP[®] also helps stabilize the vehicle during braking maneuvers.

The ESP[®] warning lamp  in the instrument cluster flashes when the ESP[®] is engaged.

The ESP[®] warning lamp  in the instrument cluster come on when you switch on the ignition. It goes out when the engine is running.

Safety and Security

Driving safety systems

Warning!



Never switch off the ESP[®] when you see the ESP[®]-warning lamp  flashing in the speedometer. In this case, proceed as follows:

- While driving off, apply as little throttle as possible.
- While driving ease up on the accelerator.
- Adapt your speed and driving style to the prevailing road conditions.

Failure to observe these guidelines could cause the vehicle to skid.

The ESP[®] cannot prevent accidents resulting from excessive speed.

Warning!



The ESP[®] cannot prevent the natural laws of physics from acting on the vehicle, nor can it increase the traction afforded. The ESP[®] cannot prevent accidents, including those resulting from excessive speed in turns, following another vehicle too closely, or hydroplaning. Only a safe, attentive, and skillful driver can prevent accidents. The capabilities of an ESP[®] equipped vehicle must never be exploited in a reckless or dangerous manner which could jeopardize the user's safety or the safety of others.



The ESP[®] will only function properly if you use wheels of the recommended tire size (▷ page 487).



Because of the ESP's[®] automatic operation, the engine and ignition must be shut off (SmartKey in starter switch position **0** or **1** or KEYLESS-GO* start/stop button* in position **0** or **1** (▷ page 34)) when

- the parking brake is being tested on a brake test dynamometer
- the vehicle is being towed with the front or rear axle raised

Active braking action through the ESP[®] may otherwise seriously damage the brake system.

Operational tests with the engine running can only be conducted on a two-axle dynamometer.

For more information, see "Practical hints" (▷ page 381).

Safety and Security

Driving safety systems

Switching off the ESP®

Warning!



The ESP® should not be switched off during normal driving other than in the circumstances described below. Disabling of the system will reduce vehicle stability in standard driving maneuvers.

Do not switch off the ESP® when a Minispare wheel is mounted.

To improve the vehicle's traction, turn off the ESP® in driving situations where it would be advantageous to have the drive wheels spin and thus cut into surfaces for better grip such as:

- starting out on slippery surfaces and in deep snow in conjunction with snow chains
- in sand or gravel



Turn ESP® on immediately if the aforementioned circumstances do not apply anymore.

When you switch off the ESP®

- the ESP® does not stabilize the vehicle
- the engine output is not limited, which allows the drive wheels to spin and thus cut into surfaces for better grip
- the 4-ETS will still brake a spinning wheel
- the ESP® continues to operate when you are braking



When the ESP® is switched off and one or more drive wheels are spinning, the ESP® warning lamp  in the instrument cluster flashes. However, the ESP® will then not stabilize the vehicle.

The switch is located on the upper center console.



① ESP® switch

- ▶ With the engine running, press ESP® switch ①.

The ESP® warning lamp  in the instrument cluster comes on. The ESP® is deactivated.

Safety and Security

Driving safety systems

Warning!



When the ESP[®] warning lamp  is illuminated continuously, the ESP[®] is switched off.

Adapt your speed and driving to the prevailing road conditions and to the non-operating status of the ESP[®].



Avoid spinning of a drive wheel for an extended period of time with the ESP[®] switched off. This may cause serious damage to the drivetrain which is not covered by the Mercedes-Benz Limited Warranty.

Switching on the ESP[®]

- ▶ Press ESP[®] switch .

The ESP[®] warning lamp  in the instrument cluster goes out.

You are now again in normal driving mode.



Turn on the ESP[®] immediately if the aforementioned circumstances do not apply anymore.

For more information, see “Practical hints” (▷ page 381).

Off-road – ESP[®]

With the off-road driving program switched on (▷ page 248), the ESP[®] designed for off-road use is automatically activated. At speeds below 27 mph (45 km/h), the ESP[®] assists in over-/understeering, thus improving vehicle traction.

EBP

The EBP enhances braking effectiveness by allowing the rear brakes to supply a greater proportion of the braking effort without a loss of vehicle stability.

4-ETS

The 4-Electronic Traction System (4-ETS) improves vehicle's ability to utilize available traction, especially under slippery road conditions. The brakes are applied to the spinning wheel and power is transferred to the wheel(s) with traction.

The ESP[®] warning lamp  in the instrument cluster, starts to flash at any vehicle speed, as soon as a tire loses traction and the wheel begins to spin.



If conditions require, switch on Off-road driving program* (▷ page 248).

Warning!



When you see ESP[®]-warning lamp  flashing in the speedometer, then proceed as follows:

- While driving off, apply as little throttle as possible.
- While driving ease up on the accelerator.
- Adapt your speed and driving style to the prevailing road conditions.

Failure to observe these guidelines could cause the vehicle to skid.

The 4-ETS cannot prevent accidents resulting from excessive speed.



Because of the ESP's[®] automatic operation, the engine must be shut off (▷ page 34) when the parking brake is being tested on a brake test dynamometer.

Active braking action through ESP[®] may otherwise seriously damage the brake system.

Operational tests with the engine running can only be conducted on a two-axle dynamometer.



If the yellow ESP[®] warning lamp  comes on while driving, the 4-ETS is being switched off temporarily to prevent overheating of the drive wheel brakes. In addition, the message ESP unavailable See Operator's Manual appears in the multifunction display.

Off-road - 4-ETS

With the off-road driving program switched on (▷ page 248), the 4-ETS designed for off-road use is automatically activated.

For more information, see the "Practical hints" section (▷ page 382) and (▷ page 387).

Safety and Security

Anti-theft systems

Immobilizer

The immobilizer prevents unauthorized persons from starting your vehicle.

Activating

With the SmartKey

- ▶ Remove the SmartKey from the starter switch.

*With KEYLESS-GO**

- ▶ Press the start/stop button on the starter switch once.
The engine is turned off.
- ▶ Open the driver's door.

Deactivating

With the SmartKey

- ▶ Turn the SmartKey in the starter switch to position **2** (▷ page 34).

*With KEYLESS-GO**

- ▶ Switch on the ignition (▷ page 34).



Starting the engine will also deactivate the immobilizer.

In case the engine cannot be started (yet the vehicle's battery is charged), the system is not operational. Contact an authorized Mercedes-Benz Light Truck Center or call 1-800-FOR-MERCEDES (in the USA), or 1-800-387-0100 (in Canada).

Anti-theft alarm system

Once the alarm system has been armed, a visual and audible alarm is triggered when someone opens

- a door
- the tailgate
- the hood

The alarm will stay on, even if the activating element (a door, for example) is immediately closed.

The alarm system will also be triggered when someone attempts to raise the vehicle, see "Tow-away alarm" (▷ page 102).



If the alarm stays on for more than 30 seconds, a call to the Response Center is initiated automatically by the Tele Aid* system (▷ page 280) provided Tele Aid service was subscribed to and properly activated, and that necessary cellular service and GPS coverage are available.

Safety and Security

Anti-theft systems

Arming the alarm system

The alarm system is armed after you have locked the vehicle with the SmartKey or SmartKey with KEYLESS-GO*.

The alarm system indicator lamp is located to the lower left of the hazard warning flasher.



① Alarm system indicator lamp

- ▶ Make sure all doors and the tailgate are closed.
- ▶ Lock the vehicle (▷ page 60).

The turn signal lamps flash three times to indicate that the alarm system is activated.

Indicator lamp ① flashes permanently to indicate that the alarm system is armed.



If the turn signal lamps do not flash three times, one of the following elements may not be properly closed:

- a door
- the tailgate

Close the respective element and lock the vehicle again.

Disarming the alarm system

- ▶ Unlock the vehicle (▷ page 32).

The turn signal lamps flash once to indicate that the alarm system is disarmed. Indicator lamp ① goes out.



The alarm system will rearm automatically again after approximately 40 seconds if one of the doors or the tailgate is not opened.



Safety and Security

Anti-theft systems

Canceling the alarm

To cancel the alarm:

With the SmartKey

- ▶ Insert the SmartKey in the starter switch.
- or
- ▶ Press the  or  button on the SmartKey.

*With KEYLESS-GO**

- ▶ Grasp an outside door handle.
The SmartKey with KEYLESS-GO must be within 3 ft (1 m) away from the respective door.
- or
- ▶ Press the KEYLESS-GO start/stop button.
The SmartKey with KEYLESS-GO must be inside the vehicle.

Tow-away alarm

Once the tow-away alarm is armed, a visual and audible alarm will be triggered when someone attempts to raise the vehicle.



The tow-away protection alarm is triggered, for example, if the vehicle is lifted on one side.

If the alarm stays on for more than 30 seconds, a call to the Response Center is initiated automatically by the Tele Aid* system (▷ page 280), provided that the Tele Aid service was subscribed to and properly activated, and that necessary cellular service and GPS coverage are available.

Arming the tow-away alarm

- ▶ Make sure all doors and the tailgate are closed.
- ▶ Lock your vehicle.

The tow-away alarm is automatically armed after about ten seconds.

Disarming the tow-away alarm

- ▶ Unlock your vehicle.



When you unlock your vehicle, the tow-away protection disarms automatically.

The tow-away alarm remains disarmed until you lock your vehicle again.

Safety and Security

Anti-theft systems

Switching off the tow-away alarm



The tow-away alarm feature can be set to default enabled (On) or disabled (Off) using the control system (▷ page 176).

To prevent triggering the tow-away alarm feature, switch off the tow-away alarm before towing the vehicle, or when parking on a surface subject to movement, such as a ferry or auto train.

If the tow-away alarm is set to default enabled (On) in the control system and you wish to retain the default setting, you can switch off the tow-away alarm temporarily on a one-time basis as follows:

- ▶ Switch off the ignition (▷ page 34).
With the tow-away alarm set to default enabled (On) in the control system, the following message appears in the multifunction display.



- ▶ If you now wish to deactivate the tow-away alarm on a one-time basis, press **+** or **-** button on the multifunction steering wheel.

The tow-away alarm is switched off. The following message appears in the multifunction display.



- ▶ Exit vehicle and lock the vehicle (▷ page 60).

The alarm system is armed independently of whether the tow-away alarm is switched on or off.



The tow-away alarm is switched off on a one-time basis only. It will be armed automatically the next time you lock the vehicle.

If you have disabled the tow-away alarm feature in the control system (▷ page 176), you can also switch on the tow-away alarm on a one-time basis as described above.

Safety and Security

Anti-theft systems



Canceling tow-away alarm

To cancel the alarm after it has been triggered:

With the SmartKey

- ▶ Insert the SmartKey in the starter switch.

or

- ▶ Press the  or  button on the SmartKey.

*With KEYLESS-GO**

- ▶ Grasp an outside door handle.

The SmartKey with KEYLESS-GO must be within 3 ft (1 m) of the vehicle.

or

- ▶ Press the KEYLESS-GO start/stop button.

The SmartKey with KEYLESS-GO must be inside the vehicle.



Controls in detail

Locking and unlocking

Seats

Memory function*

Lighting

Instrument cluster

Control system

Automatic transmission

Transfer case

Good visibility

Climate control

3-zone automatic climate control*

Power windows

Power tilt/sliding sunroof*

Driving systems

Loading

Useful features

Controls in detail

Locking and unlocking

In the “Controls in detail” section you will find detailed information on how to operate the equipment installed in your vehicle. If you are already familiar with the basic functions of your vehicle, this section will be of particular interest to you.

To quickly familiarize yourself with the basic functions of the vehicle, refer to the “Getting started” section of this manual. The corresponding page numbers are given at the beginning of each segment.

For more information on locking and unlocking, see “Getting started” (▷ page 31) and (▷ page 62).

SmartKey

Your vehicle comes supplied with two SmartKeys, each with remote control and a removable mechanical key.

The locking tabs for the mechanical key portion of the two SmartKeys are a different color to help distinguish each SmartKey unit.





The SmartKey provides an extended operating range. To prevent theft, however, it is advisable to only unlock the vehicle when you are in close proximity to it.

The SmartKey centrally locks and unlocks:

- the doors
- the tailgate
- the fuel filler flap



SmartKey with remote control

- ①  Lock button
- ②  Unlock button* for tailgate
- ③ Locking tab for mechanical key
- ④  Unlock button
- ⑤ Battery check lamp
- ⑥  PANIC button (▷ page 91)

Controls in detail

Locking and unlocking

Warning!



When leaving the vehicle, always remove the SmartKey from the starter switch, take it with you and lock the vehicle. Do not leave children unattended in the vehicle, or with access to an unlocked vehicle. It is possible for children to open a locked door from the inside, which could result in an accident and/or serious personal injury.



To prevent possible malfunction, avoid exposing the SmartKey to high levels of electromagnetic radiation.



USA only:

This device complies with Part 15 of the FCC Rules. Operation is subject to the following two conditions:

- (1) This device may not cause harmful interference, and
- (2) this device must accept any interference received, including interference that may cause undesired operation.

Any unauthorized modification to this device could void the user's authority to operate the equipment.



Canada only:

This device complies with RSS-210 of Industry Canada. Operation is subject to the following two conditions:

- (1) This device may not cause interference, and
- (2) this device must accept any interference received, including interference that may cause undesired operation of the device.

Any unauthorized modification to this device could void the user's authority to operate the equipment.



You can also open and close the power windows (▷ page 230) and tilt/sliding sunroof* (▷ page 235) using the SmartKey.

Controls in detail

Locking and unlocking

Factory setting

Global unlocking

- ▶ Press button .

All turn signal lamps flash once. The locking knobs in the doors move up. The anti-theft alarm system is disarmed.

The vehicle will lock again automatically and reactivate the anti-theft alarm system within approximately 40 seconds of unlocking if:

- neither door nor tailgate is opened
- the SmartKey is not inserted in the starter switch
- the central locking switch is not activated



Global locking

- ▶ Press button .

All turn signal lamps flash three times. The locking knobs in the doors move down. The anti-theft alarm system is armed.

Selective setting

If you frequently travel alone, you may wish to reprogram the SmartKey so that pressing  only unlocks the driver's door and the fuel filler flap.

- ▶ Press and hold buttons  and  simultaneously for about five seconds until battery check lamp  flashes twice.

The SmartKey will then function as follows:

Unlocking driver's door and fuel filler flap

- ▶ Press button  once.

All turn signal lamps flash once. The locking knob in the driver's door moves up. The anti-theft alarm system is disarmed.

Global unlocking

- ▶ Press button  twice.

All turn signal lamps flash once. The locking knobs in the doors move up. The anti-theft alarm system is disarmed.

Global locking



- ▶ Press button .

All turn signal lamps flash three times. The locking knobs in the doors move down. The anti-theft alarm system is armed.

Controls in detail

Locking and unlocking

Restoring to factory setting

- ▶ Press and hold buttons  and  and simultaneously for about six seconds until battery check lamp  flashes twice.





If you cannot lock or unlock the vehicle with the SmartKey, then either the batteries in the SmartKey are discharged, the SmartKey is malfunctioning or the vehicle battery is drained.

- Check the batteries in the SmartKey and replace them if necessary (▷ page 440).
- Use the mechanical key to unlock the driver's door (▷ page 436).
- Use the mechanical key to lock the driver's door (▷ page 436).
- Have the vehicle battery and the battery connections checked.

If the SmartKey is malfunctioning, contact an authorized Mercedes-Benz Light Truck Center.

Checking the batteries

- ▶ Press button  or .

Battery check lamp  comes on briefly to indicate that the SmartKey batteries are in order.





If battery check lamp  does not come on briefly during check, then the SmartKey batteries are discharged.

Replace the batteries (▷ page 440).

You can obtain the required batteries at any authorized Mercedes-Benz Light Truck Center.



If the batteries are checked within signal range of the vehicle, pressing the button  or  will lock or unlock the vehicle accordingly.

Unlocking and opening the tailgate (Vehicles with tailgate opening/closing system*)

You can unlock and open the tailgate separately.

A minimum height clearance of 7 ft (2.15 m) is required to open the tailgate.

- ▶ Press and hold button  on the SmartKey until the tailgate unlocks and begins to open.



The tailgate swings open upwards automatically. Always make sure there is sufficient overhead clearance.

To stop the opening procedure, press button  on the SmartKey. The tailgate stops moving.



If the vehicle was previously centrally locked, the tailgate will lock automatically when closed. The turn signals will flash three times to confirm locking.

Controls in detail

Locking and unlocking

Loss of SmartKey or mechanical key

If you lose a SmartKey or mechanical key, you should do the following:

- ▶ Have the SmartKey deactivated by an authorized Mercedes-Benz Light Truck Center.
- ▶ Report the loss of the SmartKey or the mechanical key immediately to your car insurance company.
- ▶ If necessary, have the mechanical lock replaced.

Your authorized Mercedes-Benz Light Truck Center will be glad to supply you with a replacement.

SmartKey with KEYLESS-GO*

Vehicles equipped with KEYLESS-GO come with two SmartKeys with KEYLESS-GO, each with remote control and a removable mechanical key.

The locking tabs for the mechanical key portion of the two SmartKeys with KEYLESS-GO are a different color to help distinguish each SmartKey with KEYLESS-GO unit.







The KEYLESS-GO function is integrated into the SmartKey. On these vehicles, the validity of the SmartKey with KEYLESS-GO is checked when you grasp a door handle for locking or unlocking.

If the SmartKey with KEYLESS-GO is valid, your vehicle unlocks:

- the doors
- the tailgate
- the fuel filler flap



SmartKey with KEYLESS-GO*

- ①  Lock button
- ②  Unlock button* for tailgate
- ③  Mechanical key
- ④  Unlock button
- ⑤  Battery check lamp
- ⑥  PANIC button (▷ page 91)

Controls in detail

Locking and unlocking

Warning!



When leaving the vehicle, always take the SmartKey with KEYLESS-GO* with you and lock the vehicle. Do not leave children unattended in the vehicle, or with access to an unlocked vehicle. Unsupervised use of vehicle equipment may cause an accident and/or serious personal injury.



To prevent possible malfunction, avoid exposing the SmartKey with KEYLESS-GO to high levels of electromagnetic radiation.



USA only:

This device complies with Part 15 of the FCC Rules. Operation is subject to the following two conditions:

- (1) This device may not cause harmful interference, and
- (2) this device must accept any interference received, including interference that may cause undesired operation.

Any unauthorized modification to this device could void the user's authority to operate the equipment.



Canada only:

This device complies with RSS-210 of Industry Canada. Operation is subject to the following two conditions:

- (1) This device may not cause interference, and
- (2) this device must accept any interference received, including interference that may cause undesired operation of the device.

Any unauthorized modification to this device could void the user's authority to operate the equipment.



You can also open and close the power windows (▷ page 230) and tilt/sliding sunroof* (▷ page 235) using the SmartKey with KEYLESS-GO*.

Controls in detail

Locking and unlocking

Important notes on using KEYLESS-GO*

- You can also use the SmartKey with KEYLESS-GO like a normal SmartKey (▷ page 106).
- You can combine KEYLESS-GO functions with normal SmartKey functions (e.g. unlocking with KEYLESS-GO and locking with the  button).
- Always carry the SmartKey with KEYLESS-GO with you.
- Never store the SmartKey with KEYLESS-GO together with:
 - Electronic items such as a cellular phone or another SmartKey with KEYLESS-GO
 - Metallic objects such as coins or metal foil

Doing so could impair the function of the KEYLESS-GO system.

- To lock or unlock the vehicle, the SmartKey with KEYLESS-GO must be located outside the vehicle within approximately 3 ft (1 m) of the respective door or the tailgate.
- In order to start the engine with the SmartKey with KEYLESS-GO:
 - The SmartKey with KEYLESS-GO must be located in the vehicle.
 - All doors must be closed.
 - The brake pedal must be firmly depressed. Do not depress the accelerator.
- If the SmartKey with KEYLESS-GO is positioned farther away from the vehicle, the system may no longer recognize the SmartKey with KEYLESS-GO. The vehicle then cannot be locked or the engine started via the KEYLESS-GO system.
- If the SmartKey with KEYLESS-GO is removed from the vehicle while starter switch position **1** (e.g. if passenger exits the vehicle with the SmartKey with KEYLESS-GO), the message *Key not recognized* will appear in the multi-function display while driving off.

Find the SmartKey with KEYLESS-GO or change its present location immediately (e.g. place it on the front passenger seat or insert it in shirt pocket).

- Remember that the engine can be started by anyone with a SmartKey with KEYLESS-GO that is left inside the vehicle.
Possibility 1 (One SmartKey with KEYLESS-GO in the vehicle, one SmartKey with KEYLESS-GO outside the vehicle):
If you leave the SmartKey with KEYLESS-GO behind when exiting and locking the vehicle, no message appears in the multifunction display.
Possibility 2 (One SmartKey with KEYLESS-GO in the vehicle, no SmartKey with KEYLESS-GO outside the vehicle):
When exiting and locking the vehicle, the message *Key recognized in vehicle* will appear in the multifunction display.

Factory setting

Global unlocking

- ▶ Grasp an outside door handle.
All turn signal lamps flash once. The locking knobs in the doors move up. The anti-theft alarm system is switched off.



If the vehicle has been parked for more than 72 hours, you must pull an outside door handle in order to activate the KEYLESS-GO function.

The vehicle will lock again automatically and reactivate the anti-theft alarm system within approximately 40 seconds of unlocking if:

- neither a door nor the tailgate is opened
- the central locking switch is not activated.

Controls in detail

Locking and unlocking



The vehicle could be inadvertently unlocked if the SmartKey with KEYLESS-GO is within 3 ft (1 m) of the vehicle and

- an outside door handle is splashed with water, or
- you attempt to clean an outside door handle.

Global locking

- ▶ Press lock button on an outside door handle (▷ page 64) or tailgate (▷ page 116).



All turn signal lamps flash three times. The locking knobs in the doors move down. The anti-theft alarm system is armed.

Controls in detail

Locking and unlocking

Selective setting

If you frequently travel alone, you may wish to reprogram the SmartKey with KEYLESS-GO so when you grasp the driver's door handle only the driver's door and the fuel filler flap unlocks.

- ▶ Press and hold buttons  and  simultaneously for about five seconds until battery check lamp ⑤ (▷ page 110) flashes twice.

The SmartKey with KEYLESS-GO will then function as follows:

Unlocking driver's door and fuel filler flap

- ▶ Grasp the driver's outside door handle.
All turn signal lamps flash once. The locking knob in the driver's door moves up. The anti-theft alarm system is disarmed.



Global unlocking

- ▶ Grasp any outside door handle other than the driver's outside door handle.
All turn signal lamps flash once. The locking knobs in the doors move up. The anti-theft alarm system is disarmed.

Global locking

- ▶ Press lock button on an outside door handle (▷ page 64).
All turn signal lamps flash three times. The locking knobs in the doors move down. The anti-theft alarm system is armed.

Restoring to factory setting

- ▶ Press and hold buttons  and  simultaneously for about five seconds until battery check lamp ⑤ (▷ page 110) flashes twice.





If you can no longer lock or unlock the vehicle with the SmartKey with KEYLESS-GO, then the batteries in the SmartKey are discharged, the SmartKey with KEYLESS-GO is malfunctioning or the vehicle battery is drained.

- Check the batteries in the SmartKey with KEYLESS-GO (▷ page 115) and replace them if necessary (▷ page 440).
- Use the mechanical key to unlock the driver's door (▷ page 436).

- Have the vehicle battery and the battery connections checked (▷ page 462).
- Use the mechanical key to lock the doors (▷ page 436).

If the SmartKey with KEYLESS-GO is malfunctioning, contact an authorized Mercedes-Benz Light Truck Center.

Checking the batteries

- ▶ Press button  or .

Battery check lamp  comes on briefly to indicate that the SmartKey with KEYLESS-GO batteries are in order.





If battery check lamp  (▷ page 110) does not come on briefly during check, then the SmartKey with KEYLESS-GO batteries are discharged.

Replace the batteries (▷ page 440).

You can obtain the required batteries at any authorized Mercedes-Benz Light Truck Center.



If the batteries are checked within signal range of the vehicle, pressing the button  or  will lock or unlock the vehicle accordingly.

Unlocking and opening the tailgate

You can unlock and open the tailgate separately.

A minimum height clearance of 7 ft (2.15 m) is required to open the tailgate.

Controls in detail

Locking and unlocking

The handle is located above the rear license plate recess.



- ▶ Pull on the handle
or

Vehicles with tailgate opening/closing system*:

- ▶ Press and hold button  on the SmartKey with KEYLESS-GO until the tailgate unlocks and opens.

Controls in detail

Locking and unlocking



The tailgate swings open upwards automatically. Always make sure there is sufficient overhead clearance.

Vehicles with tailgate opening/closing system*: To stop the opening procedure, press button  on the SmartKey. The tailgate stops moving.



If the vehicle was previously centrally locked, the tailgate will lock automatically when closed (> page 120). The turn signals will flash three times to confirm locking.

Locking the vehicle



① Lock button at tailgate

▶ Press the lock button at tailgate ①.

or

▶ Press the lock button at the outside door handle (> page 64).

or

▶ Vehicles with tailgate opening/closing system*, press the KEYLESS-GO locking/closing switch in the tailgate (> page 124).

The vehicle locks. The turn signals flash three times to confirm locking.

Loss of the SmartKey with KEYLESS-GO

If you lose your SmartKey with KEYLESS-GO or mechanical key, you should do the following:

- ▶ Have the SmartKey with KEYLESS-GO deactivated by an authorized Mercedes-Benz Light Truck Center.
- ▶ Report the loss of the SmartKey with KEYLESS-GO or the mechanical key immediately to your car insurance company.
- ▶ Have the mechanical lock replaced if necessary.

Your authorized Mercedes-Benz Light Truck Center will be glad to supply you with a replacement.

Controls in detail

Locking and unlocking

Opening the doors from the inside

You can open a locked door from the inside. Open door only when conditions are safe to do so.

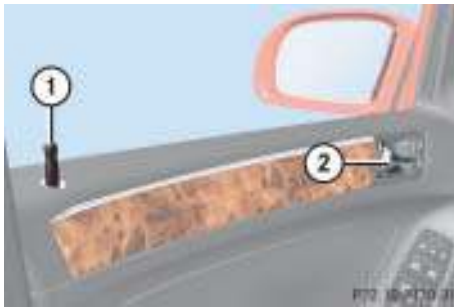



- ① Locking knob
- ② Inside door handle



If the vehicle has previously been locked with the SmartKey or SmartKey KEYLESS-GO*, opening a door from the inside will trigger the anti-theft alarm system.

To cancel the alarm, do one of the following:

With the SmartKey

- Insert the SmartKey in the starter switch.
- Press the  or  button on the SmartKey.

The SmartKey with KEYLESS-GO* must be outside the vehicle.

With KEYLESS-GO*

- Grasp an outside door handle.
- Press the KEYLESS-GO start/stop button.

The SmartKey with KEYLESS-GO must be inside the vehicle.

Front doors

- ▶ Pull on door handle ② on the respective front door to open door.

If door was locked, locking knob ① will move up.

Rear doors

- ▶ Pull up locking knob ① on the respective rear door to unlock door.
- ▶ Pull on door handle ② on the respective rear door to open door.

Controls in detail

Locking and unlocking

Opening the tailgate

Opening the tailgate from the outside

A minimum height clearance of 7 ft (2.15 m) is required to open the tailgate.

The handle is located above the rear license plate recess.



Vehicles without KEYLESS-GO*:
The vehicle must be unlocked.

- ▶ Pull on the handle.
The tailgate opens.



The tailgate swings open upwards automatically. Always make sure there is sufficient overhead clearance.

Vehicles with tailgate opening/closing system*: To stop the opening procedure, press button  on the SmartKey. The tailgate stops moving.



If the vehicle was previously centrally locked, the tailgate will lock automatically after closing it (▷ page 120). The turn signals will flash three times to confirm locking.

The tailgate can also be opened using the SmartKey (▷ page 106).

Opening the tailgate from the inside electrically*

You can open the tailgate from the inside if the vehicle is stationary.

A minimum height clearance of 7 ft (2.15 m) is required to open the tailgate.

The switch is located on the door control panel.



- ① Remote tailgate switch with indicator lamp

- ▶ Pull remote tailgate switch ① until tailgate begins to open.

The tailgate opens. The indicator lamp in the remote tailgate switch comes on and remains lit until the tailgate is closed. While the tailgate is opening an acoustic signal sounds.

Warning!



Maintain sight of the area around the rear of the vehicle while operating the tailgate with the door-mounted remote tailgate switch or with the  button on the SmartKey or SmartKey with KEYLESS-GO*. Monitor the opening procedure carefully to make sure no one is in danger of being injured.

To interrupt the opening procedure, press or pull the door-mounted remote tailgate switch or press the  button on the SmartKey or SmartKey with KEYLESS-GO*.



The tailgate swings open upwards automatically. Always make sure there is sufficient overhead clearance. To stop the opening procedure, press or pull remote tailgate switch ① or press the  button on the SmartKey or SmartKey with KEYLESS-GO*. The tailgate stops moving.



Vehicles with tailgate opening/closing system*:

The tailgate can also be opened using the button  on the SmartKey or SmartKey with KEYLESS-GO*.

Controls in detail

Locking and unlocking

Limiting opening height of tailgate*

Vehicles with tailgate opening/closing system*:

The tailgate opening height can be limited when transporting goods on a roof rack (e.g. presence of an MB sport luggage container*). When activated, the tailgate opens to approximately 6.4 ft (1.95 m).

- ▶ Activate the limiting opening height of tailgate using the control system (▷ page 173).

Controls in detail

Locking and unlocking

Closing the tailgate

Closing the tailgate from the inside electrically*

In vehicles with tailgate opening/closing system* you can close the tailgate from the inside using the remote tailgate switch.

- ▶ Press remote tailgate switch ① (▷ page 118) until tailgate begins to close.

The tailgate closes. The indicator lamp in the remote tailgate switch goes out. While the tailgate is closing an acoustic signal sounds.

To interrupt the closing procedure:

- ▶ Press or pull remote tailgate switch ①.



You can also close the tailgate by hand.

Warning!



Maintain sight of the area around the rear of the vehicle while operating the tailgate with the door mounted switch. Monitor the closing procedure carefully to make sure no one is in danger of being injured.

To interrupt the closing procedure, press or pull the door mounted remote tailgate switch.

Even with the SmartKey or the SmartKey with KEYLESS-GO* removed from the starter switch or the SmartKey with KEYLESS-GO* removed from the vehicle, the remote tailgate switch can be operated. Therefore, do not leave children unattended in the vehicle, or with access to an unlocked vehicle. Unsupervised use of vehicle equipment may cause an accident and/or serious personal injury.

Warning!



Only drive with the tailgate closed as, among other dangers such as blocked visibility, exhaust fumes may enter the vehicle interior.

If the tailgate comes into contact with an object while closing (e.g. luggage that has been piled too high) the closing procedure is stopped and the tailgate reopens.

Closing the tailgate from the outside manually



- ① Handle
- ▶ Lower tailgate by pulling firmly on handle ①.
- ▶ Close tailgate with hands placed flat on it.

Warning!



To prevent possible personal injury, always keep hands and fingers away from the cargo compartment opening when closing the tailgate. Be especially careful when small children are around.

When leaving the vehicle, always remove the SmartKey or SmartKey with KEYLESS-GO* from the starter switch, take it with you, and lock the vehicle. Do not leave children unattended in the vehicle, or with access to an unlocked vehicle. Unsupervised use of vehicle equipment may cause an accident and/or serious personal injury.

Warning!



Only drive with the tailgate closed as, among other dangers such as blocked visibility, exhaust fumes may enter the vehicle interior.

Controls in detail

Locking and unlocking



To prevent an inadvertent lockout, do not place the SmartKey in the cargo compartment.

Vehicles with KEYLESS-GO*:

To prevent a possible inadvertent lockout, the tailgate will open automatically if a SmartKey with KEYLESS-GO is recognized inside the vehicle or in the cargo compartment.



If the vehicle was previously centrally locked, the tailgate will lock automatically after closing it. The turn signals flash three times to confirm locking.

Closing the tailgate from the outside (vehicles without KEYLESS-GO*)

In vehicles with tailgate opening/closing system* you can close the tailgate separately from the outside using the tailgate closing switch or the  button on the SmartKey.

Controls in detail

Locking and unlocking



① Tailgate closing switch

- ▶ Press tailgate closing switch ① briefly. The tailgate closes.



You can also close the tailgate by hand.

If the tailgate comes into contact with an object while closing (e.g. luggage that has been piled too high), the closing procedure is stopped and the tailgate reopens.

Warning!



Monitor the closing procedure carefully to make sure no one is in danger of being injured. To prevent possible personal injury, always keep hands and fingers away from the cargo compartment opening when closing the tailgate. Be especially careful when small children are around. To stop the closing procedure, do one of the following:

- press the tailgate closing switch ①
- press the  button on the SmartKey
- press or pull the remote tailgate switch (on the driver's door)

Even with the SmartKey removed from the starter switch, the tailgate closing switch can be operated. Therefore, do not leave children unattended in the vehicle, or with access to an unlocked vehicle. Unsupervised use of vehicle equipment may cause an accident and/or serious personal injury.

Warning!



Only drive with the tailgate closed as, among other dangers such as blocked visibility, exhaust fumes may enter the vehicle interior.



Do not place the SmartKey in the open cargo compartment. You may lock yourself out.



If the vehicle was previously centrally locked, the tailgate will lock automatically after closing it. The turn signals will flash three times to confirm locking.

Closing the tailgate from the outside (vehicles with KEYLESS-GO*)

In vehicles with tailgate opening/closing system* you can close the tailgate separately from the outside using the tailgate closing switch or the  button on the SmartKey.



① Tailgate closing switch

- ▶ Make sure you have the SmartKey with KEYLESS-GO* with you.
- ▶ Press tailgate closing switch ① briefly. The tailgate closes.



You can also close the tailgate by hand.

If the tailgate comes into contact with an object while closing (e.g. luggage that has been piled too high), the closing procedure is stopped and the tailgate reopens slightly.



To prevent a possible inadvertent lock-out, the tailgate will open automatically if a SmartKey with KEYLESS-GO* is recognized inside the vehicle.

Controls in detail

Locking and unlocking

Warning!



Monitor the closing procedure carefully to make sure no one is in danger of being injured. To prevent possible personal injury, always keep hands and fingers away from the cargo compartment opening when closing the tailgate. Be especially careful when small children are around. To stop the closing procedure, do one of the following:

- press the tailgate closing switch ①
- press KEYLESS-GO locking/closing switch
- press the  button on the SmartKey with KEYLESS-GO
- press or pull the remote tailgate switch (on the driver's door)



Controls in detail

Locking and unlocking

- ▷▷ Even with the SmartKey with KEYLESS-GO* removed from the vehicle, the tailgate closing switch can be operated. Therefore, do not leave children unattended in the vehicle, or with access to an unlocked vehicle. Unsupervised use of vehicle equipment may cause an accident and/or serious personal injury.

Warning!



Only drive with the tailgate closed as, among other dangers such as blocked visibility, exhaust fumes may enter the vehicle interior.



If the vehicle was previously centrally locked, the tailgate will lock automatically after closing it. The turn signals will flash three times to confirm locking.

Closing the tailgate and locking the vehicle from the outside (vehicles with KEYLESS-GO*)

In vehicles with tailgate opening/closing system and KEYLESS-GO*, you can close the tailgate and lock the vehicle simultaneously from the outside using the KEYLESS-GO* locking/closing switch.



- ① KEYLESS-GO* locking/closing switch
- ▶ Make sure you have the SmartKey with KEYLESS-GO* with you.
 - ▶ Press switch ① briefly.

The vehicle is locked and the tailgate closes automatically. The turn signals flash three times to confirm locking. The locking knobs in the doors move down. The anti-theft alarm system is armed.



You can also close the tailgate by hand.

If the tailgate comes into contact with an object while closing (e.g. luggage that has been piled too high), the closing procedure is stopped and the tailgate reopens slightly.



To prevent a possible inadvertent lock-out, the tailgate will open automatically if a SmartKey with KEYLESS-GO* is recognized inside the vehicle.

Controls in detail

Locking and unlocking

Warning!



Monitor the closing procedure carefully to make sure no one is in danger of being injured. To prevent possible personal injury, always keep hands and fingers away from the cargo compartment opening when closing the tailgate. Be especially careful when small children are around. To stop the closing procedure, do one of the following:

- press KEYLESS-GO locking/closing switch ①
- press the tailgate closing switch
- press the  button on the SmartKey with KEYLESS-GO*
- press or pull the remote tailgate switch (on the driver's door)

Even with the SmartKey with KEYLESS-GO* removed from the vehicle, the tailgate closing switch can be operated. Therefore, do not leave children unattended in the vehicle, or with access to an unlocked vehicle. Unsupervised use of vehicle equipment may cause an accident and/or serious personal injury.

Warning!



Only drive with the tailgate closed as, among other dangers such as blocked visibility, exhaust fumes may enter the vehicle interior.

Automatic central locking

The doors and the tailgate automatically lock when the ignition is switched on and the wheels are turning at vehicle speeds of approximately 9 mph (15 km/h) or more.

You can open a locked door from the inside. Open door only when conditions are safe to do so.



The doors unlock automatically after an accident if the force of the impact exceeds a preset threshold.

The vehicle automatically locks when the ignition is switched on and the wheels are turning at vehicle speeds of approximately 9 mph (15 km/h) or more. You could therefore lock yourself out when the vehicle

- is pushed or towed
- is on a test stand
- during a wheel change

Controls in detail

Locking and unlocking

For information on towing the vehicle, see “Towing the vehicle” (▷ page 472).

You can deactivate the automatic locking mode using the control system (▷ page 172).

Locking and unlocking from the inside

You can lock or unlock the doors and the tailgate from inside using the central locking or unlocking switch. This can be useful, for example, if you want to lock the vehicle before starting to drive.

The fuel filler flap cannot be locked or unlocked with the central locking or unlocking switch, respectively.

Warning!



When leaving the vehicle, always remove the SmartKey or SmartKey with KEYLESS-GO* from the starter switch, take it with you, and lock the vehicle. Do not leave children unattended in the vehicle, or with access to an unlocked vehicle. Unsupervised use of vehicle equipment may cause an accident and/or serious personal injury.

The switches are located on each front door control panel.



- ① Central unlocking switch
- ② Central locking switch

Locking

- ▶ Press central locking switch ②.

If all doors and the tailgate are closed, the vehicle locks.



With the passenger-side door opened, you cannot lock the vehicle with the central locking switch.



You can open a locked door from the inside. Open door only when conditions are safe to do so.

If the vehicle was previously centrally locked with the SmartKey or the SmartKey with KEYLESS-GO*, it will not unlock using the central unlocking switch ②.

If the vehicle was previously locked with the central locking switch ①:

- While in the selective remote control mode, only the front door opened from the inside is unlocked.
- While in the global remote control mode, the vehicle is unlocked completely when a front door is opened from the inside.

Unlocking

- ▶ Press central unlocking switch ①.
The vehicle unlocks.

Controls in detail

Seats

For information on seat adjustment, see the “Getting started” section (▷ page 38).

For more information on seats, see “Loading” (▷ page 259).

Easy-entry/exit feature (Vehicles with memory function*)

This feature allows for easier entry into and exit from the vehicle.

The easy-entry/exit feature can be activated or deactivated in the Convenience submenu of the control system (▷ page 173).

Warning!



You must make sure no one can become trapped or injured by the moving steering wheel and driver’s seat when the easy-entry/exit feature is activated.

To stop seat/steering wheel movement, do one of the following:

- Press seat adjustment switch (▷ page 39).
- Move steering column stalk* (▷ page 42).
- Press one of the memory position buttons or the memory button **M*** (▷ page 136).

Do not leave children unattended in the vehicle, or with access to an unlocked vehicle. Children could open the driver’s door and unintentionally activate the easy-entry/exit feature, which could result in an accident and/or serious personal injury.



Do not activate the easy-entry/exit feature if the seat backrest is in an excessively reclined position. Doing so could cause damage the front or rear seats.

First move seat backrest to an upright position.

When exiting the vehicle, with the easy-entry/exit feature activated and depending on your selection, the steering wheel tilts upwards and/or the driver’s seat moves a few inches to the rear when you:

- remove the SmartKey from the starter switch,
or
- open the driver’s door with the SmartKey in starter switch position **0** or **1** or the KEYLESS-GO* start/stop button (▷ page 36) in position **1**.

Controls in detail

Seats



If the current position for the steering wheel is in the uppermost tilt position, the steering wheel will no longer be able to move upward when the easy-entry/exit feature is activated.

If the current seat position falls into a factory-set position range and the system recognizes the current seat position to be rearward enough for easy entry and exit, the driver's seat will not move to the rear when the easy-entry/exit feature is activated.

When entering the vehicle, with the easy-entry/exit feature activated, the steering wheel or, depending on your selection, the steering wheel and driver's seat will return to their last set memory position or a factory-set maximum forward position when you:

- close the driver's door with the ignition switched on
- insert the SmartKey into the starter switch or press the KEYLESS-GO* start/stop button (▷ page 36) once with the driver's door closed.



For safety reasons, the driver's seat will not return to its last set position with the easy-entry/exit feature activated if the system recognizes the last set position as an extreme forward position. Instead, the driver's seat will remain at or move to a factory-set maximum forward position. To again fully return the driver's seat to your last set position or to memory position, adjust the seat to the desired position or press and hold the respective memory position button (▷ page 136).

Controls in detail

Seats

Lumbar support

The curvature of the driver's seat can be adjusted to help enhance lower back support and seating comfort.

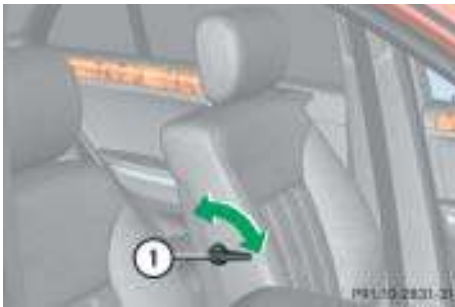

① Adjustment lever

- ▶ Move adjustment lever ① in the direction of arrows until you have reached a comfortable seating position.

Rear seat head restraints

Warning!



For safety reasons, always drive with the rear head restraints in the upright position when the rear seats are occupied.

Keep the area around head restraints clear of articles (e.g. clothing) to not obstruct the folding operation of the head restraints.

Head restraint height

Warning!



For your protection, drive only with properly positioned head restraints.

Adjust head restraint so that the center of the head restraint supports the back of the head at eye level. This will reduce the potential for injury to the head and neck in the event of an accident or similar situation.

Do not drive the vehicle without the seat head restraints. Head restraints are intended to help reduce injuries during an accident.

Do not interchange head restraints from front and rear seat.



Adjust the head restraint in such a way that it is as close to the head as possible.

For more information on seats, see the “Getting started” section (▷ page 38).

Raising:

- ▶ Manually adjust the height of the head restraint by pulling it upward.

If the head restraint is fully retracted, push release button in direction of arrow and pull the head restraint out.

Lowering:

- ▶ To lower the head restraint, push release button in direction of arrow and press down on the head restraint.

Controls in detail

Seats

Removing and installing rear seat head restraints

Warning!



For your protection, drive only with properly positioned head restraints.

Adjust head restraint so that the center of the head restraint supports the back of the head at eye level. This will reduce the potential for injury to the head and neck in the event of an accident or similar situation.

Do not drive the vehicle without the seat head restraints. Head restraints are intended to help reduce injuries during an accident.

Do not interchange head restraints from front and rear seat.

Controls in detail

Seats



Removing rear seat head restraints

- ▶ Pull head restraint to its highest position.
- ▶ Push release button in direction of arrow and pull out head restraint.

Installing rear seat head restraints

- ▶ Insert head restraint and push it down until it engages.
- ▶ Push release button and adjust head restraint to the desired position (▷ page 131).

Multicontour seat*

The multicontour seat has inflatable air cushions built into the backrest to provide additional lumbar and side support.

The seat cushion depth, backrest cushion height and curvature can be continuously varied with switches on the right side of the seat after the ignition is switched on (▷ page 34).



- ① Backrest center
- ② Backrest bottom
- ③ Seat cushion depth
- ④ Backrest side bolster

- ▶ Switch on the ignition (▷ page 34).

Controls in detail

Seats

Seat cushion depth

- ▶ Adjust the seat cushion depth to the length of your upper leg using switch ③.

Backrest contour

- ▶ Adjust the contour of the backrest to the desired position using **+** or **-**.
- ▶ Move the backrest support to the bottom using button ② or to the center using button ①.

Backrest side bolsters

- ▶ Adjust the side bolsters so that they provide good lateral support using switch ④.

Seat heating*

Both switches for the front seats are located in the center console. The red indicator lamps in the switch ① come on to show which heating level you have selected.



① Seat heating switch

Level	
off	No indicator lamps on.
1	One indicator lamp on (lowest level).
2	Two indicator lamps on. The seat heater automatically switches to level 1 after approximately ten minutes.
3	Three indicator lamps on (highest level). The seat heater automatically switches to level 2 after approximately five minutes.

- ▶ Switch on the ignition (> page 34).

Controls in detail

Seats

Switching on seat heating

- ▶ Press switch ①.
Three red indicator lamps in the switch come on.
- ▶ Continue pressing switch ① until desired seat heating level is reached.

Switching off seat heating

- ▶ Press switch ① repeatedly until all indicator lamps go out.



The seat heater will be automatically switched off after approximately 20 minutes.



If one or more of the indicator lamps on the seat heater switch are flashing, there is insufficient voltage available since too many electrical consumers are turned on. The seat heater switches off automatically.

The seat heating will switch back on again automatically as soon as sufficient voltage is available.

▼ Memory function*



Prior to operating the vehicle, the driver should check and adjust the seat height, seat position fore and aft, and seat backrest angle if necessary, to ensure adequate control, reach and comfort. The head restraint should also be adjusted for proper height. See also the section on air bags (▷ page 67) for proper seat positioning.

In addition, adjust the steering wheel to ensure adequate control, reach, operation and comfort. Both the interior and exterior rear view mirrors should be adjusted for adequate rear vision.

Fasten seat belts. Infants and small children should be seated in a properly secured restraint system that complies with U.S. Federal Motor Vehicle Safety Standard 213 and 225 and Canadian Motor Vehicle Safety Standards 213 and 210.2.

You can store up to three different settings for each SmartKey or SmartKey with KEYLESS-GO*.

The following settings are saved for each stored position on the entry side of the driver seat:

- Driver's seat, head restraint height and backrest position
- Steering wheel position
- Driver's side exterior rear view mirror position
- Passenger-side exterior rear view mirror position

The following are saved for each stored position on the entry side of the front passenger seat:

- Front passenger seat, head restraint height and backrest position

Controls in detail

Memory function*

Warning!



Do not activate the memory function while driving. Activating the memory function while driving could cause the driver to lose control of the vehicle.

Controls in detail

Memory function*

The memory button and stored position buttons are located on the entry side of each front seat base.



M Memory button

1, 2, 3 Stored positions

▶ Switch on the ignition (▷ page 34).

or

▶ Open the respective door.

Storing positions in memory

- ▶ Adjust the seats, steering wheel and exterior rear view mirrors to the desired position (▷ page 38).
- ▶ Press memory button **M**.
- ▶ Release memory button **M** and press stored position **1**, **2** or **3** within three seconds.

All the settings are stored at the selected position.

Recalling positions from memory



Do not operate the power seats using the memory button if the seat backrest is in an excessively reclined position. Doing so could cause damage to front or rear seats.

First move seat backrest to an upright position.

- ▶ Press and hold memory position button **1**, **2** or **3** until the seat, steering wheel and exterior rear view mirrors have fully moved to the stored positions.



Releasing the button immediately stops movement to the stored positions.

Controls in detail

Memory function*

Storing exterior rear view mirror parking position

For easier parking, you can adjust the passenger-side exterior rear view mirror so that you can see the right rear wheel as soon as you engage reverse gear **R**.

For information on activating the parking position feature, see “Activating exterior rear view mirror parking position*” (> page 196).



You can store a parking position for the passenger-side exterior rear view mirror for each SmartKey or SmartKey with KEYLESS-GO*.



- ① Adjustment button
- ② Passenger-side exterior rear view mirror button

- ▶ Stop the vehicle.
- ▶ Switch on the ignition (> page 34).
- ▶ Press button ②.
The passenger-side exterior rear view mirror is selected.
- ▶ Adjust the exterior rear view mirror with button ① so that you see the rear wheel and the road curb.
- ▶ Press memory button **M** (> page 136).
- ▶ Within three seconds, press bottom of adjustment button ①.
The parking position is stored if the mirror does not move.



If the mirror does move, repeat the above steps. After the setting is stored, you can move the mirror again.

Controls in detail

Lighting

For information on how to switch on the headlamps and use the turn signals, see “Switching on headlamps” (▷ page 54) and “Turn signals” (▷ page 54).



If you drive in countries where vehicles drive on the other side of the road than the country in which the vehicle is registered, you must have the headlamps modified for symmetrical low beams. Relevant information can be obtained at your authorized Mercedes-Benz Light Truck Center.



Vehicles equipped with active Bi-Xenon* headlamps: The active Bi-Xenon headlamps monitor your steering angle and driving speed, then automatically shift their beams to either side to better follow the curvature of the road ahead, increasing usable illumination over conventional headlamps.

Exterior lamp switch

The exterior lamp switch is located on the dashboard to the left of the steering wheel.



- 0** Off
Daytime running lamp mode (▷ page 140)
- AUTO** Automatic headlamp mode
Daytime running lamp mode (▷ page 139)
- Parking lamps (also tail lamps, license plate lamps, side marker lamps, instrument panel lamps)
- Low beam headlamps (or high beam headlamps when the combination switch is pushed forward) and parking lamps
- P<->** Standing lamps, right (turn left one stop)
- P≡** Standing lamps, left (turn left two stops)
- Indicator lamp for front fog lamps
- Indicator lamp for rear fog lamp

Controls in detail

Lighting



With the SmartKey removed from the starter switch and the driver's door open, a warning sounds if the parking lamps or low beam headlamps are switched on.

The message *Switch off lights* appears in the multifunction display.



With the daytime running lamp mode activated and the engine running, the low beam headlamps cannot be switched off manually.

To activate the daytime running lamp mode, see "Setting daytime running lamp mode (USA only)" (▷ page 140).

Manual headlamp mode

The low beam headlamps and the parking lamps can be switched on and off with the exterior lamp switch.

Automatic headlamp mode

The following lamps switch on and off automatically depending on the brightness of the ambient light:

- Low beam headlamps
- Tail and parking lamps
- License plate lamps
- Side marker lamps

Warning!



If the exterior lamp switch is set to **AUTO**,

- the headlamps may switch off unexpectedly when the system senses bright ambient light, for example light from oncoming traffic.
- the headlamps will not be automatically switched on under foggy conditions.

To minimize risk to you and to others, activate headlamps by turning exterior lamp switch to when driving or when traffic and/or ambient lighting conditions require you to do so.

In low ambient lighting conditions, only switch from position **AUTO** to with the vehicle at a standstill in a safe location. Switching from **AUTO** to will briefly switch off the headlamps. Doing so while driving in low ambient lighting conditions may result in an accident.

The automatic headlamp feature is only an aid to the driver. The driver is responsible for the operation of the vehicle's lights at all times.

Controls in detail

Lighting

- ▶ Turn the exterior lamp switch to position **AUTO**.

With the SmartKey in starter switch position **1**, only the parking lamps will switch on and off automatically.

When the engine is running, the low beam headlamps, the tail and parking lamps, the license plate lamps, and the side marker lamps will switch on and off automatically.

Daytime running lamp mode

- ▶ Turn the exterior lamp switch to position **0** or **AUTO**.

When the engine is running, the low beam headlamps are switched on.

In low ambient light conditions, the following lamps will switch on additionally:

- Tail and parking lamps
- License plate lamps
- Side marker lamps



For nighttime driving you should turn the exterior lamp switch to position  to permit activation of the high beam headlamps.

Canada only

The daytime running lamp mode is mandatory and therefore in a constant mode.

When the engine is running, and you shift from a driving position to position **N** or **P**, the low beam headlamps will switch off with a three-minute delay.



When the engine is running, and you

- turn the exterior lamp switch to position , the parking lamps switch on additionally.
- turn the exterior lamp switch to position , the manual headlamp mode has priority over the daytime running lamp mode.

The corresponding exterior lamps switch on (▷ page 54).

USA only

By default, the daytime running lamp mode is deactivated. Activate the daytime running lamp mode using the control system, see “Setting daytime running lamp mode (USA only)” (▷ page 167).

When the engine is running, and you turn the exterior lamp switch to position  or , the manual headlamp mode has priority over the daytime running lamp mode.

The corresponding exterior lamps switch on (▷ page 54).



Locator lighting and night security illumination

The locator lighting and the night security illumination are described in the “Control system” section, see “Setting locator lighting” (▷ page 168) and “Setting night security illumination” (▷ page 169).

Fog lamps

Warning!



In low ambient lighting or foggy conditions, only switch from position **AUTO** to  with the vehicle at a standstill in a safe location. Switching from **AUTO** to  will briefly switch off the headlamps. Doing so while driving in low ambient lighting conditions may result in an accident.



Fog lamps will operate with the parking lamps and/or the low beam headlamps on. Fog lamps should only be used in conjunction with low beam headlamps. Consult your State or Province Motor Vehicle Regulations regarding permissible lamp operation.

Controls in detail

Lighting



Fog lamps cannot be switched on with the exterior lamp switch in position **AUTO**. For switching on the fog lamps, turn the exterior lamp switch to position  first.



Controls in detail

Lighting

Front fog lamps

- ▶ Switch on the low beam headlamps (▷ page 54).
- ▶ Pull out the exterior lamp switch to first stop.

The front fog lamps switch on.

The green indicator lamp  in the exterior lamp switch comes on.

- ▶ Push in the exterior lamp switch.

The front fog lamps switch off.

The green indicator lamp  in the exterior lamp switch goes out.

Rear fog lamp (driver's side only)

- ▶ Switch on the front fog lamps (▷ page 142).
- ▶ Pull out the exterior lamp switch to second stop.

The rear fog lamp is switched on.

The yellow indicator lamp  in the exterior lamp switch comes on (▷ page 138).

- ▶ Push in the exterior lamp switch to first stop.

The rear fog lamp switches off.

The yellow indicator lamp  in the exterior lamp switch goes out.

The front fog lamps remain lit.

Combination switch

The combination switch is located on the left of the steering column.



- ① High beam
- ② High beam flasher

High beam

- ▶ Turn the exterior lamp switch to position  or **AUTO** (▷ page 138).

- ▶ Push the combination switch in direction of arrow ① to switch on the high beam.

The high beam headlamp indicator lamp  in the instrument cluster comes on (▷ page 24).

- ▶ Pull the combination switch in direction of arrow ② to its original position to switch off the high beam.

The high beam headlamp indicator lamp  in the instrument cluster goes out.

High beam flasher

- ▶ Pull the combination switch briefly in direction of arrow ②.

Corner-illuminating front fog lamps*

The corner-illuminating front fog lamps improve illumination of the road onto which you are turning.

The corner-illuminating front fog lamps will operate with the engine running and with

- the exterior lamp switch in position  (▷ page 138)
or
- the exterior lamp switch in position **AUTO** (▷ page 138)
or
- the daytime running lamp mode activated (▷ page 140)



Corner-illuminating front fog lamps will only come on in low ambient lighting conditions.

The corner-illuminating front fog lamps function is not available at a vehicle speed above 25 mph (40 km/h).

Driving forward

Switching on corner-illuminating front fog lamps

- ▶ Depending on whether you are turning left or right, switch on the left or right turn signal (▷ page 54).

The respective front fog lamp comes on and illuminates the area in the direction into which you are turning.



The corner-illuminating front fog lamps will come on automatically depending on the steering angle, even if you did not switch on either turn signal. If the corner-illuminating front fog lamps came on automatically, they will also go out automatically depending on the steering angle.

Controls in detail

Lighting

Switching off corner-illuminating front fog lamps

The combination switch for the turn signal resets automatically after major steering wheel movements. This will switch off the corner-illuminating front fog lamps if they were activated by switching on the left or right turn signal.

If the turn signal should stay on after making the turn, the turn signal and cornering fog lamp can be switched off by returning the combination switch to its original position.

Driving rearward

Switching on corner-illuminating front fog lamps

- ▶ Shift the automatic transmission in position **R**.

The inverse front fog lamp comes on automatically depending on the steering direction and steering angle.

Switching off corner-illuminating front fog lamps

- ▶ Shift the automatic transmission out of position **R**.

The respective front fog lamp goes out.

Hazard warning flasher

The hazard warning flasher can be switched on at all times, even with the SmartKey removed from the starter switch or with the SmartKey with KEYLESS-GO* removed from the vehicle.

The hazard warning flasher switches on automatically when an air bag deploys.

The hazard warning flasher switch is located on the upper part of the center console.



① Hazard warning flasher switch

Controls in detail

Lighting

Switching on hazard warning flasher

- ▶ Press hazard warning flasher switch ①.

All turn signals are flashing.



With the hazard warning flasher activated and the combination switch set for either left or right turn, only the respective turn signals will operate when the ignition is switched on.

Switching off hazard warning flasher

- ▶ Press hazard warning flasher switch ① again.



If the hazard warning flasher has been activated automatically, press hazard warning flasher switch ① once to switch it off.

Interior lighting

The controls are located in the overhead control panel.



- ① Left reading lamp on/off
- ② Cargo compartment lighting on/off
- ③ Automatic control on/off
- ④ Front interior lighting on/off
- ⑤ Right reading lamp on/off
- ⑥ Front right interior lamp
- ⑦ Right reading lamp
- ⑧ Left reading lamp
- ⑨ Front left interior lamp



The interior lighting is factory-set to automatic mode.

Controls in detail

Lighting

Automatic control

Deactivating

- ▶ Press switch ③.
The switch engages in the recessed position.
The interior lighting remains switched off, even when you
 - unlock the vehicle
 - remove the SmartKey from the starter switch
 - open a door
 - open the tailgate

Activating

- ▶ Press switch ③.
The switch disengages from its recessed position back to its original position.
The interior lighting switches on in darkness, when you
 - unlock the vehicle
 - remove the SmartKey from the starter switch
 - open a door
 - open the tailgate

The interior lamps are switched off following an adjustable time delay (▷ page 170).



If the door remains open, the interior lighting switches off automatically after approximately five minutes when the SmartKey is removed or in starter switch position 0.

An interior lamp switched on manually does not go out automatically.

Manual control

Front interior lighting

- ▶ Press front interior lighting switch ④.
The front interior lighting switches on.
- ▶ Press front interior lighting switch ④ again.
The front interior lighting switches off.

Switching left front reading lamp on and off

- ▶ Press button ①.
The left reading lamp comes on.
- ▶ Press button ① again.
The left reading lamp goes out.

Controls in detail

Lighting

Switching right front reading lamp on and off

- ▶ Press button ⑤.
The right reading lamp comes on.
- ▶ Press button ⑤ again.
The right reading lamp goes out.

Switching rear interior reading lamps on and off

The rear interior reading lamps are located above the rear side windows next to the grab handles.



① Rear interior reading lamp

- ▶ Press reading lamp ① in direction of arrow.
The reading lamp comes on.
- ▶ Press reading lamp ① in direction of arrow again.
The reading lamp goes out.

Cargo compartment lamp

The cargo compartment lamp switches on if the tailgate is opened.

If you leave the tailgate open for an extended period of time, the cargo compartment lamp will switch off automatically after approximately five minutes.

Switching cargo compartment lamp on and off manually

- ▶ Press switch ② (▷ page 145).
The cargo compartment lamp comes on.
- ▶ Press switch ② again.
The cargo compartment lamp goes out.

Door entry lamps

For better orientation in the dark, the corresponding door entry lamps will switch on in the darkness when you open a door and the automatic control is activated.

The door entry lamps will switch off when the corresponding door is closed.



If you turn the SmartKey in the starter switch to position **0** and switch off the headlamps, the door entry lamps will remain lit for approximately five minutes.

Controls in detail

Instrument cluster

For an illustration of the instrument cluster, see the “At a glance” section (▷ page 24).



- ① To dim illumination
- ② Reset button
- ③ To brighten illumination

The instrument cluster is activated when you:

- open a door
- switch on the ignition (▷ page 34)
- press the reset button ② (▷ page 24)
- switch on the exterior lamps (▷ page 54)

You can change the instrument cluster settings in the instrument cluster submenu of the control system (▷ page 164).

Instrument cluster illumination

Use buttons ① or ③ to adjust the illumination brightness for the instrument cluster.



The instrument cluster illumination is dimmed or brightened automatically to suit ambient light conditions.

The instrument cluster illumination will also be adjusted automatically when you switch on the vehicle's exterior lamps.

To brighten illumination

- ▶ Press and hold button ③ in the instrument cluster until the desired illumination is reached.

The instrument cluster illumination will brighten.



To dim illumination

- ▶ Press and hold button ① in the instrument cluster until the desired illumination is reached.

The instrument cluster illumination will dim.

Trip odometer

Make sure you are viewing the trip odometer display (▷ page 150).

- ▶ If it is not displayed, press button  or  on the multifunction steering wheel (▷ page 151) until the trip odometer appears.
- ▶ Press and hold the reset button on the instrument cluster (▷ page 148) until the trip odometer is reset.

Tachometer

The red marking on the tachometer (▷ page 24) denotes excessive engine speed.



Avoid driving at excessive engine speeds, as it may result in serious engine damage that is not covered by the Mercedes-Benz Limited Warranty.

To help protect the engine, the fuel supply is interrupted if the engine is operated within the red marking.

Outside temperature indicator

Warning!



The outside temperature indicator is not designed to serve as an ice-warning device and is therefore unsuitable for that purpose.

Indicated temperatures just above the freezing point do not guarantee that the road surface is free of ice. The road may still be icy, especially in wooded areas or on bridges.

The outside temperature is displayed in the multifunction display (▷ page 150).

The temperature sensor is located in the front bumper area. Due to its location, the sensor can be affected by road or engine heat during idling or slow driving. This means that the accuracy of the displayed temperature can only be verified by comparison to a thermometer placed next to the sensor, not by comparison to external displays (e.g. bank signs etc.).

When moving the vehicle into colder ambient temperatures (e.g. when leaving your garage), you will notice a delay before the lower temperature is displayed.

A delay also occurs when ambient temperatures rise. This prevents inaccurate temperature indications caused by heat radiated from the engine during idling or slow driving.

Controls in detail

Control system

The control system is activated as soon as the SmartKey in the starter switch is turned to position **1** or as soon as the KEYLESS-GO start/stop button* is in position **1**. The control system enables you to:

- call up information about your vehicle
- change vehicle settings

For example, you can use the control system to find out when your vehicle is next due for service, to set the language for messages in the instrument cluster display, and much more.



The displays for the audio systems (radio, CD player etc.) will appear in English, regardless of the language selected.

Warning!



A driver's attention to the road and traffic conditions must always be his/her primary focus when driving.

For your safety and the safety of others, selecting features through the multifunction steering wheel should only be done by the driver when traffic and road conditions permit it to be done safely.

Bear in mind that at a speed of just 30 mph (approximately 50 km/h), your vehicle is covering a distance of 44 feet (approximately 14 m) every second.

The control system relays information to the multifunction display.

Multifunction display

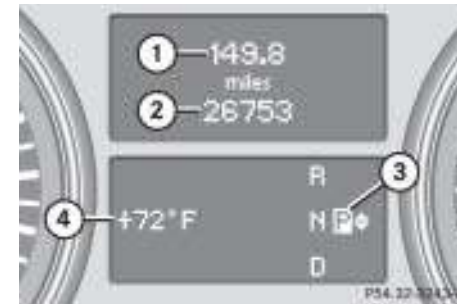

- ① Trip odometer
- ② Main odometer
- ③ Gear position indicator (currently selected gear position highlighted)
- ④ Outside temperature

For more information on menus displayed in the multifunction display, see "Menus" (▷ page 153).

Controls in detail

Control system

Multifunction steering wheel

The displays in the multifunction display and the settings in the control system are controlled by the buttons on the multifunction steering wheel.





① Multifunction display

Operating the control system

② Telephone*

Press button

 to take a call
to dial a call

 to end a call
to reject an incoming call

③ Selecting the submenu or setting the volume:

Press button

 up/to increase

 down/to decrease

④ Moving within a menu:

Press button

 for next display

 for previous display

⑤ Menu systems:

Press button

 for next menu

 for previous menu

Pressing any of the buttons on the multifunction steering wheel will alter what is shown in the multifunction display.





The information available in the multifunction display is arranged in menus, each containing a number of functions or submenus.

The individual functions are then found within the relevant menu (radio or CD operations under AUDIO, for example). These functions serve to call up relevant information or to customize the settings for your vehicle.

Controls in detail

Control system

It is helpful to think of the menus, and the functions within each menu, as being arranged in a circular pattern.

- If you press button  or  repeatedly, you will pass through each menu one after the other.
- If you press button  or  repeatedly, you will pass through each function display, one after the other, in the current menu.

In the *Settings...* menu, instead of functions you will find a number of submenus for calling up and changing settings. For instructions on using these submenus, see “Settings menu” (▷ page 161).

The number of menus available in the system depends on which optional equipment is installed in your vehicle.

The menus are described on the following pages.

Menus

This is what you will see when you scroll through the menus.

The table on the next page provides an overview of the individual menus.

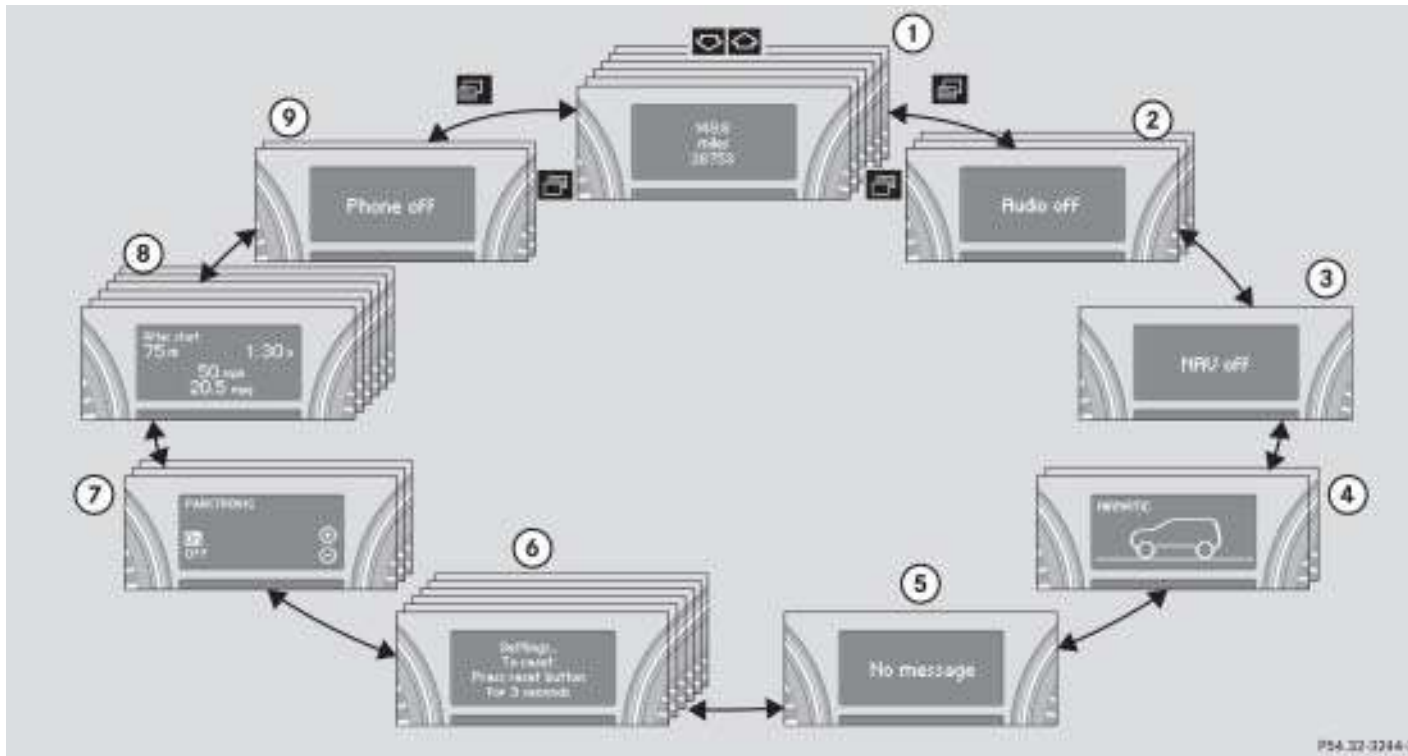

Controls in detail

Control system

Menus, submenus and functions

	Menu ① Standard display (▷ page 156)	Menu ② AUDIO (▷ page 157)	Menu ③ NAV* (▷ page 158)	Menu ④ Off-road (▷ page 159)	Menu ⑤ Vehicle status message memory (▷ page 159)	Menu ⑥ Settings (▷ page 161)
Commands/submenus	Trip odometer and Main odometer	Select radio station	Show route guidance instructions, current direction traveled	Compass	Call up vehicle malfunction, warning and system status messages stored in memory	Reset to factory settings
	Check tire inflation pressure Check coolant temperature Digital speedometer/outside temperature Call up maintenance service indicator Check engine oil level*	Select satellite radio* station Operate CD player		Vehicle level*		Instrument cluster submenu Time/Date submenu Lighting submenu Vehicle submenu Convenience submenu

	Menu ⑦ Vehicle configuration (▷ page 175)	Menu ⑧ Trip computer (▷ page 177)	Menu ⑨ Telephone* (▷ page 178)
Commands/submenus	Parktronic* DSR (Downhill Speed Regulation) programmed default speed Tow-away alarm	Fuel consumption statistics after start Fuel consumption statistics since the last reset Call up range	Load phone book Search for name in phone book



The headings used in the menus table are designed to facilitate navigation within the system and are not necessarily identical to those shown in the control system displays.

The first function displayed in each menu will automatically show you which part of the system you are in.

Controls in detail



Control system



Standard display menu

In basic mode, the multifunction display shows the trip odometer and the main odometer. This is known as the standard display.



- ① Trip odometer
- ② Main odometer



In case you see another display, press button  or  repeatedly until the standard display appears.

- ▶ Press button  or  to select the functions in the standard display menu.

The following functions are available:



Function	Page
Check engine oil level (ML 500)	328
Call up maintenance service indicator	371
Call up digital speedometer	156
Call up coolant temperature display	156
Check tire inflation pressure	347

Call up digital speedometer

- ▶ Press button  or  until the digital speedometer or the outside temperature appears in the multifunction display.

To select whether the digital speedometer or the outside temperature is shown in the multifunction display, see “Selecting display (speed display or outside temperature) for status display” (▷ page 165).

Call up coolant temperature display

- ▶ Press button  or  repeatedly until the coolant temperature appears in the multifunction display.

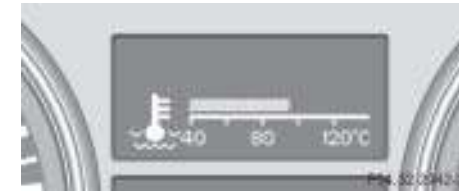

During severe operating conditions, e.g. stop-and-go traffic, the coolant temperature may rise close to 248°F (120°C).



The engine should not be operated with the coolant temperature above 248°F (120°C). Doing so may cause serious engine damage which is not covered by the Mercedes-Benz Limited Warranty.

AUDIO menu



The functions in the AUDIO menu operate the audio equipment which you currently have turned on.

If no audio equipment is currently turned on, the message AUDIO OFF is shown in the display.

The following functions are available:

Function	Page
Select radio station	157
Select satellite radio station* (USA only)	157
Operate CD player	158

Select radio station

- ▶ Turn on the Modular COMAND System and select radio. Refer to separate Modular COMAND System operating instructions.
- ▶ Press button  or  repeatedly until you see the currently tuned station in the multifunction display.



- ① Waveband setting
- ② Station frequency

- ▶ Press button  or  repeatedly until the desired station is found.

Controls in detail

Control system



You can only store new stations using the corresponding feature on the radio, see separate Modular COMAND System operating instructions.

You can also operate the radio in the usual manner.

Select satellite radio station* (USA only)

The satellite radio is treated as a radio application.

- ▶ Select satellite radio with the corresponding key on the Modular COMAND System.



- ① SAT mode and preset number
- ② Channel name or number



Controls in detail

Control system

- ▷▷ Press button  or  repeatedly until the desired channel is found.





Feature description is based on preliminary information available at time of printing.

Additional optional satellite radio equipment and a subscription to satellite radio service provider are required for satellite radio operation. At time of printing, no date for the availability of optional equipment required for satellite radio operation had been set. Contact an authorized Mercedes-Benz Light Truck Center for details and availability for your vehicle.

For more information, refer to separate Modular COMAND System operating instructions.

Operate the CD player

- ▶ Turn on the Modular COMAND System and press AUDIO on the COMAND headunit until you see the CD soft keys for CD operation. Refer to separate Modular COMAND System operating instructions.
- ▶ Press button  or  repeatedly until you see the display for the CD currently being played in the multifunction display.



- ① Current CD (for CD changer*)
- ② Current track



- ▶ Press button  or  repeatedly until the desired track is selected.



To select a CD from the magazine, press a number on the Modular COMAND system key pad located in the center console.

NAV* menu

The NAV menu contains the functions needed to operate your navigation system.



- ▶ Press button  or  repeatedly until you see the navigation display in the multifunction display:
 - If the Modular COMAND System is switched off, the message NAV off is shown in the display.
 - With the Modular COMAND System switched on but route guidance not activated, the direction of travel and, if available, the name of the street currently traveled on appear in the multifunction display.

- With the Modular COMAND system switched on and route guidance activated, the direction of travel and maneuver instructions appear in the multifunction display.

Please refer to the COMAND manual for instructions on how to activate the route guidance system.

Off-road menu

Use the *Off-road* menu to display the settings for Air suspension* and compass.



- ▶ Press button  or  repeatedly until you see one of the following messages in the multifunction display (depending on vehicle configuration):



Compass



Example Vehicle level* settings

- ▶ Press button  or  repeatedly until the desired setting is found.

Controls in detail

Control system

Vehicle status message memory menu

Use the vehicle status message memory menu to scan malfunction and warning messages that may be stored in the system. Such messages appear in the multifunction display and are based on conditions or system status the vehicle's system has recorded.



Warning!



Malfunction and warning messages are only indicated for certain systems and are intentionally not very detailed. The malfunction and warning messages are simply a reminder with respect to the operation of certain systems and do not replace the owner's and/or driver's responsibility to maintain the vehicle's operating safety by having all required maintenance and safety checks performed on the vehicle and by bringing the vehicle to an authorized Mercedes-Benz Light Truck Center to address the malfunction and warning messages.

Controls in detail

Control system

- ▶ Press button  or  repeatedly until the vehicle status message memory appears in the multifunction display.

No vehicle status messages

If no conditions have occurred, the message - depending on vehicle production date - in the display is:

No Malfunction or No Message



Depending on vehicle production date, No message instead of No malfunction will appear in the multifunction display.

Vehicle status messages have been recorded

If conditions have occurred causing status messages to be recorded, the number of messages appears in the multifunction display:



Depending on vehicle production date, 2 messages instead 2 Malfunctions of will appear in the multifunction display.

- ▶ Press button  or .

The stored messages will now be displayed in order in which they have occurred. For malfunctions and warning messages, see “Vehicle status messages in the multifunction display” (▶ page 395).



Should the vehicle’s system record any conditions while driving, the number of messages will reappear in the multifunction display when the SmartKey in the starter switch is turned to position **0** or removed from the starter switch.



The vehicle status message memory will be cleared when you turn the SmartKey in the starter switch to position **1** or **2**. You will then only see high priority messages in the multifunction display (▶ page 395).

Settings menu

In the Settings... menu there are two functions:

- The function To reset: Press reset button for 3 seconds, with which you can reset all the settings to the original factory settings.
 - A collection of submenus with which you can make individual settings for your vehicle.
- ▶ Press button  or  repeatedly until the Settings... menu is seen in the display.



Resetting all settings

You can reset all the functions of all submenus to the factory settings.

- ▶ Press the reset button in the instrument cluster (▷ page 24) for approximately three seconds.
- In the display you will see the request to press the reset button again to confirm.
- ▶ Press the reset button again.

The functions of all the submenus will reset to factory settings.



The settings you have changed will not be reset unless you confirm the action by pressing the reset button a second time.

Controls in detail

Control system

Submenus in the Settings menu

- ▶ Press button .

In the display you see the collection of the submenus.







- ▶ Press button .



The selection marker moves to the next submenu.

Controls in detail

Control system

The submenus are arranged by hierarchy. Scroll down with the  button, scroll up with the  button.

With the selection marker on the desired submenu, use the  button to access the individual functions within that submenu. Once within the submenu, you can use button  to move to the next function or button  to move to the previous function within that submenu.

The settings themselves are made with button  or .

Resetting the functions of a submenu

For each submenu you can reset all the functions to the factory settings.

- ▶ Move to a function in the submenu.
- ▶ Press the reset button (▷ page 24) in the instrument cluster for approximately three seconds.

In the display you will see the request to press the reset button again to confirm.

- ▶ Press the reset button again.

All functions of the submenu will reset to factory settings.

The table below shows what settings can be changed within the various menus. Detailed instructions on making individual settings can be found on the following pages.

INSTRUMENT CLUSTER	TIME/DATE	LIGHTING	VEHICLE	CONVENIENCE
Select speedometer display mode	Set time (hours)	Set daytime running lamp mode (USA only)	Adjusting compass zone	Activate easy-entry/exit feature*
Select language	Set time (minutes)	Set locator lighting	Calibrating compass	Set parking position for exterior rear view mirror*
Select display (speed display or outside temperature) for status line	Set date (month)	Exterior lamps delayed shut-off	Display when ignition is switched off	Set fold-in function for exterior rear view mirrors*
	Set date (day)	Interior lighting delayed shut-off	Set automatic locking	
	Set date (year)		Limiting opening height of tailgate*	

Controls in detail





Control system

Instrument cluster submenu

Access the Instr. cluster submenu using the  button via the Settings menu. Use the Instr. cluster submenu to change the instrument cluster display settings. The following functions are available:

Function	Page
Select speedometer display mode	164
Select language	164
Select display (speed display or outside temperature) for status display	165

Selecting speedometer display mode



- ▶ Move the selection marker to the Instr. cluster submenu using the  or  button.
- ▶ Press button  or  repeatedly until you see this message in the display: Display unit
Speedometer/odometer.



The selection marker is on the current setting.



- ▶ Press  or  to set speedometer unit to km or miles.



Selecting language

- ▶ Move the selection marker to the Instr. cluster submenu using the  or  button.

- ▶ Press button  or  repeatedly until you see this message in the display: Language.

The selection marker is on the current setting.



- ▶ Press  or  to select the language to be used for the multifunction display messages.

Available languages:

- German
- English
- French
- Italian
- Spanish

Controls in detail

Control system

Selecting display (speed display or outside temperature) for status display

- ▶ Move the selection marker with the **+** or **-** button to the Instr. cluster submenu.
- ▶ Press button **↕** or **↓** repeatedly until you see this message in the display: Status line display.

The selection marker is on the current setting.



- ▶ Press button **+** or **-** to select whether the speed or the outside temperature appears in the multifunction display.

Time/Date submenu

Access the Time/Date submenu via the Settings menu. Use the Time/Date submenu to change the time and date display settings. The following functions are available:

Function	Page
Set time (hours)	165
Set time (minutes)	166
Set date (month)	166
Set date (day)	166
Set date (year)	167



If your vehicle is equipped with the Modular COMAND System and navigation module, see separate COMAND manual on how to set the date and time.

Set time (hours)

This function is not available if your vehicle is equipped with the Modular COMAND System and navigation module*.

- ▶ Move the selection marker to the Time/Date submenu using the **+** or **-** button.
- ▶ Press button **↕** or **↓** repeatedly until you see this message in the display: Clock, hours.

The selection marker is on the hour setting.

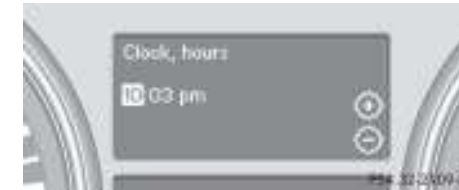

- ▶ Press button **+** or **-** to set the hour.

Controls in detail

Control system

Set time (minutes)

This function is not available if your vehicle is equipped with the Modular COMAND System and navigation module*.

- ▶ Move the selection marker to the Time/Date submenu using the **+** or **-** button.
- ▶ Press button **▲** or **▼** repeatedly until you see this message in the display: Clock, minutes.

The selection marker is on the minute setting.



- ▶ Press button **+** or **-** to set the minutes.

Set date (month)

This function is not available if your vehicle is equipped with the Modular COMAND System and navigation module*.

- ▶ Move the selection marker to the Time/Date submenu using the **+** or **-** button.
- ▶ Press button **▲** or **▼** repeatedly until you see this message in the display: Date Set month.

The selection marker is on the month setting.

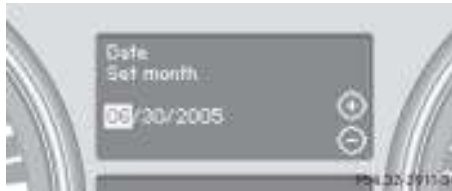

- ▶ Press button **+** or **-** to set the month.

Set date (day)

This function is not available if your vehicle is equipped with the Modular COMAND System and navigation module*.

- ▶ Move the selection marker to the Time/Date submenu using the **+** or **-** button.
- ▶ Press button **▲** or **▼** repeatedly until you see this message in the display: Date Set day.

The selection marker is on the day setting.



- ▶ Press button **+** or **-** to set the day.

Controls in detail

Control system

Set date (year)

This function is not available if your vehicle is equipped with the Modular COMAND System and navigation module*.

- ▶ Move the selection marker to the Time/Date submenu using the **+** or **-** button.
- ▶ Press button **↕** or **↩** repeatedly until you see this message in the display: Date Set year.

The selection marker is on the year setting.



- ▶ Press button **+** or **-** to set the year.

Lighting submenu

Access the Lighting submenu via the Settings... menu. Use the Lighting submenu to change the lamp and lighting settings on your vehicle. The following functions are available:

Function	Page
Set daytime running lamp mode (USA only)	167
Set locator lighting	168
Exterior lamps delayed shut-off	169
Interior lighting delayed shut-off	170

Setting daytime running lamp mode (USA only)



This function is not available in countries where daytime running lamps are mandatory.

- ▶ Move the selection marker to the Lighting submenu using the **+** or **-** button.
- ▶ Press button **↕** or **↩** repeatedly until you see this message in the display: Light circuit headlamp mode.

The selection marker is on the current setting.



Controls in detail

Control system

- ▷▷ Press **+** or **-** to select Manual or daytime running lamp (Constant) mode.

With daytime running lamp mode selected and the exterior lamp switch at position **0**, the following lamps will come on automatically when the engine is turned on:

- Parking lamps and low beam headlamps
- License plate lamps (in low ambient light conditions)



If you turn the exterior lamp switch to another position, the corresponding lamp(s) will switch on.

For safety reasons, resetting the Lighting submenu to factory settings while driving will not reset the daytime running lamp mode.

In the display you will then see the message: Lighting - Cannot be completely reset to factory settings while driving.

Setting locator lighting

With the locator lighting feature activated and the exterior lamp switch in position **AUTO**, the following lamps will switch on during darkness when the vehicle is unlocked with SmartKey:

- Parking lamps
- Tail lamps
- License plate lamps
- Side marker lamps
- Front fog lamps

The locator lighting switches off when the driver's door is opened. It switches off automatically after a period of approximately 40 seconds.

- ▶ Move the selection marker to the Lighting submenu using the **+** or **-** button.
 - ▶ Press button **▲** or **▼** repeatedly until you see this message in the display: Function Surround lighting.
- The selection marker is on the current setting.



- ▶ Press button **+** or **-** to select the desired setting.
- The locator lighting will be switched on or off.
- ▶ Turn the exterior lamp switch to position **AUTO** when exiting the vehicle (▷ page 138).

Setting night security illumination (Headlamps delayed shut-off)

Use this function to set whether and how long you would like the exterior lamps to illuminate during darkness after exiting the vehicle and all doors closed.

With the delayed shut-off feature activated and the exterior lamp switch in position **AUTO** before the engine is turned off, the following lamps will switch on when the engine is turned off:

- Parking lamps
- Tail lamps
- License plate lamps
- Side marker lamps
- Front fog lamps

Controls in detail

Control system



You can reactivate this function within ten minutes by opening a door.

If after turning off the engine you do not open a door or do not close an opened door, the lamps will automatically switch off after 60 seconds.

- ▶ Move the selection marker to the Lighting submenu using the **+** or **-** button.
- ▶ Press button **▲** or **▼** repeatedly until you see this message in the display: Headlmp. delayed shut-off.

The selection marker is on the current setting.



Controls in detail

Control system

- ▷▷▶ Press button **+** or **-** to select the desired lamp-on period.

You can select:

- 0 s, the delayed shut-off feature is deactivated.
 - 15 s, 30 s, 45 s or 60 s, the delayed shut-off feature is activated.
- ▶ Turn the exterior lamp switch to position **AUTO** before turning the engine off.

You can temporarily deactivate the delayed shut-off feature:

- ▶ Before leaving the vehicle, turn the SmartKey in the starter switch to position **0**.
- ▶ Then turn the SmartKey in the starter switch to position **2** and back to **0**.

The delayed shut-off feature is deactivated. It will reactivate as soon as you reinsert the SmartKey in the starter switch.

Vehicles with KEYLESS-GO*:

- ▶ Press KEYLESS-GO start/stop button in the starter switch (▷ page 35).

Interior lighting delayed shut-off

Use this function to set whether and for how long you would like the interior lighting to remain lit during darkness after the SmartKey is removed from the starter switch.

- ▶ Move the selection marker to the **Lighting** submenu using the **+** or **-** button.

- ▶ Press button **▲** or **▼** repeatedly until you see this message in the display: Int. illum. delayed shut-off.

The selection marker is on the current setting.



- ▶ Press button **+** or **-** to select the desired lamp-on time period. You can select:
 - 0 s, the delayed shut-off feature is deactivated.
 - 5 s, 10 s, 15 s, or 20 s, the delayed shut-off feature is activated.

Vehicle submenu

Access the Vehicle submenu via the Settings... menu. Use the Vehicle submenu to make general vehicle settings. The following functions are available:

Function	Page
Adjusting compass zone	171
Calibrating compass	171
Display when ignition is switched off	172
Set automatic locking	172
Limiting opening height of tail-gate*	173

Adjusting compass zone

This function is not available if your vehicle is equipped with the Modular COMAND System and navigation module*.

Use this function to set the compass zone.

To set the compass zone:

- ▶ Move the selection marker to the Vehicle submenu using the **+** or **-** button.
- ▶ Press button **▲** or **▼** repeatedly until you see this message in the display: Compass Adjustment Zone.

The selection marker is on the current setting.



- ▶ Press button **+** or **-** to set the respective compass zone.

Controls in detail

Control system

For information on how to select the proper geographic zone, see "Compass" (▷ page 295).

Calibrating compass

This function is not available if your vehicle is equipped with the Modular COMAND System and navigation module*.

Use this function to calibrate the compass zone.

To calibrate the compass:

- ▶ Move the selection marker to the Vehicle submenu using the **+** or **-** button.
- ▶ Press button **▲** or **▼** repeatedly until you see this message in the display: Compass Calibration.

The selection marker is on the current setting. ▷▷

Controls in detail

Control system



- ▶ Press button **+** to start calibrating the compass.

Display when ignition is switched off

Use this function to select which message will be shown in the multifunction display when the ignition is being switched off.

- ▶ Move the selection marker to the Vehicle submenu using the **+** or **-** button.

- ▶ Press button **▲** or **▼** repeatedly until you see this message in the display: Display when ignition is turned off.

The selection marker is on the current setting.



- ▶ Press button **+** or **-** to select the desired setting.

Setting automatic locking

Use this function to activate or deactivate the automatic central locking. With the automatic central locking system activated, the vehicle is centrally locked at vehicle speeds of approximately 9 mph (15 km/h).

- ▶ Move the selection marker to the Vehicle submenu using the **+** or **-** button.
- ▶ Press button **▲** or **▼** repeatedly until you see this message in the display: Automatic door lock.

The selection marker is on the current setting.



- ▶ Press button **+** or **-** to switch Automatic door lock On or Off.

Limiting opening height of tailgate*

Use this function to activate or deactivate the limiting opening height of tailgate.

- ▶ Move the selection marker to the Vehicle submenu using the **+** or **-** button.
- ▶ Press button **↕** or **↘** repeatedly until you see this message in the display: Opening limiter Tailgate.

The selection marker is on the current setting.



- ▶ Press button **+** or **-** to switch Opening limiter Tailgate On or Off.

Convenience submenu

Access the Convenience submenu via the Settings... menu. Use the Convenience submenu to change the settings for a number of convenience features. The following functions are available:

Function	Page
Activating easy-entry/exit feature*	173
Set parking position* for exterior rear view mirror	174
Setting fold-in function* for exterior rear view mirrors	175

Activating easy-entry/exit feature*

Use this function to activate and deactivate the easy-entry/exit feature (▷ page 128).

Controls in detail

Control system

Warning!



You must make sure no one can become trapped or injured by the moving steering wheel and driver's seat when the easy-entry/exit feature is activated.

To stop seat/steering wheel movement, do one of the following:

- Press seat adjustment switch (▷ page 39).
- Move steering column stalk* (▷ page 42).
- Press one of the memory position buttons or the memory button **M*** (▷ page 136).

Do not leave children unattended in the vehicle, or with access to an unlocked vehicle. Children could open the driver's door and unintentionally activate the easy-entry/exit feature, which could result in an accident and/or serious personal injury.

Controls in detail

Control system

- ▶ Move the selection marker with the **+** or **-** button to the Convenience submenu.
- ▶ Press button **▲** or **▼** repeatedly until you see this message in the multi-function display: Func. Easy-entry feature.

The selection marker is on the current setting.



- ▶ Press button **+** or **-** to change the easy-entry/exit setting.

The following settings are available for the easy-entry/exit feature:

Off	The easy-entry/exit feature is deactivated.
Steering col.	Only the steering column is moved.
Steer. col.+seat	Both the steering column and the driver's seat are moved.

Setting parking position * for exterior rear view mirror

Use the Mirror adjustment parking aid function to select whether the passenger-side exterior rear view mirror should be turned downward during parking maneuvers when reverse gear **R** is engaged. For additional information, see “Activating exterior rear view mirror parking position*” (▷ page 196).

- ▶ Move the selection marker to the Convenience submenu using the **+** or **-** button.
- ▶ Press button **▲** or **▼** repeatedly until you see this message in the display: Mirror adjustment parking assist.

The selection marker is on the current setting.

Controls in detail

Control system



- ▶ Press button **+** or **-** to switch function On or Off.

Setting fold-in function* for exterior rear view mirrors

Using this function, you can set the exterior rear view mirrors to be automatically folded (▷ page 197) in when you lock your vehicle.

- ▶ Move the selection marker with the **+** or **-** button to the Convenience submenu.

- ▶ Press button **↶** or **↷** repeatedly until you see this message Fold in mirrors when locking appears in the display.

The selection marker is on the current setting.



- ▶ Press button **+** or **-** to switch function On or Off.

Vehicle configuration

The following functions are available:

Function	Page
Parktronic* on/off	175
DSR set speed	176
Tow-away alarm on/off	176

Parktronic system* on/off

- ▶ Switch on the ignition (▷ page 34).
- ▶ Press **☰** or **☷** button repeatedly until the Vehicle configuration menu appears in the display.
- ▶ Press **↶** or **↷** repeatedly until the message PARKTRONIC appears in the display.

Controls in detail

Control system



- ▶ Press button **+** or **-** to switch function On or Off.

This setting is maintained until the ignition is switched off.

DSR (Downhill Speed Regulation) programmed default speed

In the Downhill Speed Regulation menu, you can program the default speed the DSR is set to when it is activated.

You can program the default speed between 4-10 mph (Canada: 6-18 km/h). The set value is increased in 1 mph (Canada: 2 km/h) increments.

- ▶ Press **Menu** or **Info** button repeatedly until the Vehicle configuration menu appears in the multifunction display.
- ▶ Press **Up** or **Down** button repeatedly until the message DSR Speed appears in the display.

The selection marker is on the current setting.



- ▶ Press **+** or **-** button repeatedly until the desired speed is shown in the multifunction display.

When DSR is switched on, DSR will use the programmed default speed to regulate the vehicle's speed.



Once DSR is switched on, you can adjust the set speed using the cruise control lever (▶ page 246).

Tow-away alarm on/off

You can switch off the tow-away alarm, e.g. before towing the vehicle, or when parking on a surface subject to movement, such as a ferry or auto train.

- ▶ Press **Menu** or **Info** button repeatedly until the Vehicle configuration menu appears in the display.
- ▶ Press **Up** or **Down** button repeatedly until the message Tow-away alarm appears in the display.



- ▶ Press **+** or **-** button repeatedly to switch On or Off the tow-away alarm.

Trip computer menu

Use the Trip computer menu to call up statistical data on your vehicle. The following information is available:

Function	Page
Fuel consumption statistics after start	177
Fuel consumption statistics since last reset	177
Call up range (distance to empty)	178

Fuel consumption statistics after start

- ▶ Press button **☰** or **☷** repeatedly until you see the first function of the trip computer menu.
- ▶ Press button **⬆** or **⬇** repeatedly until you see this message in the left display: After start.



- ① Distance driven since start
- ② Time elapsed since start
- ③ Average speed since start
- ④ Average fuel consumption since start



All statistics stored since the last engine start will be reset approximately four hours after the SmartKey in the starter switch is turned to position **0** or removed from the starter switch.

Resetting will not occur if you turn the SmartKey back to position **1** or **2** within this time period.

Controls in detail

Control system

Fuel consumption since last reset

- ▶ Press button **☰** or **☷** repeatedly until you see the first function of the trip computer menu.
- ▶ Press button **⬆** or **⬇** repeatedly until you see this message in the display: After reset.







- ① Distance driven since last reset
- ② Time elapsed since last reset
- ③ Average speed since last reset
- ④ Average fuel consumption since last reset





Controls in detail

Control system

Resetting fuel consumption statistics

- ▶ Press button  or  repeatedly until you see the first function of the trip computer menu.
- ▶ Press button  or  repeatedly until you see the reading that you want to reset in the display.
- ▶ Press and hold the reset button in the instrument cluster (▷ page 24) until the value is reset to 0.

Calling up range (distance to empty)

- ▶ Press button  or  repeatedly until you see the first function of the trip computer menu.
- ▶ Press button  or  repeatedly until you see this message in the display: Range :

In the display you will see the calculated range based on the current fuel tank level.



TEL menu*

Warning!





A driver's attention to the road must always be his/her primary focus when driving. For your safety and the safety of others, we recommend that you pull over to a safe location and stop before placing or taking a telephone call. If you choose to use the telephone while driving, please use the hands-free device and only use the telephone when weather, road and traffic conditions permit.

Some jurisdictions prohibit the driver from using a cellular telephone while driving a vehicle.

Bear in mind that at a speed of just 30 mph (approximately 50 km/h), your vehicle is covering a distance of 44 feet (approximately 14 m) every second.

Never operate radio transmitters equipped with a built-in or attached antenna (i.e. without being connected to an external antenna) from inside the vehicle while the engine is running. Doing so could lead to a malfunction of the vehicle's electronic system, possibly resulting in an accident and/or personal injury.

You can use the functions in the TEL menu to operate your telephone, provided it is connected to a hands-free system and switched on.

- ▶ Switch on the telephone and Modular COMAND system.
- ▶ Press button  or  on the steering wheel repeatedly until you see the TEL menu in the display.

Which messages will appear in the display field depends on whether your telephone is switched on or off:

- If the telephone is off, the message in the multifunction display is: PHONE OFF.
- If the telephone is on:

The telephone will then search for a network. During this time the display is empty.

As soon as the telephone has found a network, READY appears in the display.

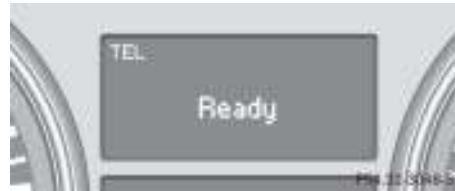

This standby message indicates that your telephone is ready for use and you can operate it using the control system.

Controls in detail

Control system

Answering a call

When your telephone is ready to receive calls, you can answer a call at any time. In the display you will then see the message:



- ▶ Press button .

You have answered the call. In the display you see the length of the call.



If you do not wish to accept a call, press button .

Controls in detail

Control system



Ending a call



- ▶ Press button .

You have ended the call. In the display you will again see the standby message.

Dialing a number from the phone book



If your telephone is ready to receive calls, you may select and dial a number from the phone book at any time.

- ▶ Press button  or  repeatedly until you see the TEL menu in the display.

- ▶ Press button  or .



The control system reads the phone book which is stored in the telephone. This may take up to four minutes. In the display you will see the message `Please wait`.

When the message `Please wait` disappears, the phone book has been loaded.

- ▶ Press button  or  repeatedly until the desired name appears in the display.

The stored names are displayed in ascending or descending alphabetical order.



If you press and hold  or  for longer than one second, the system scrolls rapidly through the list of names until you release the button again.

Cancel the quick search mode by pressing .

- ▶ Press button .

The system dials the selected phone number.

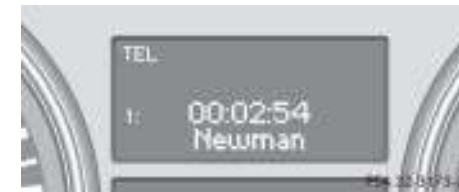

- If the connection is successful and this feature is supported by your network provider, the name of the party (if stored in your phone book) you called and the duration of the call will appear in the display.



- If no connection is made, the control system stores the dialed number in the redial memory.



Redialing

The control system stores the most recently dialed phone numbers. This eliminates the need to search through your entire phone book.

- ▶ Press button  or  repeatedly until you see the Tel menu in the display.

- ▶ Press button .

In the display you see the first number in the redial memory.

- ▶ Press button  or  repeatedly until the desired name appears in the display.

- ▶ Press button .

The control system dials the selected phone number.

Controls in detail

Automatic transmission

For more information on driving with an automatic transmission, see “Automatic transmission” section (▷ page 49).

Your vehicle’s transmission adapts its gear shifting process to your individual driving style by continually adjusting the shift points up or down. These shift point adjustments are performed based on current operating and driving conditions.

If the operating conditions change, the automatic transmission reacts by adjusting its shift program.



During the brief warm-up, transmission upshifting is delayed. This allows the catalytic converter to heat up more quickly to operating temperature.

Gear selector lever

The gear selector lever is located on the right of the steering column.



Gearshift pattern for automatic transmission

- P** Park position
- R** Reverse gear
- N** Neutral
- D** Drive position

Warning!



It is dangerous to shift the transmission out of park position **P** or neutral position **N** if the engine speed is higher than idle speed. If your foot is not firmly on the brake pedal, the vehicle could accelerate quickly forward or reverse. You could lose control of the vehicle and hit someone or something. Only shift into gear when the engine is idling normally and when your right foot is firmly on the brake pedal.

Shifting from P to N

Moving the gear selector lever up or down shifts the automatic transmission out of park position **P**:

- ▶ Depress the brake pedal and keep it pressed.
- ▶ Move gear selector lever up or down to resistance point to select neutral position **N**.

Shifting from N to D or from N to R

- ▶ Depress the brake pedal and keep it pressed.
- ▶ Move gear selector lever up past the resistance point to select reverse gear **R**.

or

- ▶ Move gear selector lever down past the resistance point to select drive position **D**.



The gear selector lever returns to its original position.

- ▶ Release the parking brake.

Shifting from P to R

- ▶ Depress the brake pedal and keep it pressed.
- ▶ Move gear selector lever up past the resistance point to select reverse gear **R**.



The gear selector lever returns to its original position.

- ▶ Release the parking brake.
- ▶ Release the brake.
- ▶ Carefully depress the accelerator pedal.

Shifting from P to D

- ▶ Depress the brake pedal and keep it pressed.
- ▶ Move gear selector lever down past the resistance point to select drive position **D**.



The gear selector lever returns to its original position.

- ▶ Release the parking brake.
- ▶ Release the brake.
- ▶ Carefully depress the accelerator pedal.

Controls in detail

Automatic transmission

Shifting from D, R, or N to P

If you want to select park position **P** with the transmission being in drive position **D**, reverse position **R** or neutral position **N**:

- ▶ Depress the brake pedal and keep it pressed.
- ▶ Step firmly on parking brake pedal (▷ page 52).
- ▶ Press button at the end of the gear selector lever in direction of arrow (▷ page 182) to select park position **P**.
- ▶ Release the brake.



Shift the automatic transmission directly from position **D** to **R**, from **R** to **D** or directly to position **P** only when the vehicle is stopped. Otherwise the automatic transmission could be damaged.

When trying to free a vehicle stuck in mud or snow, see “Rocking the vehicle” (▷ page 191).

Shifting procedure

The automatic transmission selects individual drive gears automatically, depending on:

- drive position **D** with gear ranges (▷ page 187)
- the position of the accelerator pedal (▷ page 190)
- the vehicle speed

The current transmission gear selection appears in the multifunction display.



Allow engine to warm up under low load use. Do not place full load on the engine until the operating temperature has been reached.

Shift into reverse gear **R** or park position **P** only when the vehicle is stopped.

Avoid spinning of a drive wheel for an extended period when driving off on slippery road surfaces. This may cause serious damage to the drivetrain which is not covered by the Mercedes-Benz Limited Warranty.

With gear position **D** selected, you can use the steering wheel gearshift control buttons (▷ page 189) to influence transmission shifting by:

- limiting the gear range
- changing gears manually

Transmission positions

	Effect
P	Park position Shift into park position P only when vehicle is stopped. The park position is not intended to serve as a brake when the vehicle is parked. Rather, the driver should always set the parking brake in addition to shifting into park position P to secure the vehicle.



SmartKey:

If you turn off the engine using the SmartKey and remove the SmartKey from the starter switch, the transmission automatically will shift to park position **P**. Keep in mind that turning off the engine with the SmartKey alone will not automatically shift the transmission to **P**. Only when the SmartKey is removed from the starter switch will the transmission automatically shift to **P**.

KEYLESS-GO*:

If you turn off the engine using the KEYLESS-GO start/stop button and open the driver's door, the transmission automatically will shift to park position **P**. Keep in mind that turning off the engine using the KEYLESS-GO start/stop button alone will not automatically shift the transmission to **P**. Only when the driver's door is opened will the transmission automatically shift to **P**.

Controls in detail

Automatic transmission

Even though this is possible, make it a practice to always shift into park position **P** before turning off the engine and removing the SmartKey from the starter switch, or when using KEYLESS-GO*, before turning off the engine with the start/stop button and opening the driver's door.

Warning!



If you want the gear position to remain in **N** (for example when the vehicle is pulled through a car wash), do not remove the SmartKey from the starter switch or, when using KEYLESS-GO*, do not turn off the engine using the KEYLESS-GO start/stop button* and open the driver's door. Otherwise, the transmission will shift to **P** and lock the wheels, preventing the vehicle from being pulled through a car wash.

Controls in detail

Automatic transmission

	Effect
R	<p>Reverse gear</p> <p>Shift into reverse gear R only when the vehicle is stopped.</p>
N	<p>Neutral</p> <p>No power is transmitted from the engine to the drive axle. When the brakes are released, the vehicle can be moved freely (pushed or towed).</p> <p>To avoid damage to the transmission, never shift into position N while driving.</p> <p>If the ESP[®] is deactivated or malfunctioning: Shift into position N only if the vehicle is in danger of skidding, e.g. on icy roads.</p>
D	<p>Drive</p> <p>The transmission shifts automatically. All forward gears are available.</p>



Coasting the vehicle, or driving for any other reason in position **N** can result in transmission damage that is not covered by the Mercedes-Benz Limited Warranty.

Warning!



Getting out of your vehicle without shifting into position **P** is dangerous. Also, position **P** alone is not intended to or capable of preventing your vehicle from moving, possibly hitting people or objects.

Always set the parking brake in addition to shifting to position **P** (▷ page 52).

When parked on an incline, turn the front wheels towards the road curb.

Do not park this vehicle in areas where combustible materials such as grass, hay or leaves can come into contact with the hot exhaust system, as these materials could be ignited and cause a vehicle fire.

Controls in detail

Automatic transmission

Warning!



When leaving the vehicle, always remove the SmartKey or SmartKey with KEYLESS-GO* from the starter switch, take it with you, and lock the vehicle. Do not leave children unattended in the vehicle, or with access to an unlocked vehicle. Children could shift the transmission out of position **P**, which could result in an accident and/or serious personal injury.

Gear ranges

With the automatic transmission in drive position **D**, you can limit the transmission's gear range by pressing the inside of one of the steering wheel gearshift buttons, and reverse the gear range limit by pressing the outside of one of the steering wheel gearshift buttons. The steering wheel gearshift buttons are located on the back of the steering wheel (▷ page 189).

The selected gear range appears in the multifunction display.



If you press on the accelerator when the engine has reached its rpm limit, the transmission will upshift beyond any gear range limit selected.

Effect

D	The transmission shifts through all seven forward gears.
6	The transmission shifts through sixth gear only.
5	The transmission shifts through fifth gear only.
4	The transmission shifts through fourth gear only.
3	The transmission shifts through third gear only.
	With this selection you can use the braking effect of the engine.

Controls in detail

Automatic transmission

	Effect
2	<p>The transmission shifts through second gear only.</p> <p>Allows the use of engine's braking power when driving:</p> <ul style="list-style-type: none"> • on steep downgrades • in mountainous regions • under extreme operating conditions
1	<p>The transmission operates in first gear only.</p> <p>For maximum use of engine's braking effect on very steep or lengthy downgrades.</p>

Steering wheel gearshift control

With drive position **D** selected, you can use the steering wheel gearshift control buttons to manually shift the gears. When doing so, you are also limiting or extending the gear range.



To avoid overrevving the engine when downshifting with steering wheel gearshift buttons, the transmission will not shift to a lower gear if the engine's max. speed would be exceeded.



Allow engine to warm up under low load use. Do not place full load on the engine until the operating temperature has been reached.

Shift into reverse gear **R** or park position **P** only when the vehicle is stopped.

Avoid spinning of a drive wheel for an extended period when driving off on slippery road surfaces. This may cause serious damage to the drivetrain which is not covered by the Mercedes-Benz Limited Warranty.

The steering wheel gearshift buttons are located to the left and right of the steering wheel.



- ① Button, inside: downshift
- ② Button, outside: upshift



You cannot shift with the steering wheel gearshift buttons when the transmission is in position **P**, **N** or **R**.

Downshifting

Warning!



On slippery road surfaces, never downshift in order to obtain braking action. This could result in drive wheel slip and reduced vehicle control. Your vehicle's ABS will not prevent this type of loss of control.

- ▶ Briefly press the inside of one of the buttons ① on the steering wheel.

The transmission will shift to the next lower gear as permitted by the shift program. This action simultaneously limits the gear range of the transmission (▷ page 187).

Controls in detail

Automatic transmission

Upshifting

- ▶ Briefly press the outside of one of the buttons ② on the steering wheel.

The transmission will shift to the next higher gear as permitted by the shift program. This action simultaneously extends the gear range of the transmission (▷ page 187).

Controls in detail

Automatic transmission

Shifting into optimal gear range

- ▶ Press and hold the inside of one of the buttons ① on the steering wheel (▷ page 189).

The transmission will automatically select the gear range suited for optimal acceleration and deceleration. This will involve shifting down one or more gears.

Canceling gear range limit

- ▶ Press and hold the outside of one of the buttons ② on the steering wheel (▷ page 189) until D reappears in the multifunction display.

The transmission will shift from the current gear range directly to gear range **D**.

Driving tips

Accelerator position

Your driving style influences the transmission's shifting behavior:

Less throttle	Earlier upshifting
More throttle	Later upshifting

Kickdown

Use kickdown when you want maximum acceleration.

- ▶ Press the accelerator past the point of resistance.

The transmission shifts into a lower gear.

- ▶ Ease on the accelerator when you have reached the desired speed.

The transmission shifts up again.

Stopping

When you stop briefly, e.g. at traffic lights:

- ▶ Leave the transmission in gear.
- ▶ Hold the vehicle with the brake.

When you stop longer with the engine idling and/or on a hill:

- ▶ Set the parking brake.
- ▶ Shift into park position **P**.

Maneuvering

When you maneuver in tight areas, e.g. when pulling into a parking space:

- ▶ Control the vehicle speed by gradually releasing the brakes.
- ▶ Accelerate gently.
- ▶ Never abruptly step on the accelerator.

Rocking the vehicle

Rocking the vehicle by shifting between **D** and **R** can help free a vehicle stuck in mud or snow. The engine control system of this vehicle electronically limits shifting between **D** and **R** to very low speeds (i.e. approx. 2 mph). To shift between **D** and **R**, move the gear selector lever past the resistance point up or down.

Hill start assist system

On uphill grades, the hill start assist system maintains the pressure in the brake system for approximately one second after you have released the brake pedal. Therefore, you can start off smoothly without the vehicle moving immediately after releasing the brake pedal.

The hill start assist system is inactive

- on driving downhill
- in position **N**
- with the parking brake set

Warning!



The hill start assist system is not designed to function as a parking brake and does not prevent the vehicle from moving when parked on an incline.

Always set the parking brake in addition to shifting to park position **P**.



If the ESP[®] has switched off due to a malfunction, the hill start assist system is also unavailable.

Working on the vehicle

Warning!



When working on the vehicle, set the parking brake and shift to park position **P**. Otherwise the vehicle could roll away.

Towing a trailer

If you tow a trailer, note the following points:

- Manually shift to a lower gear range (> page 187) if the transmission hunts between gears on inclines.

A lower gear range and reduction of speed reduces the chance to overload or overheat the engine.

For more information on trailer towing, see the “Operation” section (> page 314).

Controls in detail

Automatic transmission

Emergency operation (Limp Home Mode)

If vehicle acceleration worsens or the transmission no longer shifts, the transmission is most likely operating in limp home (emergency operation) mode. In this mode only second gear and reverse gear can be activated.

- ▶ Stop the vehicle.
- ▶ Shift to park position **P**.
- ▶ Turn off the engine.
- ▶ Wait at least ten seconds before restarting.
- ▶ Restart the engine.
- ▶ Shift to drive position **D** (for second gear) or reverse gear **R**.
- ▶ Have the transmission checked at an authorized Mercedes-Benz Light Truck Center as soon as possible.

▼ **Transfer case**

For more information on Off-road driving, see “Off-road driving” (> page 306).



Because of the ESP's[®] automatic operation, the engine must be shut off (SmartKey or SmartKey with KEYLESS-GO* in starter switch position **1**) when testing the brakes on a brake test dynamometer and such testing should be no longer than 10 seconds. Active braking action through the ESP[®] may otherwise seriously damage the front or rear axle brake system.

Operational or performance tests with the engine running must only be conducted on a two-axle dynamometer. Otherwise, the transfer case or the brake system can be damaged, which is not covered by the Mercedes-Benz Limited Warranty.



The vehicle is equipped with full-time four-wheel drive. Both the front and rear axles are powered at all times when the vehicle is being operated.

Controls in detail

Good visibility

For information on the windshield wipers, see “Windshield wipers” (▷ page 55).

Headlamp cleaning system*

The switch is located on the left side of the dashboard.



① Headlamp washer switch

- ▶ Switch on the ignition (▷ page 34).
- ▶ Press headlamp washer switch ①.

The headlamps are cleaned with a high-pressure water jet.

For information on filling up the washer reservoir, see “Windshield/rear window washer system and headlamp cleaning system*” (▷ page 333).

Rear view mirrors

For more information on setting the rear view mirrors, see “Mirrors” (▷ page 43).

Interior rear view mirror, antiglare position



① Lever

- ▶ Tilt the mirror to the antiglare position by moving lever ① towards the windshield.

The interior rear view mirror is dimmed.

Auto-dimming rear view mirror*

The reflection brightness of the exterior rear view mirror on the driver's side and the interior rear view mirror will respond automatically to glare when

- the ignition is switched on
- incoming light from headlamps falls on the sensor in the interior rear view mirror

The rear view mirror will not react if

- reverse gear **R** is engaged
- the interior light is turned on

Warning!



The auto-dimming function does not react if incoming light is not aimed directly at sensors in the interior rear view mirror.

The interior rear view mirror and the exterior rear view mirror on the driver's side do not react, for example, when transporting cargo which covers the rear window.

Glare can endanger you and others.

Warning!



In case of an accident, liquid electrolyte may escape from the mirror housing if the mirror glass breaks.

Electrolyte has an irritating effect. Do not allow the liquid to come into contact with eyes, skin, clothing, or respiratory system. In case it does, immediately flush affected area with water, and seek medical help if necessary.

Controls in detail

Good visibility



Electrolyte drops coming into contact with the vehicle paint finish can be completely removed only while in the liquid state and by applying plenty of water.

Warning!



Exercise care when using the passenger-side exterior rear view mirror. The mirror surface is convex (outwardly curved surface for a wider field of view). Objects in mirror are closer than they appear. Check your interior rear view mirror or glance over your shoulder before changing lanes.

Controls in detail

Good visibility

Activating exterior rear view mirror parking position*

Follow these steps to activate the mirror parking position so that the passenger-side exterior rear view mirror will be turned downward to the stored position.

The buttons are located on the door control panel.



- ① Driver's side exterior rear view mirror button
- ② Adjustment button
- ③ Passenger-side exterior rear view mirror button

- ▶ Make sure you have stored a parking position for the passenger-side exterior rear view mirror (▷ page 137).
- ▶ Make sure the Mirror adjustment parking assist function in the Convenience submenu of the control system is switched to On (▷ page 174).
- ▶ Switch on the ignition (▷ page 34).
- ▶ Place the gear selector lever in reverse gear **R**.

The indicator lamp on the driver's side or passenger-side exterior rear view mirror button comes on, dependent from the last setting.

When the driver's side exterior rear view mirror button comes on:

- ▶ Press button ③ for the passenger-side exterior rear view mirror.

The passenger-side exterior rear view mirror will be turned downward to the stored position.

When the passenger-side exterior rear view mirror button comes on:

The passenger-side exterior rear view mirror will be turned downward to the stored position.



The exterior rear view mirror parking position is key-dependent. For more information on storing exterior rear view mirror parking position, see "Storing exterior rear view mirror parking position" (▷ page 137).

The exterior rear view mirror returns to its previously stored driving position:

- when you switch off the ignition
- ten seconds after you put the gear selector lever out of position **R**
Approximately 15 seconds later the indicator lamp on the exterior rear view mirror button goes out.
- immediately once your vehicle exceeds a speed of approx. 6 mph (10 km/h)
- immediately when you press button ① for driver's side mirror (▷ page 196)



With gear selector lever in reverse gear **R** you can deactivate the exterior rear view mirror parking position by pressing button ①, or activate by pressing button ③. The indicator lamp of the selected button is on.

Power folding exterior rear view mirrors*



Before you drive the vehicle through an automatic car wash, fold the exterior mirrors in, otherwise they may get damaged.

Folding the exterior mirrors in and out automatically

When the corresponding function in the control system is activated (▷ page 175):

- The exterior rear view mirrors automatically fold in as soon as the vehicle is locked from the outside.
- The exterior rear view mirrors automatically fold out as soon as the vehicle is unlocked and the driver's or front passenger door are subsequently opened.

Controls in detail

Good visibility

Folding the exterior mirrors in and out manually

The button is located on the door control panel.



- ① Button for folding exterior mirrors in and out
- ▶ Switch on the ignition (▷ page 34).

Controls in detail

Good visibility

Folding in

- ▶ Briefly press button ①.
Both mirrors fold in.



If you are driving at more than approximately 30 mph (47 km/h), you will not be able to fold the exterior mirrors in.

Folding out

- ▶ Briefly press button ① again.
Both mirrors fold out.



If an exterior rear view mirror housing is forcibly pushed forward (hit from the rear) or forcibly pushed rearward (hit from the front) press button ① to fold mirrors in, then press button ① again to fold mirrors out. Do not force mirrors by hand as this may damage the adjustment mechanism.

The mirror housing is now properly positioned and you can adjust the mirror normally.

Sun visors

The sun visors protect you from sun glare while driving.

Warning!



Do not use the vanity mirror while driving.
Keep the mirrors in the sun visors closed while vehicle is in motion. Reflected glare can endanger you and others.

Controls in detail

Good visibility



- ① Mounting
- ② Sun visor

- ▶ Swing sun visor ② down when you experience glare.



If sunlight enters through a side window, disengage sun visor from mounting ① and pivot to the side.

Mirror lamp ③ (▷ page 199) will switch off.



- ① Mounting
- ② Additional visor*
- ③ Sun visor

If sunlight enters through a side window:

- ▶ Swing sun visor ③ down.
- ▶ Disengage sun visor ③ from mounting by pulling the visor up at an angle ①.
- ▶ Pivot sun visor ③ to the side.

The sun visors are extendable.

- ▶ Adjust the sun visors by pushing or pulling in the direction of the arrows.
- ▶ Swing additional visor* ② down when you experience glare.



- ① Sun visor
- ② Mirror cover
- ③ Mirror lamp
- ④ Vanity mirror

Controls in detail

Good visibility

- ▶ Make sure the sun visor is properly engaged in the mounting.
- ▶ Lift the mirror cover ② to access the mirror.
Mirror lamp ③ switches on.

Rear window defroster

The rear window defroster uses a large amount of power. To keep the battery drain to a minimum, switch off the defroster as soon as the rear window is clear. The defroster is automatically deactivated after approximately 6 to 17 minutes of operation depending on the outside temperature.

Warning!



Any accumulation of snow and ice should be removed from the rear window before driving. Visibility could otherwise be impaired, endangering you and others.



If the rear window defroster switches off too soon and the indicator lamp starts flashing, this means that too many electrical consumers are operating simultaneously and there is insufficient voltage in the battery. The system responds automatically by deactivating the rear window defroster.

As soon as the battery has sufficient voltage, the rear window defroster automatically turns itself back on.

Activating

- ▶ Switch on the ignition (▷ page 34).
- ▶ Press button  on the climate control panel (▷ page 204) or the automatic climate control* panel (▷ page 218).

The indicator lamp on the button comes on.

Deactivating

- ▶ Press button  again.

The indicator lamp on the button goes out.

Controls in detail
Climate control



Controls in detail

Climate control

- ① Door air vent, fixed
- ② Side air vent, adjustable
- ③ Thumbwheel for air volume control for side air vent
- ④ Thumbwheel for air volume control for left center air vent
- ⑤ Left center air vent, adjustable
- ⑥ Right center air vent, adjustable
- ⑦ Thumbwheel for air volume control for right center air vent
- ⑧ Thumbwheel for air volume control for side air vent
- ⑨ Side air vent, adjustable
- ⑩ Door air vent, fixed
- ⑪ Climate control panel

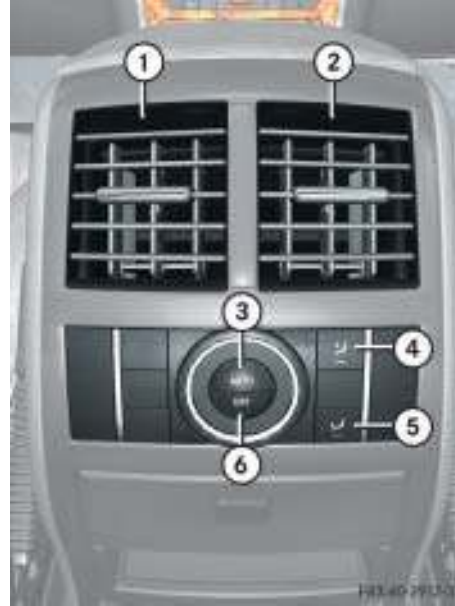

Rear climate control panel

- ① Left rear center air vent, adjustable
- ② Right rear center air vent, adjustable
- ③ Air distribution and air volume (automatic, manual)
- ④ Air distribution (directs air through the center air vents)
- ⑤ Air distribution (directs air through the footwells and both center air vents)
- ⑥ Rear air conditioning on/off



For draft-free ventilation, move the sliders for the center vents ⑤ and ⑥ to the middle position.

Controls in detail

Climate control

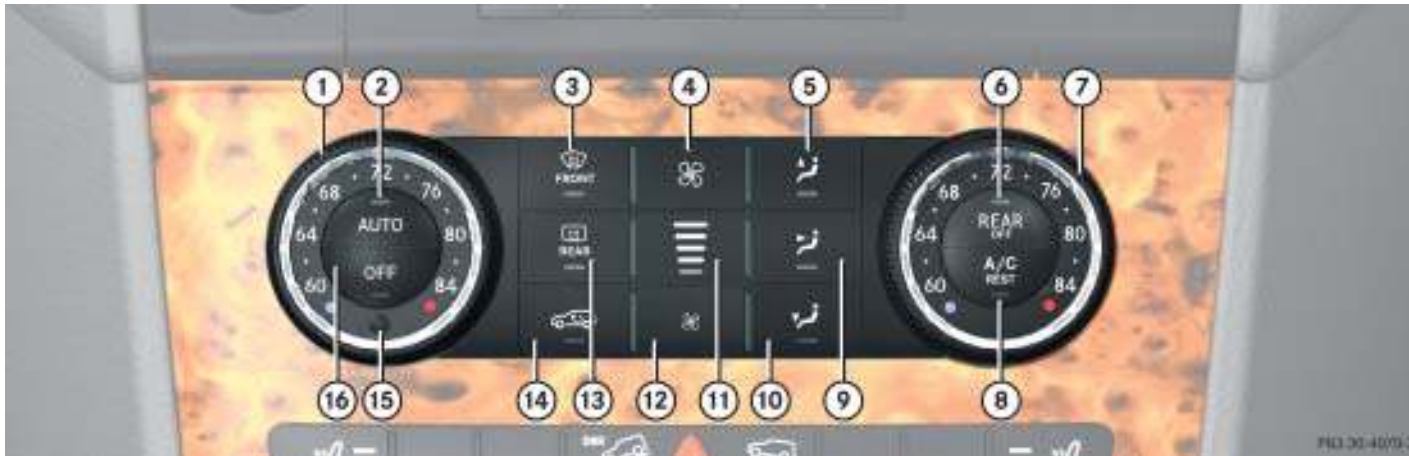

① Temperature control, left

② Air distribution and air volume (automatic, manual)

③ Defrosting

④ Increase air volume

⑤ Air distribution (directs air through the windshield and side air vents)

⑥ Rear air conditioning on/off

⑦ Temperature control, right

⑧ AC cooling on/off (**A/C**)
Residual heat/ventilation (**REST**)

⑨ Air distribution (directs air through center and side air vents)

⑩ Air distribution (directs air through the footwells and side vents)

⑪ Indicator lamps for air volume settings

⑫ Decrease air volume

⑬ Rear window defroster

⑭ Air recirculation

⑮ Interior temperature sensor

⑯ Climate control on/off

The climate control is operational whenever the engine is running. You can operate the climate control system in either the automatic or manual mode. The system cools or heats the interior depending on the selected interior temperature and the current outside temperature.

Warning!



When operating the climate control, the air that enters the passenger compartment through the air vents in the footwell can be very hot or very cold (depending on the set temperature). This may cause burns or frostbite to unprotected skin in the immediate area of the air vents. Always keep sufficient distance between unprotected parts of the body and the footwell air vents. If necessary change the air flow using the air distribution controls (▷ page 204) to direct the air away from the footwell air vents.

Nearly all dust particles, pollutants and odors are filtered out before outside air enters the passenger compartment through the air distribution system.

The air conditioning will not engage (no cooling) if the **A/C** mode is deactivated (▷ page 211).

Warning!



Follow the recommended settings for heating and cooling given on the following pages. Otherwise the windows could fog up, impairing visibility and endangering you and others.

Controls in detail

Climate control



Severe conditions (e.g. strong air pollution) may require replacement of the filter before its scheduled interval. A clogged filter will reduce the air volume to the interior.

If the vehicle interior is hot, ventilate the interior before driving off.

Keep the air intake grille in front of the windshield free of snow and debris.

Controls in detail

Climate control

Deactivating the climate control system

Deactivating

- ▶ Press button **OFF** (▷ page 204).



When the air conditioning is switched off, the outside air supply and circulation are also switched off. Only choose this settings for a short time. Otherwise the windows could fog up.

Reactivating

- ▶ Press button **AUTO** (▷ page 204).



You can also press button **OFF** on the climate control panel.

If you press button **FRONT** to reactivate the climate control system, the defrosting mode is activated.

Rear air conditioning

You can switch on and off the rear air conditioning using the climate control panel in the front.

Deactivating

- ▶ Press button **REAR OFF** on the front climate control panel (▷ page 204).

The indicator lamp on button **REAR OFF** comes on. The rear air conditioning is switched off.

Activating

- ▶ Press button **REAR ON** on the front climate control panel (▷ page 204).

The indicator lamp on button **REAR ON** goes out. The rear air conditioning is adjusted automatically.



You can also switch on and off the rear air conditioning by pressing the respective button on the rear climate control panel.

For more information on rear air conditioning, see “Rear air conditioning” (▷ page 213).

Controls in detail

Climate control

Setting the temperature

Use temperature controls ① and ⑦ (> page 204) to separately adjust the air temperature on each side of the passenger compartment. You should raise or lower the temperature setting in small increments, preferably starting at 72°F (22°C). The climate control will adjust to the set temperature as fast as possible.

Increasing

- ▶ Turn the temperature control ① and/or ⑦ slightly to the right.

The climate control system will correspondingly adjust the interior air temperature.

Decreasing



- ▶ Turn the temperature control ① and/or ⑦ slightly to the left.

The climate control system will correspondingly adjust the interior air temperature.

Adjusting air distribution

Use air distribution control ⑤, ⑨, or ⑩ (> page 204) to adjust the air distribution.

The following symbols are found on the controls:

Symbol	Function
	Directs air to the windshield and side air vents
	Directs air through the center and side air vents
	Directs air to the footwells and side air vents

Adjusting manually

- ▶ Press the desired air distribution control.

The indicator lamp on the button **AUTO** goes out.

Controls in detail

Climate control

Adjusting automatically

- ▶ Press button **AUTO** (▷ page 204).
The indicator lamp on button **AUTO** comes on. The air distribution is adjusted automatically.



Windshield fogged on the outside

- ▶ Switch the windshield wipers on (▷ page 55).
- ▶ Press the button **AUTO**.
The indicator lamp on button **AUTO** comes on.

Adjusting air volume

Adjusting manually

Five blower speeds are available.

- ▶ Press  to decrease or  to increase air volume to the desired level.
The indicator lamp on button **AUTO** goes out. The selected blower speed is shown by the indicator lamps for air volume settings (▷ page 204).

Adjusting automatically

- ▶ Press button **AUTO**.
The indicator lamp on button **AUTO** comes on. The air volume is adjusted automatically.

Defrosting

If the air volume is switched off or the air recirculation mode is switched on, the interior is no longer ventilated and the windows can get fogged on the inside.



These settings should only be selected for a short time.

Activating

- ▶ Press button  (▷ page 204).
The yellow indicator lamp on the button comes on.
The air conditioning switches automatically to the following functions:
 - maximum blower and heating power
 - air flows onto the windshield and the front side windows (side air vents must be open)

- The climatic compressor is switched on at outside temperatures above approximately 41°F (5°C) for air-drying

Deactivating

- ▶ Press button .

The yellow indicator lamp on the button goes out. Defrosting is turned off.



To switch off, you can press also button **OFF** or **AUTO**.

Air recirculation mode

Switch to air recirculation mode to prevent unpleasant odors from entering the vehicle from the outside (e.g. before a tunnel travel). This setting cuts off the intake of outside air and recirculates the air in the passenger compartment.

Warning!



Fogged windows impair visibility, endangering you and others. If the windows begin to fog on the inside, switching off the air recirculation mode immediately should clear interior window fogging. If interior window fogging persists, make sure the air conditioning (> page 204) is activated, or press button .

Controls in detail



Climate control

Activating

- ▶ Press button .

The indicator lamp on the button comes on.



Press and hold button  for approx. two seconds. The side windows and tilt/sliding sunroof* will close. You can release button  once the closing procedure has begun. The windows and tilt/sliding sunroof* continue closing until they are fully closed.

Controls in detail

Climate control

Warning!



Never operate the windows and tilt/sliding sunroof* if there is the possibility of anyone being harmed by the opening or closing procedure.

In the event that the closing procedure causes potential danger, the closing of the side windows can be immediately halted by pressing or pulling the respective window switch. The procedure for the tilt/sliding sunroof can be immediately halted by moving the switch for the tilt/sliding sunroof in any direction.

The closing of the side windows and the tilt/sliding sunroof can be reversed by again pressing and holding the  button.



The air recirculation mode is activated automatically at high outside temperatures.

After 30 minutes at the latest, outside air is added.

If you have turned off the air conditioning (▷ page 211) or the outside temperature is below 41°F (5°C), the air recirculation mode will not switch on automatically.





To achieve the fastest possible cooling of the interior, the climate control automatically switches to air recirculation. The indicator lamp in the button  is not illuminated when the system automatically switches to air recirculation.



Deactivating

- ▶ Press button .

The indicator lamp on the button goes out.



Press and hold button  for approx. two seconds. You can release button  once the opening procedure has begun. The windows and tilt/sliding sunroof* continue opening until they have reached their previous position.

A window or tilt/sliding sunroof* will only return to its previous position if it has not been moved to another position using the respective window switch or tilt/sliding sunroof* switch after it was closed with button . A window or tilt/sliding sunroof* that was moved will remain in its current position if button  is used to re-open the remaining windows or tilt/sliding sunroof*.

Controls in detail

Climate control



The air recirculation mode is deactivated automatically

- after five minutes if the outside temperature is below approximately 41°F (5°C)
- after five minutes if the air conditioning and air-drying is turned off
- after 30 minutes if the outside temperature is above approximately 41°F (5°C)

At outside temperatures above 79°F (26°C), the system will not automatically switch back to outside air. A quantity of outside air is added after approximately 30 minutes.

Air conditioning

The air conditioning is operational while the engine is running and cools the interior air to the temperature set by the operator. In addition, the air conditioning dehumidifies the interior air at outside temperatures above 41°F (5°C) and helps prevent window fogging.



Condensation may drip out from underneath the vehicle. This is normal and not an indication of a malfunction.

Warning!



If you turn off the cooling function, the interior air is not dried. The windows can fog up more quickly. Window fogging may impair visibility and endanger you and others.

Deactivating

It is possible to deactivate the air conditioning (cooling) function of the climate control system. The air in the vehicle will then no longer be cooled or dehumidified.

- Press button  (▷ page 204).

The indicator lamp on the button  goes out.

Controls in detail

Climate control

Activating

Moist air can fog up the windows. You can dehumidify the air with the air conditioning.

- ▶ Press button **A/C** again.

The indicator lamp on button **A/C** comes on.

The air conditioning uses the refrigerant R134a. This refrigerant is free of CFCs which are harmful to the ozone layer.



If the air conditioning cannot be turned on again, this indicates that the air conditioning is losing refrigerant. The compressor has turned itself off.

Have the air conditioning checked at the nearest authorized Mercedes-Benz Light Truck Center.

Residual heat and ventilation

With the engine switched off, it is possible to continue to heat or ventilate the interior for up to 30 minutes. This feature makes use of the residual heat produced by the engine.



How long the system will provide heating depends on the coolant temperature and the battery voltage. Regardless of the temperature and air volume set on the climate control panel an interior temperature is aimed at by 72°F (22°C) and the blower runs for the protection of the battery on low stage.

Activating

- ▶ Turn the SmartKey in the starter switch to position **0** or **1**, or remove it from the starter switch.

- ▶ Press button **REST** (▷ page 204).

The indicator lamp on button **REST** comes on.

Deactivating

- ▶ Press button **REST** (▷ page 204).

The indicator lamp on button **REST** goes out.

Controls in detail

Climate control



The residual heat is automatically turned off:

- when the ignition is switched on
- after about 30 minutes
- if the coolant temperature is too low
- if the battery voltage drops

Rear air conditioning

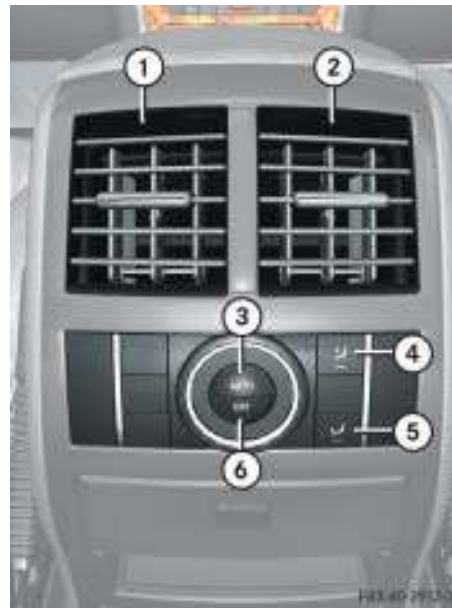

Rear climate control panel

- ① Left rear center air vent, adjustable
- ② Right rear center air vent, adjustable
- ③ Air distribution and air volume (automatic, manual)
- ④ Directs air through the center air vents
- ⑤ Directs air through the footwells and both center air vents
- ⑥ Rear air conditioning on/off

Activating rear air conditioning

- ▶ Press button **AUTO**.

The indicator lamp on button **AUTO** comes on. The temperature, air volume and air distribution are adjusted automatically.

Controls in detail

Climate control

Deactivating rear air conditioning

For an improved cooling or heating output in the front passenger compartment, you can switch off the rear passenger compartment ventilation.

- ▶ Press button **OFF**.



The indicator lamp on button **OFF** goes out.

The cooling function switches off after a short delay.

Adjusting air distribution

Use the air distribution controls ④ or ⑤ to adjust the air distribution for the rear passenger compartment.

The following symbols are found on the controls:

Symbol	Function
	Directs air to the center air vents
	Directs air to the footwells and the side air vents

Adjusting manually

- ▶ Press the desired air distribution control.

The indicator lamp in the **AUTO** button goes out.

Adjusting automatically

- ▶ Press button **AUTO** (▷ page 213).

The indicator lamp in the **AUTO** button illuminates. The air distribution is adjusted automatically.

Adjusting air volume

The air volume for the rear zone corresponds to the air volume settings for front zone. You can switch off the air supply for the rear zone.

You can switch off the supplied amount of air volume.

- ▶ Press button **OFF** (▷ page 213).

Controls in detail

3-zone automatic climate control*



Controls in detail

3-zone automatic climate control*

- ① Door air vent, fixed
- ② Side air vent, adjustable
- ③ Thumbwheel for air volume control for side air vent
- ④ Thumbwheel for air volume control for left center air vent
- ⑤ Left center air vent, adjustable
- ⑥ Right center air vent, adjustable
- ⑦ Thumbwheel for air volume control for right center air vent
- ⑧ Thumbwheel for air volume control for side air vent
- ⑨ Side air vent, adjustable
- ⑩ Door air vent, fixed
- ⑪ Climate control panel

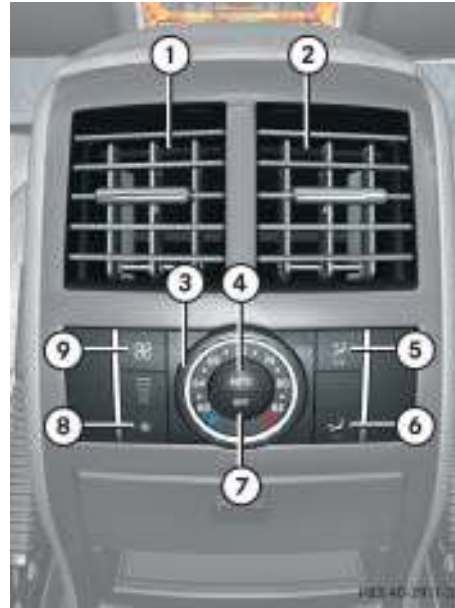

Rear automatic climate control panel

- ① Left rear center air vent, adjustable
- ② Right rear center air vent, adjustable
- ③ Temperature control
- ④ Air distribution and air volume (automatic, manual)
- ⑤ Air distribution (directs air through the side air vents)
- ⑥ Air distribution (directs air through the footwells and both center air vents)
- ⑦ Rear air condition on/off
- ⑧ Decrease air volume
- ⑨ Increase air volume



For draft-free ventilation, move the sliders for the center vents ⑤ and ⑥ to the middle position.

Controls in detail

3-zone automatic climate control*



① Temperature control, left

② Air distribution and air volume (automatic, manual)

③ Left side air distribution

④ Defrosting

⑤ Increase air volume

⑥ Rear window defroster

⑦ Right side air distribution

⑧ Rear air conditioning

⑨ Temperature control, right

⑩ Automatic climate control on/off

⑪ Right side air distribution

⑫ Right side air distribution

⑬ AC cooling on/off (**A/C**)
Residual heat/ventilation (**REST**)

⑭ Display

⑮ Decrease air volume

⑯ Air recirculation

⑰ Left side air distribution

⑱ Left side air distribution

⑲ Interior temperature sensor

⑳ Adopt driver zone settings in other zones

Controls in detail

3-zone automatic climate control*

Warning!



When operating the climate control, the air that enters the passenger compartment through the air vents in the footwell can be very hot or very cold (depending on the set temperature). This may cause burns or frostbite on unprotected skin in the immediate area of the air vents.

Always keep sufficient distance between unprotected parts of the body and the footwell air vents. If necessary, change the air flow using the air distribution controls (> page 218) to direct the air away from the footwell air vents.

The climate control is a 3-zone intelligent climate control system. Your vehicle interior is divided into 3 zones.

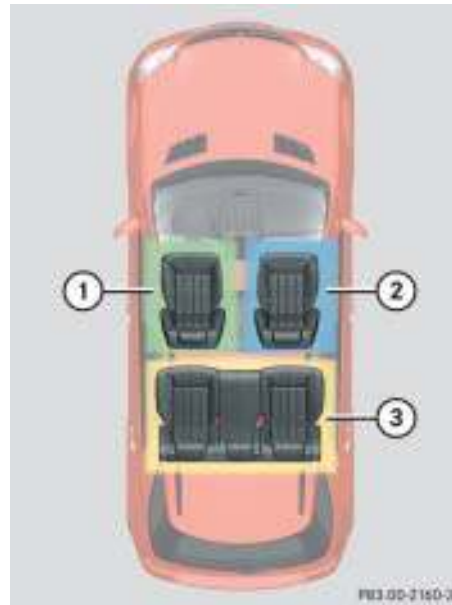

With the help of a sun sensor, the climate control determines the relation of the sun to the vehicle and automatically adjusts the inside temperature for every individual zone.

The climate control is operational whenever the engine is running. It cools the vehicle's interior according to the angle and intensity of the sun's rays, the outside temperature and the selected temperature. You can operate the automatic climate control in either the automatic or manual mode.

Controls in detail

3-zone automatic climate control*

Nearly all dust particles, pollutants and odors are filtered out before outside air enters the passenger compartment through the air distribution system.

The air conditioning will not engage (no cooling) if the **A/C** mode is deactivated (▷ page 218).

Warning!



Follow the recommended settings for heating and cooling given on the following pages. Otherwise the windows could fog up, impairing visibility and endangering you and others.



Severe conditions (e.g. strong air pollution) may require replacement of the filter before its scheduled interval. A clogged filter will reduce the air volume to the interior.

If the vehicle interior is hot, ventilate the interior before driving off.

Keep the air intake grille in front of the windshield free of snow and debris.

Deactivating the climate control system

Deactivating

- ▶ Press button **OFF** (▷ page 218).



When the air conditioning is switched off, the outside air supply and circulation are also switched off. Only choose this settings for a short time. Otherwise the windows could fog up.

Reactivating

- ▶ Press button **AUTO** (▷ page 218).



You can also press button **OFF** on the climate control panel.

If you press button  to reactivate the climate control system, the defrosting mode is activated.

3-zone automatic climate control*

Rear air conditioning

You can switch on and off the rear air conditioning with the climate control panel in the front.



For information on operating the rear climate control panel from the rear seats, see “Rear air conditioning” (▷ page 227).

Deactivating

- ▶ Press button **REAR** on the climate control panel (▷ page 218).

The indicator lamp on button **REAR** comes on. The rear air conditioning is switched off. **REAR OFF** appears in the climate control display.

Activating

- ▶ Press button **REAR** on the climate control panel (▷ page 218).

The indicator lamp on button **REAR** goes out. The rear air conditioning is adjusted automatically. **REAR ON** appears in the climate control display.



You can switch on and off the rear air conditioning by pressing the respective button on the rear climate control panel.

For more information on rear air conditioning, see “Rear air conditioning” (▷ page 227).

Setting the temperature

Use temperature control ① and ② (▷ page 218) to separately adjust the air temperature on each side of the passenger compartment. You should raise or lower the temperature setting in small increments, preferably starting at 72°F (22°C). The climate control will adjust to the set temperature as fast as possible.

Increasing

- ▶ Turn the temperature control ① and/or ② slightly to the right.

The climate control system will correspondingly adjust the interior air temperature.

Decreasing

- ▶ Turn the temperature control ① and/or ② slightly to the left.

The climate control system will correspondingly adjust the interior air temperature.



Controls in detail

3-zone automatic climate control*

Adjusting air distribution

Use the air distribution controls ③, ⑰, or ⑱ for the left side, or ⑦, ⑪, or ⑫ (▷ page 218) for the right side to separately adjust the air distribution on each side of the passenger compartment.

The following symbols are found on the controls:

Symbol	Function
	Directs air to the windshield and side air vents
	Directs air through the center, side and rear passenger compartment air vents
	Directs air to the footwells and side air vents

Adjusting manually

- ▶ Press the desired air distribution control.

The indicator lamp on button **AUTO** goes out.

Adjusting automatically

- ▶ Press button **AUTO** (▷ page 218).

The indicator lamp on button **AUTO** comes on. The air distribution is adjusted automatically.

Windshield fogged on the outside

- ▶ Switch the windshield wipers on (▷ page 55).



- ▶ Press button **AUTO**.

The indicator lamp on the button comes on.

Adjusting air volume

Adjusting manually

Five blower speeds are available.

- ▶ Press  to decrease or  to increase air volume to the desired level (▷ page 218).

The indicator lamp on button **AUTO** goes out. The selected blower speed is shown in the display.

Adjusting automatically

- ▶ Press button **AUTO**.

The indicator lamp on button **AUTO** comes on. The air volume is adjusted automatically.

Controls in detail

3-zone automatic climate control*

Maximum cooling MAX COOL

If the air distribution control as well as the airflow volume control are set to **AUTO** and there is a high need for cooling, the display “MAX COOL” appears in the front and rear display.

This provides the fastest possible cooling of the vehicle interior (when windows and tilt/sliding sunroof* are closed).

Defrosting

If the air volume is switched off or the air recirculation mode is switched on, the interior is not any longer ventilated and the windows can get fogged on the inside.



These settings should only be selected for a short time.

When the defrost setting has been selected, only the rear window defroster can be switched on. No other settings are possible.

Activating

► Press button  (▷ page 218).

The indicator lamp on button  comes on.

The climate control switches automatically to the following functions:

- maximum blower and heating power
- air flows onto the windshield and the front side windows (side air vents must be open)
- The climatic compressor is switched on at outside temperatures above approximately 41°F (5°C) for air-drying

Deactivating

► Press button .

The yellow indicator lamp on the button goes out. Defrosting is turned off.



To switch off you can press also the button **OFF** or **AUTO**.

Air recirculation mode

Switch to air recirculation mode to prevent unpleasant odors from entering the vehicle from the outside (e.g. before a tunnel travel). This setting cuts off the intake of outside air and recirculates the air in the passenger compartment.

Warning!



Fogged windows impair visibility, endangering you and others. If the windows begin to fog on the inside, switching off the air recirculation mode immediately should clear interior window fogging. If interior window fogging persists, make sure the air conditioning (▷ page 225) is activated, or press button .

Controls in detail



3-zone automatic climate control*

Activating

- ▶ Press button  (▷ page 218).

The indicator lamp on the button  comes on.



Press and hold button  for approx. two seconds. The side windows and tilt/sliding sunroof* will close. You can release button  once the closing procedure has begun. The windows and tilt/sliding sunroof* continue closing until they are fully closed.

Warning!



Never operate the side windows and tilt/sliding sunroof* if there is the possibility of anyone being harmed by the opening or closing procedure.

In the event that the closing procedure causes potential danger, the closing of the side windows can be immediately halted by pressing or pulling the respective window switch. The closing of the tilt/sliding sunroof* can be immediately halted by moving the tilt/sliding sunroof* switch in the overhead control panel in any direction.

The closing of the side windows and the tilt/sliding sunroof* can be reversed by again pressing and holding the  button.



The air recirculation mode is activated automatically at high outside temperatures.

If you have turned off the air conditioning (▷ page 225) or the outside temperature is below 41°F (5°C), the air recirculation mode will not switch on automatically.





To achieve the fastest possible cooling of the interior, the automatic climate control automatically switches to air recirculation. The indicator lamp in the button  is not illuminated when the system automatically switches to air recirculation.



Controls in detail



3-zone automatic climate control*

Deactivating

- ▶ Press button  (▷ page 218).
The indicator lamp on button  goes out.



Press and hold button  for approx. two seconds. You can release button  once the opening procedure has begun. The windows and tilt/sliding sunroof* continue opening until they have reached their previous position.

A window or tilt/sliding sunroof* will only return to its previous position if it has not been moved to another position using the respective window switch or tilt/sliding sunroof* switch after it was closed with button . A window or tilt/sliding sunroof* that was moved will remain in its current position if button  is used to re-open the remaining windows or tilt/sliding sunroof*.



The air recirculation mode is deactivated automatically

- after five minutes if the outside temperature is below approximately 41°F (5°C)
- after five minutes if the air conditioning and air-drying is turned off
- after 30 minutes if the outside temperature is above approximately 41°F (5°C)

At outside temperatures above 79°F (26°C) the system will not automatically switch back to outside air. A quantity of outside air is added after approximately 30 minutes.

Air conditioning

The air conditioning is operational while the engine is running and cools the interior air to the temperature set by the operator. In addition the air conditioning dehumidifies the interior air at outside temperatures above than 41°F (5°C) and helps prevent window fogging.



Condensation may drip out from underneath the vehicle. This is normal and not an indication of a malfunction.

Warning!



If you turn off the cooling function, the interior air is not dried. The windows can fog up more quickly. Window fogging may impair visibility and endanger you and others.

Controls in detail

3-zone automatic climate control*

Deactivating

It is possible to deactivate the air conditioning (cooling) function of the automatic climate control system. The air in the vehicle will then no longer be cooled or dehumidified.

- ▶ Press button  (▷ page 218).

The indicator lamp on button  goes out.

The cooling function switches off after a short delay.

Activating

Moist air can fog up the windows. You can dehumidify the air with the air conditioning.

- ▶ Press button  again.

The indicator lamp on button  comes on.

The air conditioning system uses the refrigerant R-134a. This refrigerant is free of CFCs which are harmful to the ozone layer.



If the air conditioning cannot be turned on again, this indicates that the air conditioning is losing refrigerant. The compressor has turned itself off.

Have the air conditioning checked at the nearest authorized Mercedes-Benz Light Truck Center.

Residual heat and ventilation

With the engine switched off, it is possible to continue to heat or ventilate the interior for up to 30 minutes. This feature makes use of the residual heat produced by the engine.



How long the system will provide heating depends on the coolant temperature and the battery voltage. Regardless of the temperature and air volume set on the climate control panel an interior temperature is aimed at by 72°F (22°C) and the blower runs for the protection of the battery on low stage.

Controls in detail

3-zone automatic climate control*

Activating

- ▶ Turn the SmartKey in the starter switch to position **0** or **1** (▷ page 34), or remove it from the starter switch.
- ▶ Press button **REST** (▷ page 218).
The indicator lamp on button **REST** comes on.

Deactivating

- ▶ Press button **REST**.
The indicator lamp on button **REST** goes out.



The residual heat is automatically turned off:

- when the ignition is switched on
- after about 30 minutes
- if the coolant temperature is too low
- if the battery voltage drops

Rear air conditioning

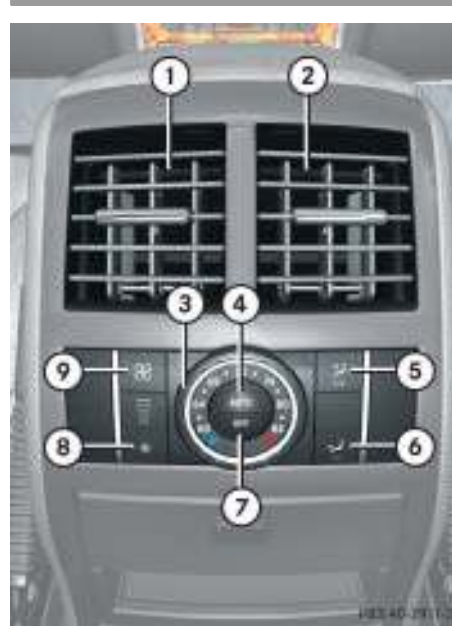

- ① Left rear center air vent, adjustable
- ② Right rear center air vent, adjustable
- ③ Temperature control
- ④ Air distribution and air volume (automatic, manual)
- ⑤ Air distribution (directs air through both center air vents)
- ⑥ Air distribution (directs air through the footwells and side air vents)
- ⑦ Rear air conditioning on/off
- ⑧ Decrease air volume
- ⑨ Increase air volume

Activating rear air conditioning

- ▶ Press button **AUTO**.
The indicator lamp on button **AUTO** comes on. The temperature, air volume and air distribution are adjusted automatically.

Controls in detail

3-zone automatic climate control*

Deactivating rear air conditioning

For an improved cooling or heating output in the front passenger compartment, the rear passenger compartment can be switched off.

For information on switching on and off the rear air conditioning from the climate control panel in the front, see “Rear air conditioning” (▷ page 218).

- ▶ Press button **OFF**.



The indicator lamp on button **OFF** goes out.

The cooling function switches off after a short delay.

Adjusting air distribution

Use the air distribution controls ⑤ or ⑥ to adjust the air distribution for the rear passenger compartment.

The following symbols are found on the controls:

Symbol	Function
	Directs air to the center air vents
	Directs air to the footwells and the side air vents

Adjusting manually

- ▶ Press the desired air distribution control.

The indicator lamp in the **AUTO** button goes out.

Adjusting automatically

- ▶ Press button **AUTO** ④.

The indicator lamp in the **AUTO** button illuminates. The air distribution is adjusted automatically.

Setting the temperature

Use temperature control ③ to separately adjust the air temperature of the rear passenger compartment. You should raise or lower the temperature setting in small increments, preferably starting at 72°F (22°C).





The rear air conditioning will not cool the air when **A/C** mode has been selected on the front control panel.

Increasing/decreasing the temperature

- ▶ Turn the temperature control ③ slightly left or right until the desired temperature is selected.

The rear air conditioning will correspondingly adjust the interior air temperature for the rear passenger compartment.

Adjusting air volume

- ▶ Press  to decrease or  to increase air volume to the desired level.

Controls in detail

Power windows

Opening and closing the windows

The side windows are opened and closed electrically. The switches for all of the side windows are on the driver's door. The switches for the respective windows are on the front passenger door and the rear doors.



- ① Left rear window
 - ② Left front window
 - ③ Right front window
 - ④ Right rear window
 - ⑤ Rear window override switch
- (▷ page 89)



Warning!



When closing the windows, make sure that there is no danger of anyone being harmed by the closing procedure.

The closing of the door windows can be immediately halted by releasing the switch or, if switch was pulled past the resistance point and released, by either pressing or pulling the respective switch.

The door windows are equipped with the express-close and automatic reversal function. If the window encounters an obstruction that blocks its path in a circumstance where you pulled the switch past the resistance point and released it to close the window, the automatic reversal function will stop the window and open it slightly.

If the window encounters an obstruction that blocks its path in a circumstance where you are closing the window by pulling and holding the switch, by pressing and holding button  on the SmartKey, by pressing and holding the lock button (vehicles with KEYLESS-GO*) on a door handle, or by pressing and holding button  on the climate control panel, the automatic reversal function will not operate.

When leaving the vehicle, always remove the SmartKey or SmartKey with KEYLESS-GO* from the starter switch, take it with you, and lock the vehicle. Do not leave children unattended in the vehicle, or with access to an unlocked vehicle. Unsupervised use of vehicle equipment can cause an accident and/or serious personal injury.

Controls in detail

Power windows



You can also open or close the windows using the SmartKey, see “Summer opening feature” (▷ page 233) and see “Convenience closing feature” (▷ page 234).

You can close and reopen the windows using the air recirculation button  in the control panel of the climate control (▷ page 204) or (▷ page 218).



Opening the windows from the rear is not possible if you activate the override switch (▷ page 89).



With the SmartKey in starter switch position **0** or removed from the starter switch, the power windows can be operated:

- until you open the driver’s or front passenger door
- for at least five minutes.

▶ Switch on the ignition (▷ page 34).

Opening the windows

▶ Press switch ① to ④ to the resistance point.

The corresponding window will move downwards until you release the switch.

Closing the windows

▶ Pull switch ① to ④ to the resistance point.

The corresponding window will move upwards until you release the switch.

Warning!



If you pull and hold the switch up when closing the window, and upward movement of the window is blocked by some obstruction including but not limited to arms, hands, fingers, etc., the automatic reversal will not operate.

Controls in detail

Power windows

Fully opening the windows (Express-open)

- ▶ Press switch ① to ④ past the resistance point and release.

The corresponding window opens completely.

Fully closing the windows (Express-close)

- ▶ Pull switch ① to ④ past the resistance point and release.

The corresponding window closes completely.

Warning!



Driver's door only:

If within five seconds switch is again pulled past the resistance point and released, the automatic reversal will not operate.



If the upward movement of the window is blocked during the closing procedure, the window will stop and open slightly.

Remove the obstruction, pull the respective power window switch again past the resistance point and release.

If the window still does not close when there is no obstruction, then pull and hold the respective power window switch. The side window will then close without the obstruction sensor function.

Stopping windows during Express-operation

- ▶ Press or pull respective power window switch again.

Synchronizing power windows

The power window must be resynchronized each time

- after the battery has been disconnected
- if the power windows cannot be fully opened (Express-open) or closed (Express-close)

Synchronizing

- ▶ Close all doors.
- ▶ Switch on the ignition (▷ page 34).
- ▶ Pull and hold the power window switches ① to ④ until the side windows are completely closed.

With the side windows completely closed, hold the switches for approximately three seconds.

The power windows are synchronized.



Summer opening feature

If the weather is warm, you can ventilate the vehicle before driving off by simultaneously:

- opening the side windows
- opening the tilt/sliding sunroof*



- ▶ Aim transmitter eye of the SmartKey or SmartKey with KEYLESS-GO* at the driver's door handle. The SmartKey or SmartKey with KEYLESS-GO* must be in close proximity to the driver's door handle.



- ▶ Press and hold button  until the windows and the tilt/sliding sunroof* have reached the desired position.
- ▶ Release button  to interrupt procedure.

Controls in detail

Power windows

Convenience closing feature

When you lock the vehicle, you can close the windows and tilt/sliding sunroof* simultaneously.

- ▶ Aim transmitter eye of the SmartKey or SmartKey with KEYLESS-GO* at the driver's outside door handle (▷ page 233). The SmartKey or SmartKey with KEYLESS-GO* must be in close proximity to the driver's door handle.
- ▶ Press and hold button  until the windows and tilt/sliding sunroof* are completely closed.
- ▶ Release button  to interrupt procedure.

Vehicles with KEYLESS-GO*:



- ▶ Press and hold the lock button on an outside door handle (▷ page 64) until the side windows and the tilt/sliding sunroof* are completely closed.
- ▶ Release the lock button at the outside door handle to interrupt procedure.

Warning!



When closing the windows and the tilt/sliding sunroof*, make sure that there is no danger of anyone being harmed by the closing procedure.

If potential danger exists, proceed as follows:

- Release button  to stop the closing procedure. To open, press and hold button . To continue the closing procedure after making sure that there is no danger of anyone being harmed by the closing procedure, press and hold button .

Vehicles with KEYLESS-GO*:

- Release the lock button (▷ page 64) on exterior driver's door handle to stop the closing procedure.
- Pull on the exterior driver's door handle and hold firmly. The side windows and the tilt/sliding sunroof* will open for as long as the door handle is held but the door not opened.

▼ Power tilt/sliding sunroof*

Opening and closing the power tilt/sliding sunroof

The tilt/sliding sunroof is opened and closed electrically. The switch for the tilt/sliding sunroof is on the overhead control panel.



Sunroof switch

- ① Push back to slide sunroof open
- ② Push forward to slide sunroof closed
- ③ Push up to raise sunroof at rear
- ④ Pull down to lower sunroof at rear

Controls in detail

Power tilt/sliding sunroof*

With the sunroof closed or tilted open, a screen can be slid into the roof opening to guard against sun rays. When sliding the sunroof open, the screen will also retract.



Controls in detail

Power tilt/sliding sunroof*

Warning!



When closing the tilt/sliding sunroof, make sure that there is no danger of anyone being harmed by the closing procedure.

The opening/closing procedure of the tilt/sliding sunroof can be immediately halted by releasing the switch or, if the switch was moved past the resistance point and released, by moving the switch in any direction.

The tilt/sliding sunroof is made out of glass. In the event of an accident, the glass may shatter. This may result in an opening in the roof.

In a vehicle rollover, occupants not wearing their seat belts or not wearing them properly may be thrown out of the opening. Such an opening also presents a potential for injury for occupants wearing their seat belts properly as entire body parts or portions of them may protrude from the passenger compartment.

When leaving the vehicle, always remove the SmartKey or SmartKey with KEYLESS-GO* from the starter switch, take it with you, and lock your vehicle. Do not leave children unattended in the vehicle, or with access to an unlocked vehicle. Unsupervised use of vehicle equipment can cause an accident and/or serious personal injury.



To avoid damaging the seals, do not transport any objects with sharp edges which can stick out of the tilt/sliding sunroof.

Do not open the tilt/sliding sunroof if there is snow or ice on the roof, as this could result in malfunctions.

The tilt/sliding sunroof can be opened or closed manually should an electrical malfunction occur (▷ page 439).



You can also open or close the tilt/sliding sunroof using the SmartKey, see “Summer opening feature” (▷ page 233) and see “Convenience closing feature” (▷ page 234).

You can close and reopen the tilt/sliding sunroof using the air recirculation button  in the control panel of the climate control (▷ page 204) or (▷ page 218).

- ▶ Switch on the ignition (▷ page 34).

Controls in detail

Power tilt/sliding sunroof*

Opening and closing the power tilt/sliding sunroof

- ▶ To open, close, raise, or lower the tilt/sliding sunroof, move the sunroof switch to the resistance point in the required direction of arrows ① to ④.

Release the sunroof switch when the tilt/sliding sunroof has reached the desired position.

Fully opening (Express-open) and closing (Express-close) the power tilt/sliding sunroof

- ▶ To open or close the tilt/sliding sunroof, move the sunroof switch past the resistance point in the direction of arrow ① to ② and release.
The tilt/sliding sunroof opens or closes completely.

Stopping the power tilt/sliding sunroof during Express-open

- ▶ Move the sunroof switch in any direction.
The movement of the tilt/sliding sunroof stops.



If the movement of the tilt/sliding sunroof is blocked during the closing procedure, the tilt/sliding sunroof will stop and reopen slightly.

Synchronizing the power tilt/sliding sunroof

The tilt/sliding sunroof must be synchronized each time

- after the battery has been disconnected or discharged
- after the tilt/sliding sunroof has been closed manually (▷ page 439)
- after a malfunction

- the tilt/sliding sunroof does not open smoothly
- ▶ Switch on the ignition (▷ page 34).
- ▶ Press and hold the sunroof switch in the direction of arrow ① (▷ page 235) until the tilt/sliding sunroof is fully raised at the rear.
Keep holding the sunroof switch in the direction of arrow ① for approximately one second.
- ▶ Check the Express-open feature (▷ page 237).

If the tilt/sliding sunroof opens completely, the tilt/sliding sunroof is synchronized. Otherwise repeat the above steps.

Controls in detail

Driving systems

The driving systems of your vehicle are described on the following pages:

- Cruise control, with which the vehicle can maintain a preset speed.
- Downhill Speed Regulation (DSR), which supports you when you are driving downhill.
- Off-road driving program, which supports you when you are driving off-road.
- Air suspension package* which adjusts the vehicle suspension characteristics automatically and controls the vehicle level.
- Parktronic*, which serves as a parking aid.

For information on the ABS, BAS, EBB, ESP®, and 4-ETS driving systems, see “Driving safety systems” (▷ page 93).

Cruise control

The cruise control automatically maintains the speed you set for your vehicle.

Use of cruise control is recommended for driving at a constant speed for extended periods of time. You can set or resume cruise control at any speed above 20 mph (30 km/h).

The cruise control function is operated by means of the cruise control lever.

The cruise control lever is the uppermost lever on the left-hand side of the steering column (▷ page 22).



The cruise control should not be activated during off-road driving.

Warning!



The cruise control is a convenience system designed to assist the driver during vehicle operation. The driver is and must remain at all times responsible for the vehicle speed and for safe brake operation.

Only use the cruise control if the road, traffic, and weather conditions make it advisable to travel at a steady speed.

- The use of cruise control can be dangerous on winding roads or in heavy traffic because conditions do not allow safe driving at a steady speed.
- The use of cruise control can be dangerous on slippery roads. Rapid changes in tire traction can result in wheel spin and loss of control.
- Deactivate the cruise control when driving in fog.

The “Resume” function should only be operated if the driver is fully aware of the previously set speed and wishes to resume this particular preset speed.

Controls in detail

Driving systems

Warning!



The cruise control brakes automatically so that the set speed is not exceeded. The brake pedal depresses when the cruise control engages the brakes.

Keep driver's foot area clear at all times, including the area under the brake pedal. Objects stored in this area may impair pedal movement which could interfere with the braking ability of the cruise control system.

Do not place your foot under the brake pedal - your foot could become caught.

Keep in mind that the cruise control is a convenience system designed to assist the driver during vehicle operation. The driver is and must always remain responsible for the vehicle's speed and for safe brake operation.

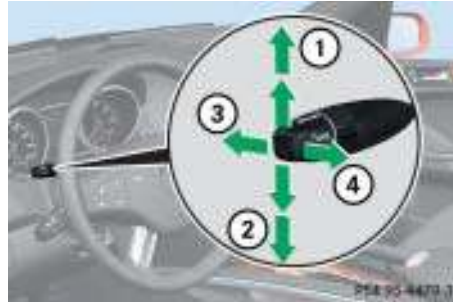

- ① Set current or higher speed
Adjustment in 1 mph increments (first position) or 5 mph increments (second position) (Canada: 1 km/h or 10 km/h)
- ② Set current or lower speed
Adjustment in 1 mph increments (first position) or 5 mph increments (second position) (Canada: 1 km/h or 10 km/h)
- ③ Cancel cruise control
- ④ Resume to last set speed

Setting current speed

- ▶ Accelerate or decelerate to the desired speed.
- ▶ Briefly lift ① or depress ② the cruise control lever.

The current speed is set.

- ▶ Remove your foot from the accelerator pedal.

The cruise control is activated.

The last set speed appears in the multi-function display for approximately five seconds.

Controls in detail

Driving systems



On uphill grades, the cruise control may not be able to maintain the set speed. Once the grade eases, the set speed will be resumed.

On downhill grades, the cruise control maintains the set speed with braking from the vehicle's braking system. In addition, on longer downhill grades the automatic transmission will automatically downshift.

Canceling cruise control

There are several ways to cancel the cruise control:

- ▶ Step on the brake pedal.

The cruise control is canceled. The last speed set is stored for later use.

or

- ▶ Briefly push the cruise control lever in direction of arrow ③ (▷ page 239).

The cruise control is canceled. The last speed set is stored for later use.



The last stored speed is canceled when you turn off the engine.



The cruise control switches off automatically when

- you step on the brake pedal
- you depress the parking brake pedal

The cruise control also switches off automatically when

- the vehicle speed is below 20 mph (30 km/h)
- the ESP[®] is in operation or switched off with the ESP[®] switch (▷ page 97)
- you set the automatic transmission to **N** while driving

An acoustic warning sounds and the message *Cruise control OFF* appears in the multifunction display.

Controls in detail

Driving systems



Setting the automatic transmission to **N** while driving cancels the cruise control. However, the automatic transmission should not be set to **N** while driving except to coast when the vehicle is in danger of skidding (e.g. on icy roads).



Depressing the accelerator pedal does not deactivate the cruise control. After brief acceleration (e.g. for passing), the cruise control will resume the last speed set.

Setting a higher speed

You can increase the speed in two stages.

Adjustment in 1 mph (Canada: 1 km/h) increments



The set value is increased in 1 mph (Canada: 1 km/h) increments each time you lift the cruise control lever to the resistance point.

- ▶ Lift the cruise control lever to the resistance point in direction of arrow ① (▷ page 239) and hold it up until the desired speed is reached.
- ▶ Release the cruise control lever.
The new speed is set.

Adjustment in 5 mph

(Canada: 10 km/h) increments

Warning!



You can increase the vehicle speed in 5 mph (Canada 10 km/h) increments. When using this feature, keep in mind that it may take a brief moment until the vehicle has reached the set speed.

Increase the vehicle speed to a value that the prevailing road conditions permit. Otherwise, sudden and unexpected acceleration of the vehicle could cause an accident and/or serious injury to you and others.



The set value is increased in 5 mph (Canada: 10 km/h) increments each time you lift the cruise control lever past the resistance point.

Controls in detail

Driving systems

- ▶ Briefly lift the cruise control lever past the resistance point in direction of arrow ① (▷ page 239).

The vehicle speed increases in increments of 5 mph (Canada: 10 km/h).



The new speed is set and the vehicle will accelerate. Keep in mind that it may take a brief moment until the vehicle has reached the set speed.

Setting a lower speed

You can reduce the speed in two stages.



When you use the cruise control lever to decelerate, the brake system will automatically brake the vehicle if the engine's braking power does not brake the vehicle sufficiently.

Adjustment in 1 mph (Canada: 1 km/h) increments



The set value is decreased in 1 mph (Canada: 1 km/h) increments each time you depress the cruise control lever to the resistance point.

- ▶ Press the cruise control lever down to the resistance point in direction of arrow ② (▷ page 239) and hold it down until the desired speed is reached.
- ▶ Release the cruise control lever.

The new speed is set.

Adjustment in 5 mph (Canada: 10 km/h) increments

Warning!



You can decrease the vehicle speed in 5 mph (Canada 10 km/h) increments. When using this feature, keep in mind that it may take a brief moment until the vehicle has reached the set speed.

Decelerate the vehicle speed to a value that the prevailing road conditions permit. Otherwise, sudden and unexpected deceleration of the vehicle could cause an accident and/or serious injury to you and others.



The set value is decreased in 5 mph (Canada: 10 km/h) increments each time you press the cruise control lever down past the resistance point.

- ▶ Briefly press the cruise control lever down past the resistance point in direction of arrow ② (▷ page 239).

The vehicle speed decreases in increments of 5 mph (Canada: 10 km/h).



The new speed is set and the vehicle will decelerate. Keep in mind that it may take a brief moment until the vehicle has reached the set speed.

Setting to last stored speed (“Resume” function)

Warning!



The speed stored in memory should only be set again if prevailing road conditions permit. Possible acceleration or deceleration differences arising from returning to the pre-set speed could cause an accident and/or serious injury to you and others.

- ▶ Briefly pull the cruise control lever in direction of arrow ④ (▷ page 239).
The cruise control resumes the last set speed.
- ▶ Remove your foot from the accelerator pedal.

The last set speed appears in the multi-function display for approximately five seconds.

Controls in detail

Driving systems

Downhill Speed Regulation (DSR)

Warning!



Downhill Speed Regulation is a convenience system designed to assist the driver during vehicle operation. The system must be set to be appropriate for the topographical and weather conditions encountered which can change quickly. The driver is and must remain at all times responsible for the vehicle speed and for safe brake operation.

Depending on the programmed speed (▷ page 176), actual vehicle speed and gradient, switching on the DSR while driving can cause the vehicle to slow down rapidly and you may hear a sound which is caused by the activation of the vehicle’s brake system through the DSR. Sudden and unexpected deceleration can result in loss of vehicle control, causing an accident and/or serious personal injury to you and others. Do not switch on the DSR in a circumstance where rapid deceleration could result in a loss of vehicle control.

Controls in detail

Driving systems

For more information, see “Off-road driving” (▷ page 306).

The DSR is an aid for driving downhill. DSR regulates your vehicle’s speed when driving downhill to the value set in the control system (▷ page 176). The steeper the downhill gradient is, the greater the brake application. On flat road surfaces, DSR brakes only slightly or not at all.

DSR regulates the vehicle’s speed in automatic transmission positions **D**, or **R**.

You can drive slower or faster than the set speed at any time by braking the vehicle or depressing the accelerator pedal.



Whenever DSR is switched on, DSR will use the programmed default speed to regulate the vehicle’s speed. The default speed programmed at the factory is 4 mph (Canada: 6 km/h). The default speed can be reprogrammed using the control system (▷ page 176). The next time DSR is switched on, DSR will use the newly programmed default speed to regulate the vehicle’s speed.

Once DSR is switched on, you can adjust the set speed using the cruise control lever (▷ page 238). Keep in mind that adjusting the set speed using the cruise control lever with DSR switched on will not change the programmed default speed. If DSR is switched off and then switched on again, DSR will use the programmed default speed.

Whenever the DSR is switched on, the programmed default speed will be used. That value can be changed through the multifunction display. The next time the DSR is switched on, it will use that newly programmed default speed.

Depending on the road surface and level of downhill grade, the DSR may not be able to maintain the set speed. To maintain the set speed, apply the brakes if necessary.

Controls in detail

Driving systems

Switching the Downhill Speed Regulation on/off

The switch is located in the lower part of the center console.



Switch for DSR

- ① DSR on/off
- ② Indicator lamp

Warning!



If the accelerator pedal is depressed while the Downhill Speed Regulation is activated, the vehicle can drive faster than the programmed set speed. You should therefore drive downhill with particular caution as it could otherwise lead to an accident and/or serious injury to you or others. Keep in mind that as soon as you remove the foot from the accelerator pedal with the DSR switched on, the DSR will start regulating the vehicle's speed including use of brakes where required. Depending on the programmed set speed, actual vehicle speed and gradient, the DSR can cause the vehicle to slow down rapidly. Sudden and unexpected deceleration can result in loss of vehicle control, causing an accident and/or serious personal injury to you and others.

Switching Downhill Speed Regulation on



The DSR can only be switched on if the vehicle speed is below 18 mph (Canada: 30 km/h).

- ▶ Press DSR switch ① (▷ page 245).

The indicator lamp ② comes on.

The message DSR and the set speed appear in the multifunction display.



Controls in detail

Driving systems



If the DSR is switched on at a speed above 18 mph (Canada: 30 km/h), the message *DSR Cannot be activated, Speed too high* appears in the multifunction display.

For information on how to program the set speed while driving, see “Adjusting Downhill Speed Regulation speed with DSR switched on” (▷ page 246).

Switching Downhill Speed Regulation off

- ▶ Press DSR switch ① (▷ page 245).
The indicator lamp ② goes out.
The message *DSR off* appears in the multifunction display.



At a speed above approximately 21 mph (Canada approx.: 35 km/h), the DSR is automatically switched off. The message *DSR off* appears in the multifunction display and an acoustic signal sounds.

Adjusting Downhill Speed Regulation speed with DSR switched on

With the DSR switched on (▷ page 245), the speed setting can be changed using the cruise control lever.

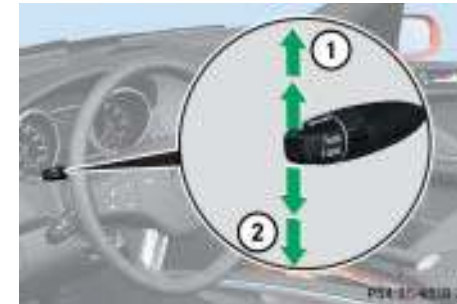

Cruise control lever

- ① Increase set speed
- ② Reduce set speed

You can change the set speed between 3- 10 mph (Canada: 4- 18 km/h).

The cruise control lever is the uppermost lever on the left-hand side of the steering column (▷ page 23).

You can increase or reduce the set speed in two stages.

Adjustment in 1 mph (Canada: 1 km/h) increments



The set value is increased in 1 mph (Canada: 1 km/h) increments each time you lift or depress the cruise control lever to the resistance point.

Increase set speed:

- ▶ Lift the cruise control lever to the resistance point in direction of arrow ① (▷ page 246) and hold it up until the desired speed is reached.
- ▶ Release the cruise control lever.

Reduce set speed:

- ▶ Press the cruise control lever to the resistance point in direction of arrow ② (▷ page 246) and hold it down until the desired speed is reached.

- ▶ Release the cruise control lever.

The new speed is set.

Each time the set speed is changed, DSR will appear in the multifunction display and the changed set speed is shown.



The set speed is canceled when DSR is switched off. If DSR is switched on again, DSR will use the programmed default speed (▷ page 176).

Adjustment in 5 mph (Canada: 10 km/h) increments



The set speed is increased in 5 mph (Canada: 10 km/h) increments each time you lift or depress the cruise control lever past the resistance point.

Increase set speed:

- ▶ Briefly lift the cruise control lever up past the resistance point in direction of arrow ① (▷ page 246).
- ▶ Release the cruise control lever.

Reduce set speed:

- ▶ Briefly press the cruise control lever down past the resistance point in direction of arrow ② (▷ page 246). ▷▷

Controls in detail

Driving systems

- ▷▷ Release the cruise control lever.

The new speed is set.

Each time the set speed is changed, DSR will appear in the multifunction display and the newly set speed is shown.



The new speed is set and the vehicle will accelerate or decelerate. Keep in mind that it may take a brief moment until the vehicle has reached the new set speed.



The set speed is canceled when DSR is switched off. If DSR is switched on again, DSR will use the programmed default speed (▷ page 176).

Off-road driving program

The off-road driving program is designed to assist the driver when driving off-road in terrain and crossing water. The off-road driving program adjusts the engine power and shifting of the automatic transmission to be more suitable for the off-road use of the vehicle. In addition, the ABS, ESP[®], and 4-ETS designed for off-road use are automatically activated.

In the following situations you should switch to the Off-road driving program:

- during off-road driving
- when crossing water
- when towing up or down on steep gradients

The switch is located on the lower part of the center console.



- ① Switch for Off-road driving program
② Indicator lamp

Switching Off-road driving program on

- ▶ Press switch ① (▷ page 248).
Indicator lamp ② comes on. The symbol  appears in the lower multifunction display.



Switching Off-road driving program off

- ▶ Press switch ① again.
Indicator lamp ② goes out. The symbol  disappears.

Air suspension package*

Air suspension automatically optimizes your vehicle's suspension tuning and regulates the vehicle level. The system consists of two components:

- Suspension tuning: Adaptive Damping System (ADS) (▷ page 249)
- Vehicle level control (▷ page 250)

Adaptive Damping System (ADS)*

The fine tuning of the damping and suspension is dependent on:

- your driving style
- road surface conditions
- your personal ADS settings
- your personal vehicle level settings

Controls in detail

Driving systems

The switch is located on the lower part of the center console.



- ① ADS switch
- ② Indicator lamp for SPORT setting
- ③ Indicator lamp for COMF setting

The following settings are available:

- **AUTO** (for normal driving situations)
Indicator lamps ② and ③ are out.
- **SPORT** (for sporty driving)
Indicator lamp ② comes on.
- **COMF** (for comfort driving)
Indicator lamp ③ comes on.

Controls in detail

Driving systems

- ▶ Start the engine (▷ page 34).
- ▶ Press ADS switch ① repeatedly until the desired suspension tuning is reached.



The setting is stored when you turn off the engine.

Vehicle level control*

The vehicle level control automatically regulates the ride height to

- reduce fuel consumption
- improve driving stability by lowering the center of gravity

The vehicle automatically regulates its ride height based on the set vehicle height and the current speed:

- The ride height of the vehicle is reduced with increasing vehicle speed.

- The ride height of the vehicle changes from the high-speed level back to the normal highway level as the vehicle speed is decreased.

The parked vehicle begins adjusting to the set vehicle level as soon the doors and tailgate are

- unlocked

or

- opened.

In order to operate the vehicle level control switch (▷ page 252), however, the engine must be running.

For safety reasons, the vehicle lowers only when all doors are closed. The lowering procedure is interrupted as soon as a door is opened. The lowering will resume as soon as all doors are closed.

Warning!



Please be aware that by raising the vehicle level, the center of gravity also rises. Therefore, always ensure that the vehicle level is as low as possible. With higher ride height the ESP[®] may activate earlier in certain situations.

Warning!



Make sure that no one is near the wheel housing or under the vehicle when you lower the vehicle while it is standing still. Limbs could become wedged into or under the vehicle.

For safety reasons, the vehicle can only be lowered with the doors closed. Lowering is interrupted if a door is opened and will continue after the door is closed again.

Controls in detail

Driving systems



Keep in mind that in rough or uneven terrain, adjusting the vehicle to a lower level may cause the vehicle underbody to come in contact with the ground and result in damage to the vehicle underbody. Always make sure the vehicle has sufficient ground clearance before adjusting it to a lower level.



Before jacking up the vehicle with equipment that lifts one or more of the wheels completely off of the ground, remove the SmartKey from the starter switch.



Please also note the information in the section on towing (> page 472).



The activation thresholds are defined by the set suspension tuning (> page 249).



The high-speed level is not available if towing a trailer. For more information on towing a trailer, see “Trailer towing” (> page 314).



For off-road driving, please observe the corresponding section in this manual (> page 306).

Controls in detail

Driving systems



The vehicle is automatically lowered to the high-speed level when the vehicle exceeds a certain speed threshold and is automatically raised to the highway level when vehicle speed drops below a certain speed threshold. Note the exception in the ADS SPORT mode, where the system disregards the highway level and automatically lowers the vehicle to the high-speed level.

In comparison to vehicle behavior when in the ADS AUTO mode,

- the vehicle is lowered to the high-speed level when set to the SPORT mode,
- and remains at the highway level over a greater speed range when set to the COMFORT mode.

Setting the vehicle level*

The switch is located on the lower part of the center console.



- ① Vehicle level switch
- ② Indicator lamp

The following vehicle chassis ride heights can be selected using the vehicle level switch in the center console:

Level	Driving situation
Raised	For off-road driving or driving in rough terrain. The indicator lamp is on.
Highway/High-speed	For driving on paved roads in fair or better condition. The indicator lamp is off.

The following is the approximate change in ride height as compared to the highway level for each of the level settings:

Level	Ride height
Raised	+ 3.1 in (80 mm)
Highway	+/- 0 in (0 mm)
High-speed	- 0.6 in (-15 mm)

Controls in detail

Driving systems

Setting the raised level

Only select the raised level if appropriate for the driving situation encountered. Otherwise:

- fuel consumption may increase
 - handling characteristics of the vehicle may be unfavorable
- ▶ Start the engine (▷ page 34).





If the indicator lamp ② is off:

- ▶ Press switch ①.

Indicator lamp ② flashes. The vehicle adjusts to the raised level.

The following message appears in the multifunction display while the level is being set:



The message can be cleared by pressing the    or button  on the multifunction steering wheel.

When the raised level is reached, the following message appears in the multifunction display for five seconds:



Indicator lamp ② (▷ page 252) comes on continuously.

You can select the raised level at speeds up to 40 mph (64 km/h). At higher speeds, the message Level selection not permitted appears in the multifunction display.

Setting the highway/high-speed level

- ▶ Start the engine (▷ page 34).





If the indicator lamp ② (▷ page 252) is on:

- ▶ Press switch ① (▷ page 252).

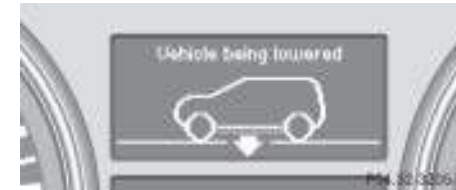
Indicator lamp ② flashes. The vehicle adjusts to the highway/high-speed level.

The following message appears in the multifunction display while the level is being set:



The message can be cleared by pressing the    or button  on the multifunction steering wheel.



Controls in detail

Driving systems

▷▷When the highway/high-speed level is reached, the following message appears in the multifunction display for five seconds:



Indicator lamp ② (▷ page 252) goes out.



The vehicle is lowered to the highway level if:

- the vehicle speed is above 55 mph (88 km/h)
- the speed stays between 40 mph (64 km/h) and 55 mph (88 km/h) for approximately 20 seconds



Depending on the ADS setting (▷ page 249), the vehicle will be lowered to the high-speed level when traveling at higher speeds. At speeds below 40 mph (64 km/h) at the latest, it will be returned to the highway level.

The following applies additionally when towing a trailer:

- The vehicle is lowered to the highway level when it reaches a speed of 5 mph (8 km/h).
- The high-speed level is not available.
- The restrictions that apply to towing also apply when using accessories that are connected to the trailer power socket, such as an accessory bicycle rack.

Parktronic* system (Parking assist)

Warning!



Parktronic is a supplemental system. It is not intended to, nor does it replace, the need for extreme care. The responsibility during parking and other critical maneuvers always rests with the driver.

Special attention must be paid to objects with smooth surfaces or low silhouettes (e.g. trailer couplings, painted posts, or road curbs). Such objects may not be detected by the system and can damage the vehicle.

The operational function of the Parktronic system can be affected by dirty sensors, especially at times of snow and ice. See “Cleaning the Parktronic system sensors” (▷ page 377).

Interference caused by other ultrasonic signals (e.g. working jackhammers, car wash, or the air brakes of trucks) can cause the system to send erratic indications, and should be taken into consideration.

Warning!



Make sure no persons or animals are in the area in which you are maneuvering. You could otherwise injure them.

The Parktronic system is an electronic parking aid and designed to assist the driver during parking maneuvers. It visually and audibly indicates the relative distance between the vehicle and an obstacle.

The Parktronic system is automatically activated when you switch on the ignition, release the parking brake, and set the automatic transmission to **D**, **R**, or **N**. The Parktronic system deactivates at speeds over approximately 11 mph (18 km/h). At lower speeds the Parktronic system turns on again.

The Parktronic system also deactivates when you set the automatic transmission to **P** or depress the parking brake pedal.

The Parktronic system monitors the surroundings of your vehicle with six sensors in the front bumper and four sensors in the rear bumper.

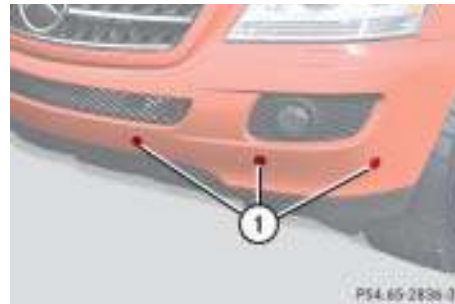

① Sensors in the front bumper

Range of the sensors

To function properly, the sensors must be free of dirt, ice, snow and slush. Clean the sensors regularly, being careful not to scratch or damaging the sensors, see “Cleaning the Parktronic* system sensors” (> page 377).

Controls in detail

Driving systems

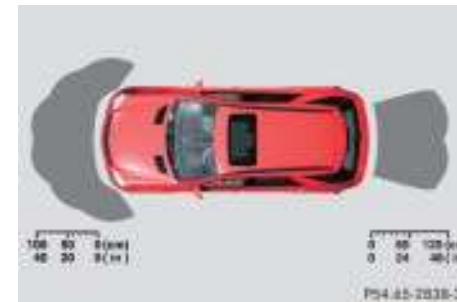
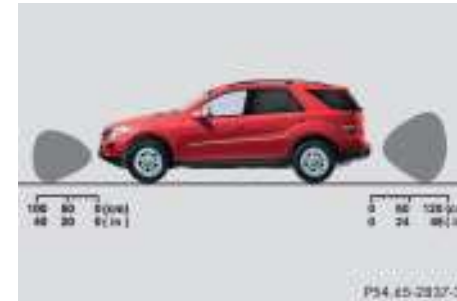

Controls in detail

Driving systems

Front sensors

Center	approx. 40 in (100 cm)
Corners	approx. 24 in (60 cm)

Rear sensors

Center	approx. 48 in (120 cm)
Corners	approx. 32 in (80 cm)



During parking maneuvers, pay special attention to objects located above or below the height of the sensors (e.g. planters or trailer hitches). The Parktronic system will not detect such objects at close range and damage to your vehicle or the object may result.

Ultrasonic signals from outside sources (e.g. working jackhammers, car wash or the air brakes of trucks) may impair the operation of the Parktronic system.

Minimum distance

Center	approx. 8 in (20 cm)
Corners	approx. 6 in (15 cm)

If the system detects an obstacle in this range, all the distance warning segments illuminate and you hear a warning signal. If the obstacle is closer than the minimum distance, the actual distance may no longer be indicated by the system.

Warning indicators

Visual signals indicate to the driver the relative distance between the sensors and an obstacle. The warning indicator for the front area is located above the center air vents in the dashboard. The warning indicator for the rear area is located in the rear passenger compartment in the roof dome.



Front area warning indicator

- ① Left side of the vehicle
- ② Right side of the vehicle
- ③ Readiness indicators

Each warning indicator is divided into five yellow and two red segments for either side of the vehicle. The Parktronic system is operational when the readiness indicators ③ are illuminated.

The position of the automatic transmission determines which warning indicator will be activated.

Automatic transmission position	Warning indicator
D	Front area activated
R or N	Front and rear area activated
P	Neither activated

As your vehicle approaches an object, one or more distance segments will come on, depending on the distance. When the second red distance segment illuminates, you have reached the minimum distance.

- Front area: An intermittent acoustic warning will sound as the first red distance segment illuminates and a constant acoustic warning lasting a maximum of two seconds will sound for the second red segment. The signal is canceled when the automatic transmission is set to **P**, or the parking brake is activated.

- Rear area: An intermittent acoustic warning will sound as the first red distance segment illuminates and a constant acoustic warning lasting a maximum of two seconds will sound for the second red segment. The signal is canceled when the automatic transmission is set to **D**, **P**, or the parking brake is activated.

Switching Parktronic* system on/off

The Parktronic system can be switched off manually using the control system (▷ page 175).

As your vehicle approaches an object, and three or more distance segments will come on, the following message appears in the multifunction display.



Controls in detail

Driving systems

- ▶ Press **+** or **-** to switch function off.

i The display disappears automatically within ten seconds if you continue to approach an object.

If the vehicle comes closer to the object and the first red distance segment comes on, the display appears continuously. It disappears if:

- you clear the message by pressing the **[left arrow]** **[right arrow]** **[down arrow]** or button **[up arrow]** on the multifunction steering wheel
- or
- the distance is increased and the third yellow distance segment goes out. ▷▷

Controls in detail

Driving systems



The message **Parktronic on** reappears as soon as the system senses that you get closer to the object again, even if you cleared the message before by pressing or button on the multifunction steering wheel.



The Parktronic system is automatically switched on when the ignition is switched on.

Vehicles with original equipment Mercedes-Benz Trailer Hitch Kit:
The rear Parktronic sensor will automatically disengage when towing a trailer as soon as the electrical connection between the vehicle and the trailer has been established.

Parktronic* system malfunction

If only the red distance segments illuminate and an acoustic warning sounds, there is a malfunction in the Parktronic system. The Parktronic system will automatically switch off after 20 seconds.

- ▶ Have the Parktronic system checked by an authorized Mercedes-Benz Light Truck Center as soon as possible.

If only the red distance segments illuminate and no acoustic warning sounds, the Parktronic system sensors are dirty or there is an interference from other radio or ultrasonic signals. The Parktronic system will automatically switch off after 20 seconds.

- ▶ Switch off the ignition (▷ page 34).
- ▶ Clean the Parktronic system sensors (▷ page 377).
- ▶ Switch on the ignition.

or

- ▶ Check the Parktronic system operation at another location to rule out interference from outside radio or ultrasonic signals.

▼ Loading

Loading instructions

Warning!



Always fasten items being carried as securely as possible using cargo tie-down rings and fastening materials appropriate for the weight and size of the load.

In an accident, during hard braking or sudden maneuvers, loose items will be thrown around inside the vehicle, and can cause injury to vehicle occupants unless the items are securely fastened in the vehicle.

To help avoid personal injury during a collision or sudden maneuver, always use partition net when transporting cargo.

Never drive vehicle with the tailgate open. Deadly carbon monoxide (CO) gases may enter vehicle interior resulting in unconsciousness and death.



Load distribution

The gross vehicle weight which is the weight of the vehicle including fuel, tools, spare wheel, installed accessories, passengers and luggage/cargo must never exceed the load limit and Gross Vehicle Weight Rating (GVWR) for your vehicle as specified on the placard(s) located on the driver's door B-pillar. In addition, the load must be distributed in such a way so that the weight on each axle never exceeds the Gross Axle Weight Rating (GAWR) for the front and rear axle. The GVWR and GAWR for your vehicle are indicated on the certification label which can be found on the driver's door B-pillar.

The handling characteristics of a fully loaded vehicle depend greatly on the load distribution. It is therefore recommended to load the vehicle according to the illustrations shown, with the heaviest items being placed towards the front of the vehicle.

Please pay attention to and comply with the following instructions when loading the vehicle and transporting cargo:

- Always place items being carried against front or rear seat backrests, and fasten them as securely as possible.
- The heaviest portion of the cargo should always be kept as low as possible against front or rear seat backrests.

Controls in detail

Loading



For additional safety when transporting cargo while the rear seats are unoccupied, fasten the outer seat belts crosswise into the opposite side buckles.



The cargo compartment is the preferred place to carry objects. The enlarged cargo compartment should only be used for items which do not fit in the cargo compartment alone.

Cargo tie-down rings

The vehicle is equipped with six tie-down rings.

Four tie-down rings are located in the cargo compartment.



① Cargo tie-down ring

Two additional tie-down rings are located on the floor in front of the rear bench seat.



① Cargo tie-down ring

- ▶ Carefully secure cargo by applying even load on all rings with rope of sufficient strength to hold down the cargo.



While the partition net* will help protect you from smaller objects, it cannot prevent the movement of large, heavier objects into the passenger compartment in an accident, during hard braking or sudden maneuvers. Such items must be properly secured using the cargo tie-down rings.

Hooks

Four hooks located on the rear compartment trim panels, two on each side.



① Hook

Use the hooks to secure light weight items. The maximum permissible weight per hook is 9 lbs (4 kg).

Split rear bench seat

To expand the cargo compartment, you can fold down the left and right rear seat backrests.

The two sections can be folded down separately to enlarge the cargo compartment.

Warning!



When expanding the cargo compartment, always fold the seat cushions fully forward and always use the partition net when transporting cargo.

Unless you are transporting cargo, the backrests must remain properly locked in the upright position.

In an accident, during hard braking or sudden maneuvers, loose items will be thrown around inside the vehicle, and can cause injury to vehicle occupants unless the items are securely fastened in the vehicle.

Always use the cargo tie down rings (> page 260).

Folding the backrest forward



Always release the seat cushion and fold it up before folding the seat backrests forward. The covering on the seat backrest may otherwise be damaged.

When the rear bench seat is folded forward, the front seats cannot be moved to the rearmost position. Otherwise you could damage the front seats and the rear bench seat.

Controls in detail

Loading



- ① Release handle
- ② Seat cushion

- ▶ Pull release handle ①.
- ▶ Fold the seat cushion ② forward.



- ③ Release handle
- ④ Seat backrest

- ▶ Make sure the rear seat head restraints are in the lowermost position (▷ page 130).
- ▶ Pull release handle ③.
- ▶ A red indicator will be visible and the seat backrest is released.
- ▶ Fold the seat backrest ④ forward.

Returning seat backrest to original position



- ① Seat backrest
- ② Seat cushion

- ▶ Fold seat backrest ① rearward until it engages.
- ▶ The red indicator no longer should be visible.
- ▶ Fold seat cushion ② rearward until it locks into position.
- ▶ Check for secure locking by pushing and pulling on the seat backrest.

Warning!



If a red indicator is visible with the backrest up, then the backrest is not properly locked into position.

Always lock backrest in its upright position when the rear seats are occupied, or the extended cargo compartment is not in use. Check for secure locking by pushing and pulling on the backrest.

Partition net*

Warning!



Always lock backrest in its upright position when rear seat bench is occupied by passengers, or cargo is being carried behind the seat bench.

To help avoid personal injury from smaller objects being thrown around in the occupant compartment during a collision or sudden maneuver, always use partition net when transporting cargo.

The partition net cannot prevent the movement of large, heavier objects into the passenger compartment in an accident. Such items must be properly secured using the cargo tie-down rings (▷ page 260) in the cargo compartment floor.

Passenger use of seats behind installed partition net is restricted because of the footwell being taken up by the net.

Controls in detail

Loading

Use of the partition net is a particularly important safety factor when the vehicle is loaded higher than the top of the seat backrests with smaller objects.

The partition net can be installed behind the backrests of the front or rear seats.

- ▶ Open the partition net zipper.
- ▶ Roll out the partition net.
- ▶ Unfold the partition net until it audibly engages.

Engaging partition net

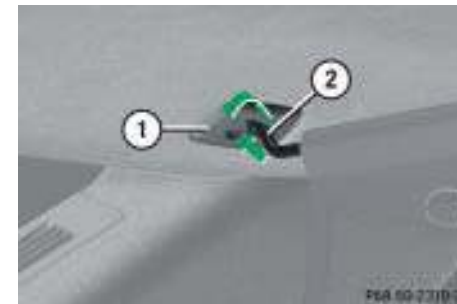

- ① Holder
- ② Mounting hook

Controls in detail

Loading

- ▶ One after the other, engage the two mounting hooks ② in the holder ①.
- ▶ Push both mounting hooks ② forward into holder ①.

Tightening partition net

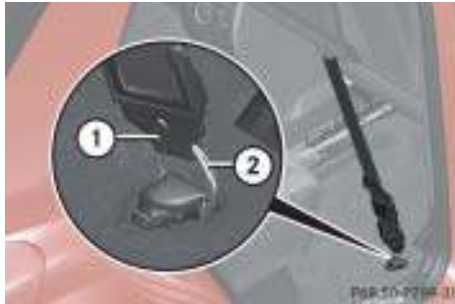

Installation behind the front seats

- ① Tie-down hook
- ② Ring

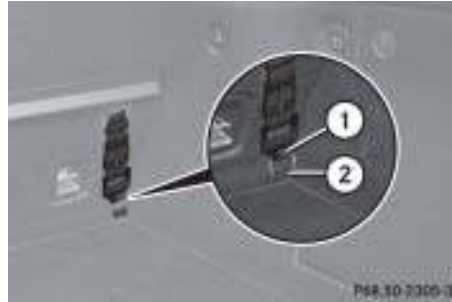

Installation behind the rear seats

- ① Tie-down hook
- ② Ring

- ▶ Insert tie-down hook ① in rings ②.

Removing partition net

- ▶ Disengage tie-down hooks ① from rings ②.
- ▶ Remove mounting hooks ② (▷ page 263) from holder ① (▷ page 263).
- ▶ Roll up and close the partition net.



When storing the partition net after use, press the red button on the partition net bar to fold in.

- ▶ Store partition net behind rear seat bench.

Cargo compartment cover*

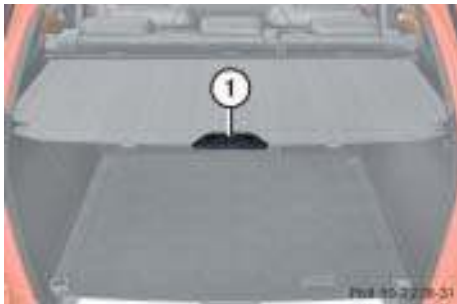

① Handle

Closing cover

- ▶ Pull cargo compartment cover back by handle ① until it engages into its anchorages on the left and right side.

Opening cover

- ▶ Disengage cover and guide retraction by its handle ①.

Removing cover



② Button

③ Mounting sleeve

- ▶ Open the cover (▷ page 265).
- ▶ Press button ② and push mounting sleeve ③ inward against spring pressure until it disengages.
- ▶ Remove cover from mounts.

Installing cover

- ▶ Place left side of cover in left mount.
- ▶ Position right side of cover over right mount.
- ▶ Press button ②, releasing mounting sleeve ③ to slide into mount.
- ▶ Make sure the cargo compartment cover blind is securely fastened.

Cargo management system*

Your vehicle may be equipped with a cargo management system and accompanying accessories which enables you to utilize your cargo compartment in a variety of ways. You can store the cargo management system in the pouch that comes with the vehicle.



The pouch and the telescoping rod are located under the cargo compartment floor.

Controls in detail

Loading



① Cargo rails

Inserting the mounting elements into the cargo rails

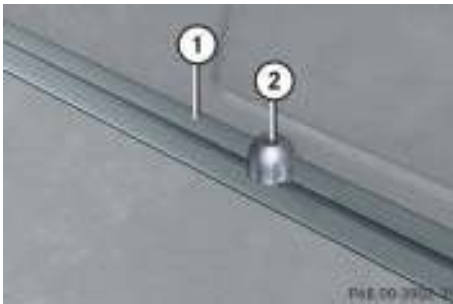

① Cargo rail
② Mounting element

You can move the mounting element ② to various engaging points on the cargo rail ① and fix it in place.

These engaging points are located 2 inches apart from one another on the cargo rail and are indicated by markings.



You can turn the mounting element in the cargo rail to four positions:



To lock the mounting element.



To insert or remove the cargo tie-down ring, the belt reel or the telescoping rod.



To insert or remove the mounting element.



To move the mounting element to the next engaging point.

- ▶ Turn mounting element ② to
- ▶ Insert mounting element ② in cargo rail ①.
- ▶ Turn mounting element ② until it engages in the

You should be able to feel the mounting element engage in the cargo rail.

Inserting the cargo tie-down ring in the mounting element



① Cargo tie-down ring
② Mounting element



Controls in detail

Loading

Warning!



The cargo tie-down rings should be subject to equal loads. Make sure to comply with the information provided in the loading instructions (▷ page 259).

- ▶ Turn mounting element ② in the cargo rail to .
- ▶ Insert cargo tie-down ring ① into mounting element ②.
- ▶ Turn mounting element ② until it engages in the  position.

You should be able to feel the mounting element engage in the cargo rail.



Belt reel



- ① Belt reel
- ② Mounting element
- ③ Locking button



The belt reel can be used to tighten light-weight loads against the side wall of the cargo compartment, thus securing them from slipping.

- ▶ Insert two mounting elements ② into a cargo rail.
- ▶ Turn mounting element ② in the cargo rail to .
- ▶ Insert belt reel ① into mounting element ②.
- ▶ Turn mounting element ② in the cargo rail until it engages in the  position.

You should be able to feel the mounting element engage in the cargo rail.

- ▶ Press locking button ③ on the belt reel ① and pull cargo net out in direction of arrow.
- ▶ Place load between the cargo net and the side wall of the cargo compartment.
- ▶ Press locking button ③ on belt reel ①. With the other hand, slowly pull net over load until it is taut.

Controls in detail

Loading

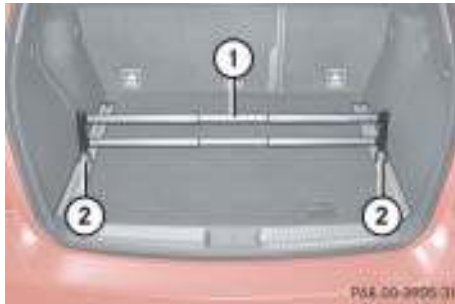

Telescoping rod



- ① Telescoping rod
- ② Mounting element



The telescoping rod can be used to tighten the load against the rear seats so as to secure it from slipping.

- ▶ Insert one mounting element ② into each cargo rail.
- ▶ Turn mounting element ② in cargo rail to .
- ▶ Insert telescoping rod ① into mounting element ②.
- ▶ Turn mounting element ② in cargo rail until it engages in the  position. You should be able to feel the mounting element engage in the cargo rail.

Removing rear seat cushions

If your vehicle is equipped with the cargo management system* you can remove the rear seat cushions.

Removing the rear seat cushions will provide you with a larger, flat cargo compartment.

- ▶ Fold the seat cushions forward ([▷ page 262](#)).

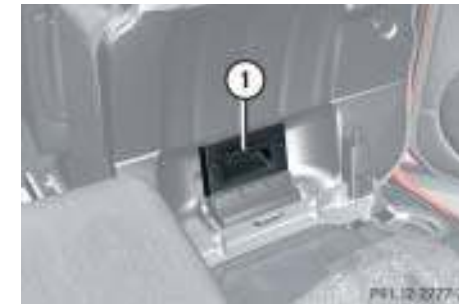

- ① Release lever

- ▶ Pull seat cushion release lever ① and remove the seat cushion by pulling it upward.

Controls in detail

Loading

- ▶ Remove the head restraints (▷ page 131).



Leave the seat cushion hinge in this position. The upholstery could be damaged if you fold the hinge back.



- ▶ Fold the seat backrest forward (▷ page 262).

Roof rack*

Warning!



Take into consideration that when the roof rack is loaded, the handling characteristics are different from those when operating the vehicles without the roof rack loaded.

The maximum roof load when using roof rack systems is 220 lb (100 kg).



Roof rails



Attach roof racks to the roof rails only.

Only use those roof racks approved by Mercedes-Benz for your vehicle model. Follow manufacturer's installation instructions.

The vehicle could otherwise be damaged.

For further information, inquire at your Mercedes-Benz Light Truck Center.

Controls in detail

Useful features

Storage compartments

Warning!



To help avoid personal injury during a collision or sudden maneuver, exercise care when storing objects in the vehicle. Put luggage or cargo in the cargo compartment if possible. Do not pile luggage or cargo higher than the seat backs.

Always use partition net when transporting cargo. Partition net cannot secure hard or heavy objects.

Parcel nets cannot secure hard or heavy objects.

Keep compartment lids closed. This will help to prevent stored objects from being thrown about and injuring vehicle occupants during an accident.

Parcel net in front passenger footwell

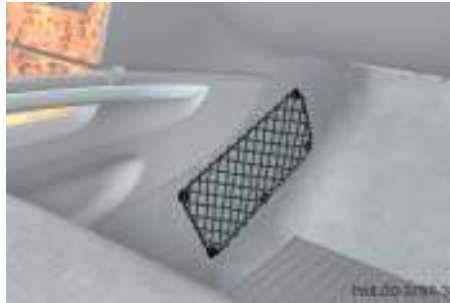

A small convenience parcel net is located in the front passenger footwell. It is for small and light items, such as road maps, mail, etc.

Warning!



The parcel net is intended for storing light-weight items only.

Heavy objects, objects with sharp edges or fragile objects may not be transported in the parcel net.

The parcel net cannot protect transported goods in the event of an accident.

Glove box



- ① Glove box lid release
- ② Glove box lid

Opening the glove box

- ▶ Grab in recess and pull lid release ①.
Glove box lid ② opens downward.

Closing the glove box

- ▶ Push glove box lid ② up to close.

Controls in detail

Useful features



- ① Unlocked
- ② Locked

Locking the glove box

- ▶ Insert mechanical key (▷ page 435) into the glove box lock and turn it to position ②.

Unlocking the glove box

- ▶ Turn mechanical key in the glove box lock to position ①.

Storage compartment in the center console

Vehicles without ashtray*



- ▶ Briefly press the front of the cover. The cover opens automatically.

Storage compartment (depending on vehicle configuration)



- ▶ Briefly press the front of the cover. The cover opens automatically.

Controls in detail

Useful features

Armrest storage compartment in the front

A flat storage tray with a deeper storage compartment underneath is located below the armrest. Both can be opened separately.



- ① Button to open storage tray
- ② Button to open storage compartment



- ③ Example storage compartment (incl. coin holder)

Opening the storage tray

- ▶ Pull button ① and lift up armrest.

Opening the storage compartment

- ▶ Pull button ② and lift up armrest.

Storage compartment in the rear center console



- ▶ Briefly press the front of the cover. It extends automatically.

Controls in detail

Useful features

Storage compartment in the rear armrest



- ▶ Fold down the rear armrest.
- ▶ Press the handle upward and fold the armrest up.

Parcel net on the front seat backrest

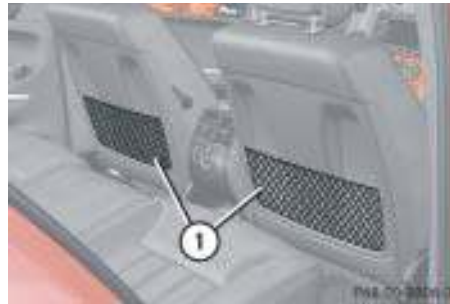

① Parcel net

A small convenience parcel net is located on each of the front seat backrests. It is for small and light items, such as road maps, mail, etc.

Warning!



The parcel net is intended for storing light-weight items only.

Do not place more than 4.4 lbs (2 kg) into the parcel net on the back of the front passenger seat. Otherwise, the OCS may not be able to properly approximate the occupant weight category.

Heavy objects, objects with sharp edges or fragile objects may not be transported in the parcel net.

The parcel net cannot protect transported goods in the event of an accident.

Controls in detail

Useful features

Cup holders

Warning!



In order to help prevent spilling liquids on vehicle occupants and/or vehicle equipment, only use containers that fit into the cup holder. Use lids on open containers and do not fill containers to a height where the contents, especially hot liquids, could spill during braking, vehicle maneuvers, or an accident. Liquids spilled on vehicle occupants may cause serious personal injury. Liquids spilled on vehicle equipment may cause damage not covered by the Mercedes-Benz Limited Warranty.

When not in use, keep rear the cup holder closed. An open cup holder may cause injury to you or others when contacted during braking, vehicle maneuvers, or in an accident.

Keep in mind that objects placed in the cup holder may come loose during braking, vehicle maneuvers, or an accident and be thrown around in the vehicle interior. Objects thrown around in the vehicle interior may cause an accident and/or serious personal injury.

Cup holder in front of armrest



① Cup holder

Cup holder in rear armrest



Opening cup holder

- ▶ Pull the armrest down by its top (▷ page 275).
- ▶ Briefly touch the cover in direction of arrow.

The cup holder opens automatically.

Closing cup holder

- ▶ Slide cup holder in until it engages.



Close the cup holder before folding the armrest upwards.

Removing and reinstalling cup holder

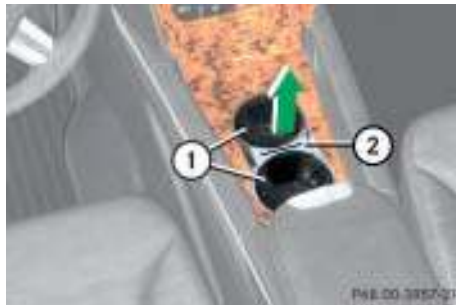

- ① Cup holder
- ② Cup holder bridge

- ▶ Hold cup holder at its bridge ② and pull out bridge in direction of arrow.
- ▶ Pull cup holder ① out in direction of arrow.
- ▶ Insert the cup holder ① and then insert bridge ②.

Armrest in rear seat bench



- ▶ Pull the armrest down by its top.

Controls in detail

Useful features

Ashtrays*

Center console ashtray



- ① Ashtray insert
- ② Cover plate

Opening the ashtray

- ▶ Briefly touch cover plate ②.
The ashtray opens automatically.

Controls in detail

Useful features

Removing ashtray insert

- ▶ Grip the ashtray insert ① on the sides and pull it out upwards.

Reinstalling ashtray insert

- ▶ Install ashtray insert ①.

Rear center console ashtray



Close the ashtray in the rear center console before folding the rear seat bench.



Cover plate for rear ashtray

Opening rear ashtray

- ▶ Briefly touch cover plate.
The ashtray opens automatically.

Removing rear ashtray insert

- ▶ Grip the insert on the sides and pull it out upwards.

Reinstalling rear ashtray insert

- ▶ Install ashtray insert.
- ▶ Close the ashtray.

Cigarette lighter

- ▶ Switch on the ignition.
- ▶ Push in cigarette lighter.

The cigarette lighter will pop out automatically when hot.

Cigarette lighter*



① Cigarette lighter

- ▶ Switch on the ignition (▷ page 34).
- ▶ Open the ashtray (▷ page 275).
- ▶ Push in cigarette lighter ①.

The cigarette lighter will pop out automatically when hot.

Warning!



Never touch the heating element or sides of the cigarette lighter; they are extremely hot. Hold the knob only.

When leaving the vehicle always remove the SmartKey or SmartKey with KEYLESS-GO* from the starter switch, take it with you, and lock the vehicle. Do not leave children unattended in the vehicle, or with access to an unlocked vehicle. Unsupervised use of vehicle equipment may cause an accident and/or serious personal injury.



The cigarette lighter socket can be used to accommodate electrical accessories up to a maximum of 180 W.

If the engine is off, and the cigarette lighter is being used extensively, the vehicle battery may become discharged.

12-V sockets



The power outlets can be used to accommodate electrical consumers (e.g. air pump, auxiliary lamps) up to a maximum of 240 W.

If the engine is off, the battery may become discharged if used for long periods of time.

Power outlets are located in the front passenger footwell, the rear passenger footwell, and the right-hand side of the cargo compartment.

- ▶ Switch on the ignition (▷ page 34).

Controls in detail

Useful features

Power outlet in front passenger footwell



- ▶ Flip up cover and insert electrical plug (cigarette lighter type).

Power outlet in rear passenger footwell



- ▶ Flip up cover and insert electrical plug (cigarette lighter type).

Power outlet in cargo compartment



- ▶ Flip up cover and insert electrical plug (cigarette lighter type).

Floormats*

Warning!



Whenever you are using floormats, make sure there is enough clearance and that the floormats are securely fastened.

Floormats should always be securely fastened using eyelets ② and retainer pins ①.

Before driving off, check that the floormats are securely in place and adjust them if necessary. A loose floormat could slip and hinder proper functioning of the pedals.

Do not place several floormats on top of each other as this may impair pedal movement.



To install or remove the floormat more easily, move the driver's seat or front passenger seat as far to the rear as possible (▷ page 39).

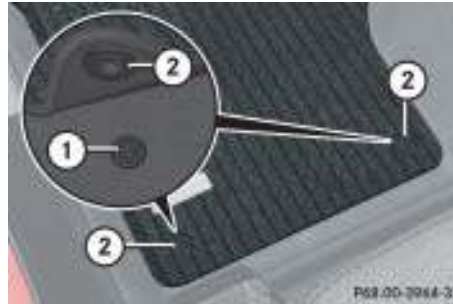

① Retainer pin

② Eyelet

Removing

- ▶ Pull floormat off of retainer pins ①.
- ▶ Remove the floormat.

Installing

- ▶ Lay down the floormat.
- ▶ Press the floormat eyelets ② onto retainer pins ①.

Telephone*

Warning!



Never operate radio transmitters equipped with a built-in or attached antenna (i.e. without being connected to an external antenna) from inside the vehicle while the engine is running. Doing so could lead to a malfunction of the vehicle's electronic system, possibly resulting in an accident and/or serious personal injury.

Radio transmitters, such as a portable telephone or a citizens band unit, should only be used inside the vehicle if they are connected to an antenna that is installed on the outside of the vehicle.

The external antenna must be approved by Mercedes-Benz. Please contact an authorized Mercedes-Benz Light Truck Center for information on the installation of an approved external antenna. Refer to the radio transmitter operation instructions regarding use of an external antenna.

Controls in detail

Useful features

Warning!





Please do not forget that your primary responsibility is to drive the vehicle. A driver's attention to the road must always be his /her primary focus when driving. For your safety and the safety of others, we recommend that you pull over to a safe location and stop before placing or taking a telephone call.

If you choose to use the telephone¹ while driving, please use the hands-free device and only use the telephone when road, weather and traffic conditions permit. Some jurisdictions prohibit the driver from using a cellular telephone while driving a vehicle.

Only operate the Modular COMAND System¹ if road, weather and traffic conditions permit.

Bear in mind that at a speed of just 30 mph (approximately 50 km/h), your vehicle is covering a distance of 44 feet (approximately 14 m) every second.

¹ Observe all legal requirements

You can take and place telephone calls using the  and  buttons on the steering wheel. To carry out other telephone functions, use the control system (▷ page 178).

See separate instruction manual for information on how to operate the telephone.

Tele Aid*



The initial activation of the Tele Aid system may only be performed by completing the subscriber agreement and placing an acquaintance call using the  button. Failure to complete either of these steps will result in a system that is not activated.

If you have any questions regarding activation, please call the Response Center at 1-800-756-9018 (in the USA) or 1-888-923-8367 (in Canada).

Shortly after the completion of your Tele Aid acquaintance call, you will receive a user ID and password. By visiting www.mbusa.com and selecting "Tele Aid" (USA only), you will have access to account information, remote door unlock and more.

The Tele Aid system

(Telematic Alarm Identification on Demand)



The Tele Aid system consists of three types of response:

- automatic and manual emergency
- roadside assistance
- information

The Tele Aid system is operational providing that the vehicle's battery is charged, properly connected, not damaged and cellular and GPS coverage is available.



The speaker volume of a Tele Aid call can be adjusted when using the volume control on the Modular COMAND System or on the multifunction steering wheel. To raise, turn the rotary volume control on Modular COMAND System clockwise or press button **+** on the multifunction steering wheel. To lower, turn the rotary volume control on Modular COMAND System con-

trol counterclockwise or press button **-** on the multifunction steering wheel.

- ▶ To activate, press the SOS button  or the Roadside Assistance button  or the Information button , depending on the type of response required.



The SOS button is located in the overhead control panel.

The Roadside Assistance button  and the Information button  are located below the center armrest cover.



The Tele Aid system utilizes the cellular network for communication and the GPS (Global Positioning System) satellites for vehicle location. If either of these signals are unavailable, the Tele Aid system may not function and if this occurs, assistance must be summoned by other means.

Controls in detail

Useful features





When a Tele Aid call has been initiated, the Modular COMAND System audio is muted and the selected mode (radio, CD etc.) pauses. The optional cellular phone (if installed) inserted in cradle switches off. If you must use this phone, we recommend that you use it only with the vehicle at a standstill in a safe location. Remove the phone from the cradle and place the call. The navigation* system (if engaged) will continue to run. The display in the instrument cluster is available for use, and spoken commands are only available by pressing the RPT button on the Modular COMAND System. A pop-up window will appear in the Modular COMAND System display to indicate that a Tele Aid call is in progress. After the Tele Aid call has ended, the optional cellular phone inserted in the cradle switches on again. A PIN entry might be necessary.

Controls in detail

Useful features

System self-check

Initially, after switching on the ignition, malfunctions are detected and indicated (the indicator lamps in the SOS button, the Roadside Assistance button  and the Information button  stay on longer than ten seconds or do not come on). The message Malfunction. Drive to workshop appears in the multifunction display.

Warning!



If the indicator lamps on the SOS button, on the Roadside Assistance button, and/or on the Information button remain illuminated continuously in red and/or the message Malfunction. Drive to workshop is displayed in the multifunction display after the system self-check, a malfunction in the system has been detected.

If a malfunction is indicated as outlined above, the system may not operate as expected. Have the system checked at the nearest Mercedes-Benz Light Truck Center as soon as possible.

Emergency calls

An emergency call is initiated automatically following an accident in which the emergency tensioning devices (ETDs) or air bags deploy.

An emergency call can also be initiated manually by opening the cover next to the interior rear view mirror labeled SOS, then briefly pressing the button located under the cover. See (▷ page 284) for instructions on initiating an emergency call manually.

Once the emergency call is in progress, the indicator lamp on the SOS button will begin to flash. The message *Connecting Call* appears in the multifunction display. When the connection is established, the message *Call connected* appears in the multifunction display. All information relevant to the emergency, such as the location of the vehicle (determined by the GPS satellite location system), vehicle model, identification number and color are generated.

A voice connection between the Response Center and the occupants of the vehicle will be established automatically soon after the emergency call has been initiated. The Response Center will attempt to determine more precisely the nature of the accident provided they can speak to an occupant of the vehicle.

The Tele Aid system is available if

- it has been activated and is operational. Activation requires a subscription for monitoring services, connection and cellular air time
- vehicle battery power is available
- the relevant cellular phone network and GPS signals are available and pass the information on to the response center



Location of the vehicle on a map is only possible if the vehicle is able to receive signals from the GPS satellite network and pass the information on to the Response Center.

Controls in detail

Useful features

Warning!



If the indicator lamp in the SOS button is flashing continuously and there was no voice connection to the Response Center established, then the Tele Aid system could not initiate an emergency call (e.g. the relevant cellular phone network is not available). The message *Call failed* appears in the multifunction display for approximately ten seconds.

Should this occur, assistance must be summoned by other means.

Controls in detail

Useful features

Initiating an emergency call manually



- ① Cover
- ② SOS button
- ▶ Briefly press on cover ①.
The cover will open.
- ▶ Press SOS button ② briefly.
The indicator lamp in SOS button ② will flash until the emergency call is concluded.
- ▶ Wait for a voice connection to the Response Center.
- ▶ Close cover ① after the emergency call is concluded.

Warning!



If you feel at any way in jeopardy when in the vehicle (e.g. smoke or fire in the vehicle, vehicle in a dangerous road location), please do not wait for voice contact after you have pressed the emergency button. Carefully leave the vehicle and move to a safe location. The Response Center will automatically contact local emergency officials with the vehicle's approximate location if they receive an automatic SOS signal and cannot make voice contact with the vehicle occupants.

Roadside Assistance button

The Roadside Assistance button  is located below the center armrest cover.



- ① Roadside Assistance button 
- ▶ Open the storage tray (▷ page 272).
- ▶ Press and hold button ① (for longer than two seconds).
A call to a Mercedes-Benz Roadside Assistance dispatcher will be initiated. The button will flash while the call is in progress. The message *Connecting call* will appear in the multifunction display.

When the connection is established, the message **Call connected** appears in the multifunction display. The Tele Aid system will transmit data generating the vehicle identification number, model, color and location (subject to availability of cellular and GPS signals).



While the call is connected you can change to the navigation menu by pressing NAVI button on the Modular COMAND System unit.

A voice connection between the Roadside Assistance dispatcher and the occupants of the vehicle will be established.

- ▶ Describe the nature of the need for assistance.

The Mercedes-Benz Roadside Assistance dispatcher will either dispatch a qualified Mercedes-Benz technician or arrange to tow your vehicle to the nearest Mercedes-Benz Light Truck Center. For services such as labor and/or towing, charges may apply. Refer to the Roadside Assistance Manual for more information.



These programs are only available in the USA:

- Sign and Drive services: Services such as jump start, a few gallons of fuel or the replacement of a flat tire with the vehicle spare tire are obtainable.

Controls in detail

Useful features





The indicator lamp on the Roadside Assistance button  remains illuminated in red for approximately ten seconds during the system self-check after switching on the ignition (together with the SOS button and the Information button .

See system self-check (▷ page 282) if the indicator lamp does not come on in red or stays on longer than approximately ten seconds.

Controls in detail

Useful features

If the indicator lamp on the Roadside Assistance button  is flashing continuously and there was no voice connection to the Response Center established, then the Tele Aid system could not initiate a Roadside Assistance call (e.g. the relevant cellular phone network was not available). The message *Call failed* appears in the multifunction display.

Roadside Assistance calls can be terminated using the  button on the multifunction steering wheel or the END Button on the Modular COMAND System.

Information button

The Information button  is located below the center armrest cover.



① Information button

- ▶ Open the storage tray (▷ page 272).
- ▶ Press and hold button ① (for longer than two seconds).

A call to the Customer Assistance Center will be initiated. The button will flash while the call is in progress. The message *Connecting call* will appear in the multifunction display.

When the connection is established, the message *Call connected* appears in the multifunction display. The Tele Aid system will transmit data generating the vehicle identification number, model, color and location (subject to availability of cellular and GPS signals).

i

While the call is connected, you can change to the navigation menu by pressing NAVI button on the Modular COMAND System.



A voice connection between the Customer Assistance Center representative and the occupants of the vehicle will be established. Information regarding the operation of your vehicle, the nearest Mercedes-Benz Light Truck Center or Mercedes-Benz USA products and services is available to you.

For more details concerning the Tele Aid system, please visit www.mbusa.com and use your ID and password (sent to you separately) to learn more (USA only).

Controls in detail

Useful features



The indicator lamp in the Information button  remains illuminated in red for approximately ten seconds during the system self-check after switching on the ignition (together with the SOS button and the Roadside Assistance button ).

See system self-check (▷ page 282) if the indicator lamp does not come on in red or stays on longer than approximately ten seconds.

If the indicator lamp in the Information button  is flashing continuously and there was no voice connection to the Response Center established, then the Tele Aid system could not initiate an Information call (e.g. the relevant cellular phone network is not available). The message *Call failed* appears in the multifunction display.

Information calls can be terminated using the  button on the multifunction steering wheel or the END Button on the Modular COMAND System.



If the indicator lamps do not start flashing after pressing one of the buttons or remain illuminated (in red) at any time, the Tele Aid system has detected a malfunction or the service is not currently active, and may not initiate a call. Visit your authorized Mercedes-Benz Light Truck Center and have the system checked or contact the Response Center at 1-800-756-9018 (in the USA) or 1-888-923-8367 (in Canada) as soon as possible.

Call priority

If other service calls such as a Roadside Assistance call or Information call are active, an Emergency call is still possible. In this case, the Emergency call will take priority and override all other active calls.



The indicator lamp in the respective button flashes until the call is concluded. Emergency calls can only be terminated by a Response Center or Customer Assistance Center representative, whereas Roadside Assistance and Information calls can also be terminated by pressing button  on the multifunction steering wheel or using the END button on the Modular COMAND System.

Controls in detail

Useful features



If the indicator lamp continues to flash or the system does not reset, contact the Response Center at 1-800-756-9018 (in the USA) or 1-888-923-8367 (in Canada), or Mercedes-Benz Customer Assistance at 1-800-FOR-MERCEdes (1-800-367-6372) in the USA or Customer Service at 1-800-387-0100 in Canada.

Remote door unlock

In case you have locked your vehicle unintentionally (e.g. SmartKey inside vehicle), and the reserve SmartKey is not handy:

- ▶ Contact the Mercedes-Benz Response Center at 1-800-756-9018 (in the USA) or 1-888-923-8367 (in Canada).

You will be asked to provide your password which you provided when you completed the subscriber agreement.

- ▶ Then return to your vehicle and pull the tailgate recessed handle for minimum of 20 seconds until the SOS button is flashing.

The message *Connecting call* appears in the multifunction display.

As an alternative, you may unlock the vehicle via Internet using the ID and password sent to you shortly after the completion of your acquaintance call.

The Response Center will then unlock your vehicle with the remote door unlocking feature.



The remote door unlock feature is available if the relevant cellular phone network is available.

The SOS button will flash and the message *Connecting call* will appear in the multifunction display to indicate receipt of the door unlock command.

Once the vehicle is unlocked, a Response Center specialist may attempt to establish voice contact with the vehicle occupants.

If the tailgate recessed handle was pulled for more than 20 seconds before door unlock authorization was received by the Response Center, you must wait 15 minutes before pulling the tailgate recessed handle again.

Stolen Vehicle Recovery services

In the event your vehicle was stolen:

- ▶ Report the incident to the police.
The police will issue a numbered incident report.
- ▶ Pass this number on to the Mercedes-Benz Response Center along with your password issued to you when you subscribed to the service.

The Response Center will then attempt to covertly contact the vehicle's Tele Aid system. Once the vehicle is located, the Response Center will contact the local law enforcement and you. The vehicle's location will only be provided to law enforcement.



When the anti-theft alarm or the tow-away alarm stays on for more than 30 seconds, a call is initiated automatically to the Response Center. See anti-theft alarm system (▷ page 100) and tow-away alarm (▷ page 102).

Garage door opener

The built-in remote control is capable of operating up to three separately controlled devices, for example garage door openers, gate openers, or other devices compatible with HomeLink® or some other systems.

You can program the signal transmitter buttons.

Controls in detail

Useful features

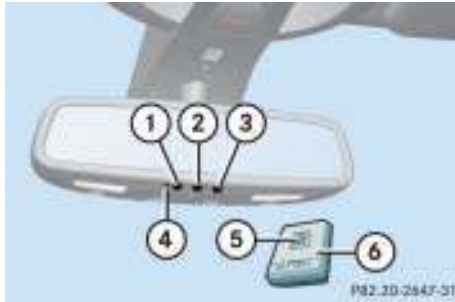

Remote control integrated into the overhead control panel

- ①,②,③ Signal transmitter button
- ④ Indicator lamp
- ⑤ Hand-held transmitter button
- ⑥ Hand-held remote control transmitter (not part of the vehicle equipment)

Warning!



Before programming the integrated remote control to a garage door opener or gate operator, make sure people and objects are out of the way of the device to prevent potential harm or damage. When programming a garage door opener, the door moves up or down. When programming a gate operator, the gate opens or closes.

Do not use the integrated remote control with any garage door opener that lacks safety stop and reverse features as required by U.S. federal safety standards (this includes any garage door opener model manufactured before April 1, 1982). A garage door that cannot detect an object - signaling the door to stop and reverse - does not meet current U.S. federal safety standards.



Certain types of garage door openers are incompatible with the integrated opener. If you should experience difficulties with programming the transmitter, contact an authorized Mercedes-Benz Light Truck Center, or call Mercedes-Benz Customer Assistance Center (in the USA only) at 1-800-FOR-MERCEdes, or Customer Service (in Canada) at 1-800-387-0100.

Controls in detail

Useful features



USA only:

This device complies with Part 15 of the FCC Rules. Operation is subject to the following two conditions:

- (1) This device may not cause harmful interference, and
- (2) this device must accept any interference received, including interference that may cause undesired operation.

Any unauthorized modification to this device could void the user's authority to operate the equipment.



Canada only:

This device complies with RSS-210 of Industry Canada. Operation is subject to the following two conditions:

- (1) This device may not cause interference, and
- (2) this device must accept any interference received, including interference that may cause undesired operation of the device.

Any unauthorized modification to this device could void the user's authority to operate the equipment.

Programming or reprogramming the integrated remote control

Step 1:

- ▶ Switch on the ignition (▷ page 34).

Step 2:

- ▶ If you have previously programmed an integrated signal transmitter button and wish to retain its programming, proceed to step 3. Otherwise, press and hold the two outer signal transmitter buttons ① and ③ and release them only when the indicator lamp ④ begins to flash after approximately 20 seconds (do not hold the button for longer than 30 seconds). This procedure erases any previous settings for all three channels and initializes the memory. If you later wish to program a second and/or third hand-held transmitter to the remaining two signal transmitter buttons, do not repeat this step and begin directly with step 3. ▷▷

Controls in detail

Useful features

▷▷Step 3:

- ▶ Hold the end of the hand-held remote control transmitter ⑥ of the device you wish to train approximately 2 to 5 in (5 to 12 cm) away from the surface of the integrated remote control located on the left side of the interior rear view mirror, keeping the indicator lamp ④ in view.

Step 4:

- ▶ Using both hands, simultaneously press the hand-held transmitter button ⑤ and the desired integrated signal transmitter button (①, ② or ③). Do not release the buttons until completing step 5.

The indicator lamp ④ on the integrated remote control will flash, first slowly and then rapidly.



The indicator lamp ④ flashes the first time the signal transmitter button is programmed. If this button has already been programmed, the indicator lamp will only start flashing after 20 seconds.

Step 5:

- ▶ When the indicator lamp ④ flashes rapidly, release both buttons.

Step 6:

- ▶ Press and hold the just-trained integrated signal transmitter button and observe the indicator lamp ④.

If the indicator lamp ④ stays on constantly, programming is complete and your device should activate when the integrated signal transmitter button is pressed and released.



If the indicator lamp ④ flashes rapidly for about two seconds and then turns to a constant light, continue with programming steps 8 through 12 as your garage door opener may be equipped with the “rolling code” feature.

Step 7:

- ▶ To program the remaining two buttons, repeat the steps above starting with step 3.

Controls in detail

Useful features

Rolling code programming

To train a garage door opener (or other rolling code devices) with the rolling code feature, follow these instructions after completing the “Programming” portion (steps 1 through 6) of this text. (A second person may make the following training procedures quicker and easier.)

Step 8:

- ▶ Locate “training” button on the garage door opener motor head unit.

Exact location and color of the button may vary by garage door opener brand. Depending on manufacturer, the “training” button may also be referred to as “learn” or “smart” button. If there is difficulty locating the transmitting button, refer to the garage door opener operator’s manual.

Step 9:

- ▶ Press “training” button on the garage door opener motor head unit.

The “training light” is activated.

You have 30 seconds to initiate the following step.

Step 10:

- ▶ Firmly press, hold for two seconds and release the programmed integrated signal transmitter button (①, ② or ③).

Step 11:

- ▶ Press, hold for two seconds and release same button a second time to complete the training process.

Some garage door openers (or other rolling code equipped devices) may require you to perform this procedure a third time to complete the training.

Step 12:

- ▶ Confirm the garage door operation by pressing the programmed integrated signal transmitter button (①, ② or ③).

Step 13:

- ▶ To program the remaining two buttons, repeat the steps above starting with step 3.

Gate operator/Canadian programming

Canadian radio-frequency laws require transmitter signals to “time-out” (or quit) after several seconds of transmission which may not be long enough for the integrated signal transmitter to pick up the signal during programming. Similar to this Canadian law, some U.S. gate operators are designed to “time-out” in the same manner.

Controls in detail

Useful features

If you live in Canada or if you are having difficulties programming a gate operator (regardless of where you live) by using the programming procedures, replace step 4 with the following:

Step 4:

- ▶ Continue to press and hold the integrated signal transmitter button (①, ② or ③) while you press and re-press (“cycle”) your hand-held remote control transmitter ⑥ every two seconds until the frequency signal has been learned. Upon successful training, the indicator lamp ④ will flash slowly and then rapidly after several seconds.
- ▶ Proceed with programming step 5 and step 6 to complete.

Operation of remote control

- ▶ Switch on the ignition (▷ page 34).
- ▶ Select and press the appropriate integrated signal transmitter button (①, ② or ③) to activate the remote controlled device.

The integrated remote control transmitter continues to send the signal as long as the button is pressed – up to 20 seconds.

Erasing the integrated remote control memory

- ▶ Switch on the ignition (▷ page 34).
- ▶ Simultaneously hold down the signal transmitter buttons ① and ③, for approximately 20 seconds, until the indicator lamp ④ flashes rapidly. Do not hold for longer than 30 seconds.

The codes of all three channels are erased.



If you sell your vehicle, erase the codes of all three channels.

Reprogramming a single integrated signal transmitter button

To program a device using a signal transmitter button previously trained, follow these steps:

- ▶ Press and hold the desired signal transmitter button (①, ② or ③). Do not release the button.
- ▶ The indicator lamp will begin to flash after 20 seconds. Without releasing the integrated signal transmitter button, proceed with programming starting with step 3.

Compass

The compass displays the direction the vehicle is traveling. The multifunction display will show you N, NE, E, SE, S, SW, W or NW (▷ page 159).



The presence of buildings, bridges, power lines and large antenna masts can influence the displayed values. Metallic or magnetic objects in or on the vehicle can influence the accuracy of the compass.

To make sure the display is correct, the compass must be set to the proper geographic zone (▷ page 171). It may also be necessary to calibrate the compass (▷ page 171).

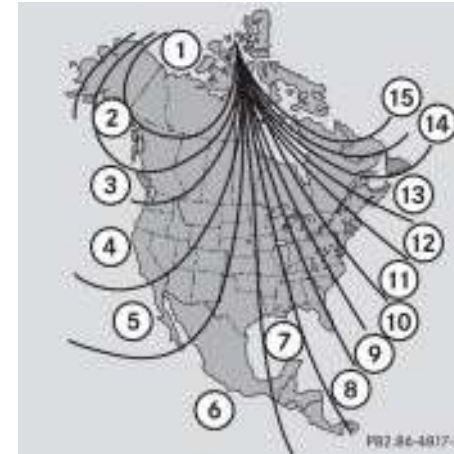

Zone map North America

Controls in detail

Useful features

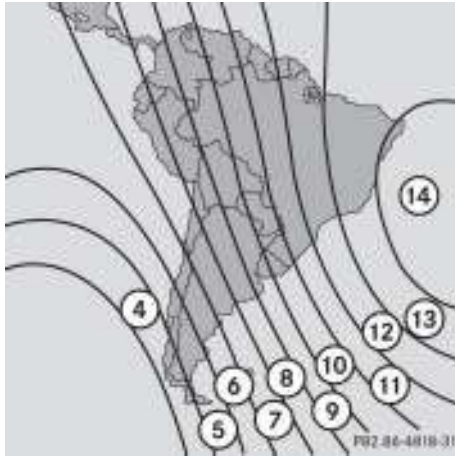

Zone map South America

Infrared reflecting windshield*



① Mounting location for electronic toll collection devices (infrared transparent)

Your vehicle is equipped with infrared reflecting glass which reduces the amount of radiated heat entering the interior through the windows.

The infrared reflecting glass also prevents the transmission of signals through the glass by in-vehicle electronic devices (e.g. electronic toll collection devices).

To allow the use of these devices in the vehicle, two infrared transparent areas (① and ②) are placed in the windshield.

Operation

The first 1000 miles (1500 km)

Driving instructions

At the gas station

Engine compartment

Tires and wheels

Winter driving

Maintenance

Vehicle care



Operation

The first 1000 miles (1500 km)

In the “Operation” section you will find detailed information on operating, maintaining and caring for your vehicle.

The more cautiously you treat your vehicle during the break-in period, the more satisfied you will be with its performance later on.

- Drive your vehicle during the first 1000 miles (1500 km) at varying but moderate vehicle and engine speeds.
- During this period, avoid heavy loads (full throttle driving) and excessive engine speeds (no more than $\frac{2}{3}$ of maximum rpm in each gear).
- Shift gears in a timely manner.
- Avoid accelerating by kick-down.
- Do not attempt to slow the vehicle down by shifting to a lower gear using the gear selector lever.
- Select positions **3**, **2** or **1** only when driving at moderate speeds (for hill driving).

After 1000 miles (1500 km) you may gradually increase vehicle and engine speeds to the permissible maximum.

All of the above instructions, as may apply to your vehicle type, also apply when driving the first 1000 miles (1500 km) after the engine, the transfer case, the front differential or the rear differential has been replaced.



Always obey applicable speed limits.

▼ Driving instructions

Drive sensibly – save fuel

Fuel consumption, to a great extent, depends on driving habits and operating conditions.

To save fuel you should:

- Keep tires at the recommended inflation pressures.
- Remove unnecessary loads.
- Remove roof rack when not in use.
- Allow engine to warm up under low load use.
- Avoid frequent acceleration and deceleration.
- Have all maintenance work performed at the intervals specified in the Maintenance Booklet and as required by the Maintenance System (U.S. vehicles) or FSS (Canada vehicles). Contact an authorized Mercedes-Benz Light Truck Center.

Fuel consumption is also increased by driving in cold weather, in stop-and-go traffic, on short trips and in hilly areas.

Drinking and driving

Warning!



Drinking and driving and/or taking drugs and driving are a very dangerous combination. Even a small amount of alcohol or drugs can affect your reflexes, perceptions and judgment.

The possibility of a serious or even fatal accident are greatly increased when you drink or take drugs and drive.

Do not drink or take drugs and drive or allow anyone to drive who has been drinking or taking drugs.

Operation

Driving instructions

Pedals

Warning!



Keep driver's foot area clear at all times. Objects stored in this area may impair pedal movement.

Power assistance

Warning!



With the engine is not running, there is no power assistance for the brake and steering systems. In this case, it is important to keep in mind that a considerably higher degree of effort is necessary to brake and steer the vehicle.

Operation

Driving instructions

Brakes

Warning!



After driving in heavy rain for some time without applying the brakes or through water deep enough to wet brake components, the first braking action may be somewhat reduced and increased pedal pressure may be necessary to obtain expected braking effect. Maintain a safe distance from vehicles in front.

Resting your foot on the brake pedal will cause excessive and premature wear of the brake pads.

It can also result in the brakes overheating, thereby significantly reducing their effectiveness. It may not be possible to stop the vehicle in sufficient time to avoid an accident.

To help prevent brake disk corrosion after driving on wet road surfaces (particularly salted roads), it is advisable to brake the vehicle with considerable force prior to parking. The heat generated serves to dry the brakes.

If your brake system is normally only subjected to moderate loads, you should occasionally test the effectiveness of the brakes by applying above-normal braking pressure at higher speeds. This will also enhance the grip of the brake pads.



Be very careful not to endanger other road users when you apply the brakes.

Refer to the description of the Brake Assist System (BAS) (▷ page 95).

If the parking brake is released and the brake warning lamp in the instrument cluster stays on and there is no audible warning (EBP), the brake fluid level in the reservoir is too low.

Brake pad wear or a leak in the system may be the reason for low brake fluid in the reservoir.

Have the brake system inspected immediately. Contact an authorized Mercedes-Benz Light Truck Center.

All checks and service work on the brake system should be carried out by qualified technicians only. Contact an authorized Mercedes-Benz Light Truck Center.

Only install brake pads and brake fluid recommended by Mercedes-Benz.

Warning!



If other than recommended brake pads are installed, or other than recommended brake fluid is used, the braking properties of the vehicle can be degraded to an extent that safe braking is substantially impaired. This could result in an accident.



When driving down long and steep grades, relieve the load on the brakes by shifting into a lower gear to use the engine's braking power. This helps prevent overheating of the brakes and reduces brake pad wear.

After hard braking, it is advisable to drive on for some time, rather than immediately park, so that the air stream will cool down the brakes faster.

Driving off

Apply the brakes to test them briefly after driving off. Perform this procedure only when the road is clear of other traffic.

Warm up the engine smoothly. Do not place full load on the engine until the operating temperature has been reached.

When starting off on a slippery surface, do not allow a drive wheel to spin for an extended period with the ESP[®] switched off. Doing so may cause serious damage to the drivetrain which is not covered by the Mercedes-Benz Limited Warranty.



Simultaneously depressing the accelerator pedal and applying the brake reduces engine performance and causes premature brake and drivetrain wear.

Parking



Set the parking brake whenever parking or leaving the vehicle. In addition, move gear selector lever to position **P**.

When parking on hills, always turn front wheels towards the curb.

Operation

Driving instructions

Warning!



To reduce the risk of personal injury, or damage to the vehicle powertrain, as a result of vehicle/trailer movement, before turning off the engine and leaving the vehicle always:

- Keep right foot on brake pedal.
- Firmly depress parking brake pedal.
- Shift the automatic transmission to position **P**.
- Slowly release brake pedal and let vehicle and trailer roll into chocks until stopped.
- When parked on an incline, turn front wheel towards the road curb.
- Have a second person place wheel chocks on downhill side of left and right trailer wheels.



Operation

Driving instructions

- ▷▷ Turn the SmartKey to starter switch position **0** and remove, or press KEYLESS-GO* start/stop button (vehicles with KEYLESS-GO*).
- Take the SmartKey or the SmartKey with KEYLESS-GO* with you and lock vehicle when leaving.

Tires

Warning!



If you feel a sudden significant vibration or ride disturbance, or you suspect that possible damage to your vehicle has occurred, you should turn on the hazard warning flashers, carefully slow down, and drive with caution to an area which is a safe distance from the road.

Inspect the tires and the vehicle underbody for possible damage. If the vehicle or tires appear unsafe, have it towed to the nearest Mercedes-Benz Light Truck Center or tire dealer for repairs.

Treadwear indicators (TWI) are required by law. These indicators are located in six places on the tread circumference and become visible at a tread depth of approximately $\frac{1}{16}$ in (1.6 mm), at which point the tire is considered worn and should be replaced.

The treadwear indicator appears as a solid band across the tread.

Warning!



Although the applicable federal motor vehicle safety laws consider a tire to be worn when the treadwear indicators (TWI) become visible at approximately $\frac{1}{16}$ in (1.6 mm), we recommend that you do not allow your tires to wear down to that level. As tread depth approaches $\frac{1}{8}$ in (3 mm), the adhesion properties on a wet road are sharply reduced.

Depending upon the weather and/or road surface (conditions), the tire traction varies widely.

Specified tire inflation pressures must be maintained. This applies particularly if the tires are subjected to high loads (e.g. high speeds, heavy loads, high ambient temperatures).

Warning!



Do not drive with a flat tire. A flat tire affects the ability to steer or brake the vehicle. You may lose control of the vehicle. Continued driving with a flat tire or driving at high speed with a flat tire will cause excessive heat build-up and possibly a fire.

For more information, see “Tires and wheels” (▷ page 335).

Operation

Driving instructions

Hydroplaning

Depending on the depth of the water layer on the road, hydroplaning may occur, even at low speeds and with new tires. Reduce vehicle speed, avoid track grooves in the road and apply brakes cautiously in the rain.

Tire traction

The safe speed on a wet, snow covered or icy road is always lower than on a dry road.

You should pay particular attention to the condition of the road whenever the outside temperatures are close to the freezing point.

Warning!



If ice has formed on the road, tire traction will be substantially reduced. Under such weather conditions, drive, steer and brake with extreme caution.

Mercedes-Benz recommends winter tires with a minimum tread depth of approximately $\frac{1}{6}$ in (4 mm) on all four wheels for the winter season to make sure normal balanced handling characteristics. On packed snow, they can reduce your stopping distance compared to summer tires.

Stopping distance, however, is still considerably greater than when the road is not covered with snow or ice. Exercise appropriate caution.



Avoid spinning of a drive wheel. This may cause serious damage to the drivetrain which is not covered by the Mercedes-Benz Limited Warranty.

For more information, see “Tires and wheels” (▷ page 335).

Tire speed rating

Regardless of the tire speed rating, local speed limits should be obeyed. Use prudent driving speeds appropriate to prevailing conditions.

Warning!



Even when permitted by law, never operate a vehicle at speeds greater than the maximum speed rating of the tires.

Exceeding the maximum speed for which tires are rated can lead to sudden tire failure, causing loss of vehicle control and possibly resulting in an accident and/or serious injury and possible death, for you and for others.

Operation

Driving instructions

ML 350 ML 500

Your vehicle is factory equipped with “H”-rated tires, which have a speed rating of 130 mph (210 km/h).

An electronic speed limiter prevents your vehicle from exceeding a speed of 130 mph (210 km/h).

ML 350 (with Sport Package*) ML 500 (with Sport Package*)

Your vehicle is factory equipped with “W”-rated tires, which have a speed rating of 168 mph (270 km/h).

An electronic speed limiter prevents your vehicle from exceeding a speed of 130 mph (210 km/h).



For information on speed ratings for winter tires, see “Winter tires” (▷ page 369).

For additional general information on tire speed markings on tire sidewall, see “Tire speed rating” (▷ page 367).

Winter driving instructions

The most important rule for slippery or icy roads is to drive sensibly and to avoid abrupt acceleration, braking and steering maneuvers. Do not use the cruise control system under such conditions.

When the vehicle is in danger of skidding, move gear selector lever to position **N**. Try to keep the vehicle under control by corrective steering action.



For information on driving with snow chains, see “Snow chains” (▷ page 370).

Warning!



On slippery road surfaces, never downshift in order to obtain braking action. This could result in drive wheel slip and reduced vehicle control. Your vehicle’s ABS will not prevent this type of control loss.

Road salts and chemicals can adversely affect braking efficiency. Increased pedal force may become necessary to produce the normal brake effect.

Depressing the brake pedal periodically when traveling at length on salt-strewn roads can bring road-salt-impaired braking efficiency back to normal.

If the vehicle is parked after being driven on salt-treated roads, the braking efficiency should be tested as soon as possible after driving is resumed.

Warning!



Make sure not to endanger any other road users when carrying out these braking maneuvers.

Warning!



If the vehicle becomes stuck in snow, make sure that snow is kept clear of the exhaust pipe and from around the vehicle with the engine running. Otherwise, deadly carbon monoxide (CO) gases may enter vehicle interior resulting in unconsciousness and death.

To assure sufficient fresh air ventilation, open a window slightly on the side of the vehicle not facing the wind.

Warning!



The outside temperature indicator is not designed to serve as an ice-warning device and is therefore unsuitable for that purpose. Indicated temperatures just above the freezing point do not guarantee that the road surface is free of ice.

For more information, see “Winter driving” (▷ page 369).

Standing water



Do not drive through flooded areas or water of unknown depth. Before driving through water, determine its depth. Never accelerate before driving into water. The bow wave could force water into the engine and auxiliary equipment, thus damaging them.

If you must drive through standing water, drive slowly to prevent water from entering the passenger compartment or the engine compartment. Water in these areas could cause damage to electrical components or wiring of the engine or transmission, or could result in water being ingested by the engine through the air intake, causing severe internal engine damage. Any such damage is not covered by the Mercedes-Benz Limited Warranty.

For more information, see “Driving through water” (▷ page 310).

Operation

Driving instructions

Off-road driving

Warning!



Drive slowly in unknown terrain. This will make it easier to recognize unexpected obstacles and avoid damage to the vehicle.

To help avoid the vehicle rolling over, never turn it around on steep inclines. If the vehicle cannot complete the attempted climb, back it down in reverse gear.

Do not drive along the side of a slope (danger of vehicle rollover). The vehicle might otherwise rollover. If in doing so the vehicle begins to show a tendency to roll, immediately steer into a line of gravity (straight up or downhill).

Never let the vehicle roll backwards in idle. You may lose control of the vehicle if you use only the service brake.

Warning!



Sand, dirt, mud and other material having friction property can cause exceptional wear and tear as well as brake failure.

Have the brakes checked for dirt build-up and cleaned. There is otherwise a risk that full braking power may not be available in an emergency.

Read this chapter carefully before you begin off-road travel.

Familiarize yourself with the vehicle characteristics and gear changing before you attempt any difficult terrain off-road driving. We recommend that you start out with easy off-road travel.

Special driving features for off-road driving

The following driving features are available for specific kind of operation:

- Off-road – ABS (▷ page 94)
- Off-road – ESP[®] (▷ page 98)
- Off-road – 4-ETS (▷ page 99)
- Start-off assist system (▷ page 191)
- Downhill Speed Regulation (DSR) (▷ page 243)
- Off-road driving program (▷ page 248)
- Air suspension* (▷ page 249)

Off-road driving rules

- Engage the Off-road driving program (▷ page 248) before driving under off-road conditions.
- If equipped with vehicle level control*, make sure you select a vehicle level appropriate to the topographical conditions. Always make sure the vehicle has enough ground clearance.
- Fasten items being carried as securely as possible (▷ page 259).
- Always navigate gradients with the engine on and with the transmission engaged in a gear. Switch on the DSR (▷ page 245) to help maintain a preset speed.



We recommend keeping doors, tailgate, windows, and tilt/sliding sunroof* closed whenever driving in off-road mode.



Observe the following during off-road driving:

- Adjust vehicle speed to condition of terrain. The more uneven, rutty and steeper the terrain, the lower the speed should be.
- Watch out for obstacles, such as rocks, holes, tree stumps and ruts.
- Be especially careful when driving in unknown territory. It may be necessary to get out of the vehicle and scout the path you intend to take.
- Before driving through water, determine its depth.
- Do not stop vehicle while immersed in water, and do not shut off the engine.

- In sandy soil, please drive at a steady speed as allowed by conditions. This helps overcome the vehicle rolling resistance and reduces the likelihood of the vehicle sinking into the ground.
- Do not initiate jumps with the vehicle. It interrupts the forward momentum of the vehicle.
- Always drive onto slopes with the engine running and the vehicle in gear.

Checklist before off-road driving

Engine oil level

- Check the engine oil level with the control system (ML 500 only) (▷ page 328), or with the oil dipstick (ML 350 only) (▷ page 330).

Only with a proper oil level can the vehicle obtain a trouble-free oil supply, even on steep gradients.

Operation

Driving instructions

Tires

- Check the tread depth and maintain specified tire inflation pressure (a placard with the recommended tire inflation pressures is located on the driver's door B-pillar).
- Check tires for possible damage and remove foreign objects.
- Replace missing valve caps.

Rims

- Dented or bent rims can cause tire inflation pressure loss and damage the tire beads. For this reason, check and, if necessary, change rims before driving off-road.

Vehicle tool kit

- Check if the vehicle jack is functional.
- In all cases take the vehicle tool kit, a strong tow rope, a shovel and a small plank (to put under the vehicle jack on sandy soil) with you.

Driving in steep terrain



Slope angle

- ① Overhang angle, front
- ② Overhang angle, rear

Vehicle with steel suspension	①	②
	31°	29°

Vehicle with Air suspension package*	①	②
Raised level	34°	31°
Highway	29°	26°

- Switch to Off-road driving program (▷ page 248) before starting to drive up or down steep inclines.
- Driving on embankments, slopes and other steep inclines should only be done straight up or downhill, i.e. in the line of gravity. Maximum vehicle climbing ability is a 100% grade which is equivalent to a slope angle of 45 degrees. Keep in mind that the climbing ability of the vehicle depends on terrain conditions.
- Do not drive along the side of a slope (danger of vehicle rollover). If in doing so the vehicle begins to show a tendency to roll, immediately steer into a line of gravity (straight up or downhill).

- To help avoid the vehicle rolling over, never turn it around on steep inclines. If the vehicle cannot complete the attempted climb, back it down in reverse gear. Switch on the DSR (▷ page 245) to help maintain a speed when driving downhill.
- Utilize the engine's braking power when descending a slope, observe the engine speed (do not overrev the engine). Apply the service brake as needed.
- Check the brakes after a lengthy downgrade drive.



Avoid excessive engine speeds – drive with moderate engine speeds (max. 3000 rpm).

Select gear range **2** or **1** on the automatic transmission (▷ page 187).

Traction in steep terrain

- Be easy on the accelerator and watch for continuous wheel traction when driving in steep terrain.

The 4-ETS helps greatly when starting out on a steep incline when the front wheels have then the tendency to slip due to the weight shifting towards the rear axle.

The 4-ETS recognizes the situation and limits the torque for the front wheels by braking them. Simultaneously the torque for the rear wheels is increased.

Driving across a hilltop

- Decelerate just ahead of a hilltop (do not select gear range **N**), to prevent the vehicle from speeding up too much after climbing a hill.

Use the momentum of the vehicle to drive across the hilltop.

Driving in this manner allows the vehicle to maintain ground contact when cresting hills.

Operation

Driving instructions

Driving downhill

- Select gear range **1** on the automatic transmission (▷ page 187).
- Drive downhill observing the same rules as driving uphill (▷ page 308).
- On steep inclines, use the Downhill Speed Regulation (▷ page 243).
- Drive slowly.
- Do not drive at an angle to the incline. Steer into the line of gravity and drive with the front wheels pointing straight downhill. Otherwise, the vehicle may slide sideways off the path and roll over.
- Utilize the engine's braking power to reduce vehicle speed.
If this is insufficient, apply the brake gently. Make sure the vehicle is moving in the line of gravity.
- Check the brakes after a lengthy downgrade drive.

Driving through water



① Fording depth

Vehicles with steel suspension	①
	20 in (50 cm)

Vehicles with Air suspension package*	①
Raised level	20 in (50 cm)

- Before driving through water, determine its depth.
It should not be deeper than approximately 20 inches (50 cm).
Make sure you check the water bed. The ground surface may not be firm which may result in deeper waters than expected when driving the vehicle through it.
- For vehicles with level control*, raise the ride height (▷ page 250) if necessary.
- Switch to the Off-road driving program (▷ page 248) before driving through water.
- Select gear range **1** or **2** on the automatic transmission (▷ page 187).
- Avoid high engine speeds.
- Drive through the water slowly and at a constant speed.

- Switch off the exterior lamps as well as the automatic climate control.
- Enter the water only at a shallow spot, driving at walking speed.



Never accelerate before driving into the water. The bow wave could force water into the engine and auxiliary equipment, thus damaging them.

- Do not stop vehicle while immersed in water, and do not shut off the engine.

There is a very high level of driving resistance in water. The surface is slippery and may not be firm, making pulling away in water difficult and dangerous.

- Clean mud off the tire tread after driving through water.
- To dry the brakes, apply pressure to the brake pedal several times after leaving the water.

Crossing obstacles



Obstacles can damage the vehicle underbody or suspension components. If possible use the assistance of a second person outside the vehicle to scout the path you intend to take and check for adequate ground clearance when you cross obstacles with your vehicle. The person assisting you outside the vehicle should always be a safe distance away from the vehicle and positioned so that he or she cannot get hurt in case of any unexpected vehicle movement.

After off-road driving or crossing obstacles, inspect vehicle for any damage, especially vehicle underbody and suspension components. Failure to do so can adversely affect the vehicle's future performance, including increased chance of an accident.

Operation

Driving instructions

When driving over tree stumps, big rocks and other obstacles, observe the following rules:

- Make sure the Off-road driving program (▷ page 248) is switched on.
- Avoid high engine speeds.
- Select gear range **1** on the automatic transmission (▷ page 187).
- Check the vehicle clearance before crossing obstacles.
- Cross obstacles (e.g. tree stumps or big rocks) very slowly by aiming one of the front wheels at the center of the obstacle, and repeat same with the rear wheel.



Special attention is needed when you cross obstacles on a steep incline.

The vehicle could slide sideways as a result of its possible slanted position which in turn may result in the vehicle tipping or rolling over.

Driving on sand

- For vehicles with level control*, raise the ride height (▷ page 250) if necessary.
- Avoid high engine speeds.
- Select the gear range on the automatic transmission that is appropriate for the terrain.
- In sandy soil, drive at a steady speed as allowed by conditions. This helps overcome the vehicle rolling resistance and reduce the likelihood of the vehicle sinking into the ground.
- Drive in tracks of other vehicles if they are not too deep and if you have sufficient clearance.

Ruts

A number of off-road tracks or other by-ways have deep ruts which can cause the underbody to come in contact with the ground.

- Switch on the Off-road driving program (▷ page 248).
- For vehicles with level control*, raise the ride height (▷ page 250) if necessary.



Check that the ruts are not too deep and your vehicle's clearance is sufficient. Otherwise:

- your vehicle may be damaged.
- the underbody of the vehicle may come in contact with the ground and you may get stuck.
- Avoid high engine speeds.
- Select gear range **1** on the automatic transmission (▷ page 187).
- Drive next to the ruts rather than through them if at all possible.
- If the ruts are too deep to drive in, drive with one side of the vehicle on the grassy center strip if the route permits.

Returning from off-road driving

Warning!



If you feel a sudden significant vibration or ride disturbance, or you suspect that possible damage to your vehicle has occurred, you should turn on the hazard warning flashers, carefully slow down, and drive with caution to an area which is a safe distance from the roadway.

Inspect the tires and under the vehicle for possible damage. If the vehicle or tires appear unsafe, have it towed to the nearest Mercedes-Benz Light Truck Center or tire dealer for repairs.

Off-road driving increases strain on the vehicle.

We recommend that you inspect the vehicle for possible damage after each off-road trip. Recognizing any damage and a subsequent timely repair reduces the chance of a possible breakdown or accident later on.

Proceed as follows:

- Switch off the Off-road driving program (▷ page 248).
- Switch off the DSR (▷ page 245).
- Remove excessive dirt from tires, wheels, wheel housings, and underbody.

For instance, after driving in mud, clean the radiator, chassis, engine, brakes, and wheels from extreme dirt using a strong jet of water.

- Inspect vehicle underbody, oil pan, brake hoses, etc., as well as vehicle underbody for possible damage.
- Check tires for possible damage, clean all exterior lamps, and conduct a brake test.
- Check for brush or branches caught in the underbody.

They could increase the possibility of a fire, as well as cut fuel and/or brake lines, puncture rubber bellows of the axles or drive shafts.
- After continued operation in mud, sand, water or other dirty conditions clean the brake discs, wheels, brake pads and check and clean axle joints.

Operation

Driving instructions

Trailer towing

Warning!



Failure to use proper equipment and driving technique can result in a loss of vehicle control when towing a trailer.

Improper towing or failure to follow the instructions contained in this guide can result in vehicle damage and/or serious personal injury. Follow the guidelines below carefully to assure safe trailer operation.

Ask an authorized Mercedes-Benz Light Truck Center should you require an explanation of information contained in this guide.

Trailer hitches*

- Only install a trailer hitch receiver approved for your vehicle.
For information on availability and installation, see an authorized Mercedes-Benz Light Truck Center.
- The bumpers on your vehicle are not designed for use with clamp-type hitches.
Do not attach rental hitches or other bumper-type hitches to them.
- To reduce the possibility of damage, remove the hitch ball adaptor from the receiver when not in use.

Electrical connections

The vehicle is prewired to accept the seven-wire harness included in the Mercedes-Benz approved trailer hitch receiver kit.

An additional four-pole conversion plug is included in the Mercedes-Benz supplied trailer hitch receiver kit.

For further information, see an authorized Mercedes-Benz Light Truck Center.

Vehicle and trailer weights and ratings

Gross Vehicle Weight Rating (GVWR) is the maximum permissible vehicle weight: 6240 lbs (2830 kg).

Gross Vehicle Weight (GVW): Comprises weight of vehicle including fuel, tools, spare wheel, installed accessories, passengers, cargo and trailer tongue. It must never exceed the GVWR.

Gross Axle Weight Rating (GAWR) is the maximum permissible axle weight:

	ML 350	ML 500
Front	2945 lbs (1335 kg)	2985 lbs (1355 kg)
Rear	3295 lbs (1495 kg)	3255 lbs (1475 kg)

The **Gross Trailer Weight (GTW)** is the weight of the trailer plus the weight of all cargo, equipment, luggage etc. loaded on the trailer. The maximum permissible gross trailer weight to be towed: 5000 lbs (2260 kg).

Trailer Tongue Weight Rating (TWR) is the maximum permissible weight on the trailer tongue: 500 lbs (225 kg) limit for Mercedes-Benz approved hitch receiver.

Loading a trailer

- When loading a trailer, you should observe that neither the permissible GTW, nor the GVWR are exceeded.
Maximum permissible values are listed on the safety compliance certification labels for the vehicle and for the trailer to be towed. The lowest value listed must be selected when determining how the vehicle and trailer are loaded.
- The tongue weight at the hitch ball must be added to the GVW to prevent exceeding your Mercedes-Benz tow vehicle’s rear GAWR.

Operation
Driving instructions



We recommend loading the trailer in such a manner that it has a tongue weight (TW) between 10% and 15% of the GTW.

Checking weights of vehicle and trailer

- To assure that the tow vehicle and trailer are in compliance with the maximum permissible weight limits have the loaded rig (tow vehicle including driver, passengers and cargo, trailer fully loaded) weighed on a commercial scale.
- Check the vehicle’s front and rear Gross Axle Weight (GAW), the GTW and TW.
The values as measures must not exceed the weight limits listed under “Vehicle and trailer weight and ratings” (▷ page 315).

Operation

Driving instructions

Attaching a trailer

Observe maximum permitted trailer dimensions (width and length).

Most states and all Canadian provinces require

- safety chains between your tow vehicle and the trailer.

The chains should be criss-crossed under the trailer tongue. They must be attached to the hitch receiver, and not to the vehicle's bumper or axle.

Make sure to leave enough slack in the chains to permit turning corners.

- a separate brake system at various trailer weights.
- a break-away switch on trailers with a separate brake system.

The switch activates the trailer brakes in the possible event that the trailer might separate from the tow vehicle.



Do not connect a trailer brake system (if trailer is so equipped) directly to the vehicle's hydraulic brake system, as your vehicle is equipped with antilock brakes. If you do, neither the vehicle's brakes nor the trailer's brakes will function properly.



The provided vehicle electrical wiring harness for trailer towing has a brake signal wire (color orange) for hook-up to a brake controller.

You should consider using a trailer sway control system. For further information see an authorized Mercedes-Benz Light Truck Center.

- ▶ Start the engine (▷ page 34).
- ▶ Make sure the automatic transmission is set to **P**.

- ▶ Set the parking brake for the vehicle (▷ page 52).
- ▶ Vehicles with ADS*: Set the vehicle level to Highway (▷ page 250).
- ▶ Vehicle with ADS*: Set the ADS* to AUTO or COMFORT (▷ page 249).
- ▶ Stop the engine (▷ page 34).
- ▶ Attach the trailer.

Warning!



Vehicles with ADS*:

Do not lock or unlock any doors or the tailgate while attaching or uncoupling the trailer. Do not open or close any doors or the tailgate while attaching or uncoupling the trailer. Make sure no one operates the ADS* switch (▷ page 249) or the vehicle level control* switch (▷ page 252) while a trailer is being attached or uncoupled. The vehicle level could change, and you could injure yourself and/or others.

- ▶ Plug in all electrical connectors.



When you are towing a trailer, the vehicle level always remains in the Highway setting.

Towing a trailer

There are many different laws, including speed limit restrictions, having to do with trailer towing. Make sure your rig will be legal, not only for where you reside, but also for where you will be driving. A good source for this information can be the police or local authorities.

Note the following points, when driving with the trailer:

- In order to gain skill and an understanding of the vehicle's behavior, you should practice turning, stopping and backing up in an area which is free from traffic.

- Before you start driving check the
 - trailer hitch
 - break-away switch
 - safety chains
 - electrical connections
 - lighting and tires

Adjust the mirrors to permit unobstructed view beyond rear of trailer.

- If the trailer has electric brakes, start your vehicle and trailer moving slowly, and then apply only the trailer brake controller by hand to make sure the brakes are working properly.
- Always secure items in the trailer to prevent load shifts while driving.
- When towing a trailer, check occasionally to make sure the load is secure, and that lighting and trailer brakes (if so equipped) are functioning properly.

- Take into consideration that when towing a trailer, the handling characteristics are different and less stable from those when operating the vehicle without a trailer.

It is important to avoid sudden maneuvers.

- The vehicle and trailer combination is heavier, and therefore is limited in acceleration and climbing ability, and requires longer stopping distances.

It is more prone to reacting to cross wind gusts, and requires more sensitive steering input.

- If possible, do not brake abruptly, but rather engage the brake slightly at first to permit the trailer to activate its brake. Then increase the braking force.

Operation

Driving instructions



If the trailer should begin to sway, reduce the vehicle's speed immediately.

In no case attempt to straighten out the tow vehicle and trailer by increasing the speed.

- If the transmission hunts between gears on inclines, manually shift to a lower gear (select **4**, **3**, **2** or **1**).

A lower gear and reduction of speed reduces the chance of engine overloading and/or overheating.

- On very steep inclines, not manageable with automatic transmission in **1**, switch on off-road driving program (▷ page 248).

- When going down a long hill, shift into a lower gear and use the engine's braking effect.

Avoid riding the brakes, thus overheating the vehicle and trailer brakes.

- If the engine coolant rises to an extremely high temperature (coolant temperature needle approaching the red zone) when the air conditioning is on, turn off the air conditioning system.

Engine coolant heat can be additionally vented by opening the windows, switching the climate control fan speed to high and setting the temperature control to the maximum hot position.

- Extreme care must be exercised since your vehicle with a trailer will require additional passing distance ahead than when driving without a trailer.

Because your vehicle and trailer is longer than your vehicle alone, you will also need to go much farther ahead of the passed vehicle before you can return to your lane.

Uncoupling the trailer

- ▶ Start the engine (▷ page 34).
- ▶ Make sure the automatic transmission is set to **P**.
- ▶ Set the parking brake for the vehicle (▷ page 52) and for the trailer.
- ▶ Close all doors and the tailgate.
Detach the trailer immediately afterward as follows:
 - ▶ Disconnect all electrical plug connectors.
 - ▶ Uncouple the trailer.

Warning!



As soon as you disconnect the electrical connection between the trailer and the vehicle, the vehicle will lower. To help avoid personal injury, make sure no one is near the wheel housing or underneath the vehicle before the electrical connection is disconnected.

When you uncouple the trailer, the vehicle is temporarily raised because the springs are relieved of load. Be especially careful during this process, as you could otherwise injure yourself and/or others. Make sure that any persons remaining in the vehicle do not press the switches for vehicle level control* or the ADS*.

- ▶ Make sure that the trailer coupling is free of load.
- ▶ Stop the engine (▷ page 34).

Passenger compartment

Warning!



Always fasten items being carried as securely as possible.

In an accident, during hard braking or sudden maneuvers, loose items will be thrown around inside the vehicle, and cause injury to vehicle occupants unless the items are securely fastened in the vehicle.

The rear cargo compartment is the preferred place to carry objects. Always use the partition net when transporting cargo. Partition net cannot secure hard or heavy objects. Always fasten items being carried as securely as possible using the cargo tie-down rings in the cargo floor area and fastening materials.

Driving abroad

Abroad, there is an extensive Mercedes-Benz service network at your disposal. If you plan to drive into areas which are not listed in the index of your Mercedes-Benz Light Truck Center directory, you should request pertinent information from an authorized Mercedes-Benz Light Truck Center.

Operation

Driving instructions

Control and operation of radio transmitters

Modular COMAND System, radio and telephone*

Warning!



Do not forget that your primary responsibility is to drive the vehicle. Only operate the Modular COMAND System, radio or telephone¹ if road, weather and traffic conditions permit.

Bear in mind that at a speed of just 30 mph (approximately 50 km/h), your vehicle is covering a distance of 44 feet (approximately 14 m) every second.

¹ Observe all legal requirements.

Telephones and two-way radios

Warning!



Never operate radio transmitters equipped with a built-in or attached antenna (i.e. without being connected to an external antenna) from inside the vehicle while the engine is running. Doing so could lead to a malfunction of the vehicle's electronic system, possibly resulting in an accident and/or personal injury.

Radio transmitters, such as a portable telephone or a citizens band unit should only be used inside the vehicle if they are connected to an antenna that is installed on the outside of the vehicle.

Refer to the radio transmitter operation instructions regarding use of an external antenna.

Catalytic converter

Your Mercedes-Benz is equipped with monolithic-type catalytic converters, an important element in conjunction with the oxygen sensors to achieve substantial control of the pollutants in the exhaust emissions. Keep your vehicle in proper operating condition by following our recommended maintenance instructions as outlined in your Maintenance Booklet.



To prevent damage to the catalytic converters, use only premium unleaded gasoline in this vehicle.

Any noticeable irregularities in engine operation should be repaired promptly. Otherwise, excessive unburned fuel may reach the catalytic converter, causing it to overheat and potentially start a fire.

Warning!



As with any vehicle, do not idle, park or operate this vehicle in areas where combustible materials such as grass, hay or leaves can come into contact with the hot exhaust system, as these materials could be ignited and cause a vehicle fire.

Emission control

Certain systems of the engine serve to keep the toxic components of the exhaust gases within permissible limits required by law.

These systems, of course, will function properly only when maintained strictly according to factory specifications. Any adjustments on the engine should, therefore, be carried out only by qualified Mercedes-Benz Light Truck Center authorized technicians. Engine adjustments should not be altered in any way. Moreover, the specified service jobs must be carried out regularly according to Mercedes-Benz servicing requirements. For details refer to the Maintenance Booklet.

Warning!



Inhalation of exhaust gas is hazardous to your health. All exhaust gas contains carbon monoxide, and inhaling it can cause unconsciousness and lead to death.

Do not run the engine in confined areas (such as a garage) which are not properly ventilated. If you think that exhaust gas fumes are entering the vehicle while driving, have the cause determined and corrected immediately. If you must drive under these conditions, drive only with at least one window fully open at all times.

Operation

Driving instructions

Coolant temperature

During severe operating conditions, e.g. stop-and-go traffic, the coolant temperature may rise close to approximately 248°F (120°C).

The engine should not be operated with the coolant temperature over 248°F (120°C). Doing so may cause serious engine damage which is not covered by the Mercedes-Benz Limited Warranty.

Warning!



- Driving when your engine is badly overheated can cause some fluids, which may have leaked into the engine compartment to catch fire. You could be seriously burned.
- Steam from an overheated engine can cause serious burns and can occur just by opening the engine hood. Stay away from the engine if you see or hear steam coming from it.

Turn off the engine, get out of the vehicle and do not stand near the vehicle until the engine has cooled down.

▼ At the gas station

Refueling

Warning!



Gasoline is highly flammable and poisonous. It burns violently and can cause serious injury. Whenever you are around gasoline, avoid inhaling fumes and skin contact, extinguish all smoking materials. Never allow sparks, flame or smoking materials near gasoline!

The fuel filler flap is located on the right-hand side of the vehicle towards the rear. Locking/unlocking the vehicle with the SmartKey or the SmartKey with KEYLESS-GO* automatically locks/unlocks the fuel filler flap.



- ▶ Turn the engine off
 - by turning the SmartKey to position **0**. Remove the SmartKey from the starter switch.
 - by pressing the KEYLESS-GO* start/stop button (▷ page 35). Open the driver's door (with the driver's door open, starter switch is now in position **0**, same as SmartKey removed from starter switch).
- ▶ Open the fuel filler flap by pushing at the point indicated by the arrow.
The fuel filler flap springs open.

Operation

At the gas station

- ▶ Turn the fuel cap to the left and hold on to it until possible pressure is released.
- ▶ Take off the cap.
To prevent fuel vapors from escaping into open air, fully insert filler nozzle unit.
- ▶ Only fill your tank until the filler nozzle unit cuts out - **do not top up or overfill**.

Warning!



Overfilling of the fuel tank may create pressure in the system which could cause a gas discharge. This could cause the gas to spray back out when removing the fuel pump nozzle, which could cause personal injury. ▷▷

Operation

At the gas station

- ▷▷ Replace the fuel cap by turning it clockwise until it audibly engages.
- ▷ Close the fuel filler flap.





Only use premium unleaded gasoline with a minimum Posted Octane Rating of 91 (average of 96 RON/86 MON). Information on gasoline quality can normally be found on the fuel pump.

For more information on gasoline, see the Factory Approved Service Products pamphlet.



Leaving the engine running and the fuel cap open can cause the yellow engine malfunction indicator lamp

 (USA only),  (Canada only) to illuminate.

For more information, see “Practical hints” (▷ page 385).

Check regularly and before a long trip

- ▷ Open the hood (▷ page 326).



Example ML 500

- ① Brake fluid
- ② Coolant level
- ③ Windshield washer system and headlamp cleaning system*

Engine oil level

For more information on engine oil, see “Engine oil” (▷ page 327).

Brake fluid



If you find that the brake fluid in the brake fluid reservoir has fallen to the minimum mark or below, have the brake system checked for brake pad thickness and leaks immediately. Notify an authorized Mercedes-Benz Light Truck Center immediately. Do not add brake fluid as this will not solve the problem. For more information, see “Practical hints” (▷ page 381).

Coolant

For normal replenishing, use water (potable water quality).

For more information, see “Coolant level” (▷ page 332) and see “Fuels, coolants, lubricants, etc.” (▷ page 493).

Windshield/rear window washer system and headlamp cleaning system*

For more information on refilling the washer reservoir, see “Windshield/rear window washer system and headlamp cleaning system*” (▷ page 333).

Vehicle lighting

Check function and cleanliness. For information on replacing light bulbs, see “Replacing bulbs” (▷ page 443).

For more information, see “Exterior lamp switch” (▷ page 138).

Tire inflation pressure

For more information, see “Checking tire inflation pressure” (▷ page 347).

Operation

Engine compartment

Hood

Warning!



Do not pull the release lever while the vehicle is in motion. Otherwise the hood could be forced open by passing air flow.

Opening

The hood lock release lever is located in the driver's footwell to the left of the parking brake pedal.



① Release lever

- ▶ Pull release lever ① downwards.

The hood is unlocked. Handle ② protrudes slightly from the radiator grille. If not, lift the hood slightly.



To avoid damage to the windshield wipers or hood, never open the hood if the wiper arms are folded forward away from the windshield.



② Handle for opening the hood

- ▶ Pull and hold handle ② in direction of arrow.

The hood is unlocked.

- ▶ Pull up on the hood and then release it.

The hood will be automatically held open at shoulder height by gas-filled struts.

Warning!



To help prevent personal injury, stay clear of moving parts when the hood is open and the engine is running. Make sure the hood is properly closed before driving. When closing the hood, use extreme caution not to catch hands or fingers.

The radiator fan may continue to run for approximately 30 seconds or even restart after the engine has been turned off. Stay clear of fan blades.

Operation

Engine compartment

Warning!



If you see flames or smoke coming from the engine compartment, or if the coolant temperature gauge indicates that the engine is overheated, do not open the hood. Move away from vehicle and do not open the hood until the engine has cooled. If necessary, call the fire department.

Warning!



The engine is equipped with a transistorized ignition system. Because of the high voltage it is dangerous to touch any components (ignition coils, spark plug sockets, diagnostic socket) of the ignition system

- with the engine running
- while starting the engine
- if ignition is “on” and the engine is turned manually

Closing

Warning!



Be careful that you do not close the hood on anyone.

- ▶ Let the hood drop from a height of approximately 1 ft (30 cm).
The hood will lock audibly.
- ▶ Check to make sure the hood is fully closed.

If you can raise the hood at a point above the headlamps, then it is not properly closed. Open it again and let it drop with somewhat greater force.

Engine oil

The amount of oil your engine needs will depend on a number of factors, including driving style. Higher oil consumption can occur when

- the vehicle is new
- the vehicle is driven frequently at higher engine speeds

Engine oil consumption checks should only be made after the vehicle break-in period.



Do not use any special lubricant additives, as these may damage the drive assemblies. Using special additives not approved by Mercedes-Benz may cause damage not covered by the Mercedes-Benz Limited Warranty.

More information on this subject is available at any Mercedes-Benz Light Truck Center.

Operation

Engine compartment



Checking engine oil level with the control system (ML 500 only)

When checking the oil level

- the vehicle must be parked on level ground
- with the engine at operating temperature, the vehicle must have been stationary for at least five minutes with the engine turned off
- with the engine not at operating temperature yet, the vehicle must have been stationary for at least 30 minutes with the engine turned off

To check the engine oil level via the multifunction display, do the following:

- ▶ Switch on the ignition (▷ page 34).
The standard display (▷ page 156) should appear in the multifunction display.



- ▶ Press button  or  on the steering wheel until the following message is seen in the multifunction display:



One of the following messages will subsequently appear in the multifunction display:

- Engine oil level ok
- Add 1.0 qt. to reach max. oil level
(Canada: 1.0 liter)
- Add 1.5 qts. to reach max. oil level
(Canada: 1.5 liters)
- Add 2.0 qts. to reach max. oil level
(Canada: 2.0 liters)



If you want to interrupt the checking procedure, press the  or  button on the multifunction steering wheel.

- ▶ If necessary, add engine oil.

For adding engine oil see (▷ page 495).

For more information on engine oil, see the “Technical data” section (▷ page 493) and (▷ page 495).

Other display messages

If the SmartKey or KEYLESS-GO* start/stop button is not in position **2**, the following message will appear:

Turn on ignition
to see engine oil level

- ▶ Switch on the ignition (▷ page 34).

If you see the message:

Observe waiting time

- ▶ If the engine is at operating temperature, wait five minutes before repeating check procedure.
- ▶ If the engine is not at operating temperature, wait 30 minutes before repeating check procedure.

If you see the message:

Engine oil level
Not when engine on

- ▶ Turn off the engine.
- ▶ If the engine is at operating temperature, wait five minutes before checking oil.
- ▶ If the engine is not at operating temperature yet, you must wait 30 minutes before checking oil.

If there is excess engine oil with the engine at operating temperature, the following message will appear:

Engine oil level
Reduce oil level

- ▶ Have excess oil siphoned or drained off. Contact an authorized Mercedes-Benz Light Truck Center.



Excess oil must be siphoned or drained off. It could cause damage to the engine and catalytic converter not covered by the Mercedes-Benz Limited Warranty.

For more information on messages in the multifunction display concerning engine oil, see “Practical hints” (▷ page 381).

Operation

Engine compartment

Checking engine oil level with the oil dipstick (ML 350 only)

When checking the oil level

- the vehicle must be parked on level ground
- with the engine at operating temperature, the vehicle must have been stationary for at least five minutes with the engine turned off
- with the engine not at operating temperature yet, the vehicle must have been stationary for at least 30 minutes with the engine turned off

To check the engine oil level with the oil dipstick, do the following:

- ▶ Open the hood (▷ page 326).



- ① Oil dipstick
- ② Upper mark
- ③ Lower mark

- ▶ Pull out oil dipstick ①.
- ▶ Wipe oil dipstick ① clean.
- ▶ Fully insert oil dipstick ① into the dipstick guide tube.
- ▶ Pull out oil dipstick ① again after approximately three seconds to obtain accurate reading.

The oil level is correct when it is between the lower ③ (min.) and upper ② (max.) mark of the oil dipstick.



The filling quantity between the upper and lower marks on the oil dipstick is approximately 2.1 US qt. (2.0 l).

- ▶ If necessary, add engine oil.

For adding engine oil, see (▷ page 331).

For more information on engine, see the “Technical data” section (▷ page 493) and (▷ page 495).

Operation

Engine compartment

Adding engine oil



Only use approved engine oils and oil filters required for vehicles with Maintenance System (U.S. vehicles) or FSS PLUS (Canada vehicles). For a listing of approved engine oils and oil filters, refer to the Factory Approved Service Products pamphlet in your vehicle literature portfolio, or contact an authorized Mercedes-Benz Light Truck Center.

In addition, check the oil filler cap for important information pertaining to the engine oil needing to meet a specific Mercedes-Benz specification (e.g. MB 229.5). If such information is printed on the oil filler cap, only use an engine oil from the list of approved engine oils in the Factory Approved Service Products pamphlet that meets the specification indicated on the oil filler cap.

Using engine oils and oil filters of specification other than those expressly required for the Maintenance System (U.S. vehicles) or FSS PLUS (Canada vehicles), or changing of oil and oil filter at change intervals longer than those called for by the Maintenance System (U.S. vehicles) or FSS PLUS (Canada vehicles) will result in engine damage not covered by the Mercedes-Benz Limited Warranty.



Example ML 500

① Filler cap



Example ML 350

① Filler cap

Operation

Engine compartment

- ▶ Unscrew filler cap ① from filler neck.
- ▶ Add engine oil as required. Be careful not to overfill with oil.

Be careful not to spill any oil when adding. Avoid environmental damage caused by oil entering the ground or water.



Excess oil must be siphoned or drained off. It could cause damage to the engine and catalytic converter not covered by the Mercedes-Benz Limited Warranty.

- ▶ Screw filler cap ① back on filler neck.

For more information on engine oil, see “Technical data” (▶ page 481).

Transmission fluid level

The transmission fluid level does not need to be checked. If you notice transmission fluid loss or gear shifting malfunctions, have an authorized Mercedes-Benz Light Truck Center check the automatic transmission.

Coolant level

The engine coolant is a mixture of water and anticorrosion/antifreeze. To check the coolant level, the vehicle must be parked on level ground and the engine must be cool.

Warning!



In order to avoid any possibly serious burns:

- Use extreme caution when opening the hood if there are any signs of steam or coolant leaking from the cooling system, or if the coolant temperature gauge indicates that the coolant is overheated.
- Do not remove pressure cap on coolant reservoir if coolant temperature is above 158°F (70°C). Allow engine to cool down before removing cap. The coolant reservoir contains hot fluid and is under pressure.
- Using a rag, slowly open the cap approximately $\frac{1}{2}$ turn to relieve excess pressure. If opened immediately, scalding hot fluid and steam will be blown out under pressure.
- Do not spill antifreeze on hot engine parts. Antifreeze contains ethylene glycol which may burn if it comes into contact with hot engine parts.

The coolant expansion tank is located on the driver's side of the engine compartment.



① Coolant expansion tank

▶ Using a rag, turn the cap slowly approximately one half turn to the left to release any excess pressure.

▶ Continue turning the cap to the left and remove it.

The coolant level is correct if the level

- for cold coolant: reaches the top of the indicator wall visible through the filling opening
- for warm coolant: is approximately 0.6 in (1.5 cm) higher

▶ Add coolant as required.

▶ Replace and tighten cap.

For more information on coolant, see the "Technical data" section (▷ page 497).

Windshield/rear window washer system and headlamp cleaning system*

The windshield washer reservoir is located in the engine compartment.



① Cap

Fluid for the windshield washer system and the headlamp cleaning system* is supplied from the windshield washer reservoir. It has a capacity of 8.1 US qt (7.7 l).

Operation

Engine compartment

During all seasons, add MB Windshield Washer Concentrate “S” to water. Premix the windshield washer fluid in a suitable container.

- ▶ Use the tab to pull cap ① upwards.
- ▶ Refill the reservoir with MB Windshield Washer Concentrate “S” and water (or commercially available premixed windshield washer solvent/antifreeze, depending on ambient temperatures).

Always use washer solvent/antifreeze where temperatures may fall below freezing point. Failure to do so could result in damage to the washer system/reservoir.



Only use washer fluid which is suitable for plastic lenses. Improper washer fluid can damage the plastic lenses of the headlamps.

Warning!



Washer solvent/antifreeze is highly flammable. Do not spill washer solvent/antifreeze on hot engine parts, because it may ignite and burn. You could be seriously burned.

For more information, see the “Technical data” section (▷ page 500).

▼ Tires and wheels

See an authorized Mercedes-Benz Light Truck Center for information on tested and recommended rims and tires for summer and winter operation. They can also offer advice concerning tire service and purchase.

Warning!



Replace rims or tires with the same designation, manufacturer and type as shown on the original part. See an authorized Mercedes-Benz Light Truck Center for further information. If incorrectly sized rims and tires are mounted:

- The wheel brakes or suspension components can be damaged.
- The operating clearance of the wheels and the tires may no longer be correct.

Warning!



Worn, old tires can cause accidents. If the tire tread is badly worn, or if the tires have sustained damage, replace them.

When replacing rims, only use genuine Mercedes-Benz wheel bolts specified for the particular rim type. Failure to do so can result in the bolts loosening and possibly an accident.

Retreaded tires are not tested or recommended by Mercedes-Benz, since previous damage cannot always be recognized on retreads. The operating safety of the vehicle cannot be assured when such tires are used.

Operation

Tires and wheels

Important guidelines

- Only use sets of tires and rims of the same type and make.
- Tires must be of the correct size for the rim.
- Break in new tires for approximately 60 miles (100 km) at moderate speeds.
- Regularly check the tires and rims for damage. Dented or bent rims can cause tire inflation pressure loss or damage to the tire beads.
- If vehicle is heavily loaded, check tire inflation pressure and correct as required.
- Do not allow your tires to wear down too far. Adhesion properties on wet roads are sharply reduced at tread depths under $\frac{1}{8}$ in (3 mm).
- When replacing individual tires, you should mount new tires on the front wheels first (on vehicles with same-sized wheels all around).

Operation

Tires and wheels

Tire care and maintenance

Warning!



Regularly check the tires for damage. Damaged tires can cause tire inflation pressure loss. As a result, you could lose control of your vehicle.

Worn, old tires can cause accidents. If the tire tread is badly worn, or if the tires have sustained damage, replace them.

Regularly check your tire inflation pressure at least once a month. For more information on checking tire inflation pressure see “Recommended tire inflation pressure” (▷ page 345).

Tire inspection

Every time you check your tire inflation pressure, you should also inspect your tires for the following:

- excessive treadwear (▷ page 337)
- cord or fabric showing through the tire’s rubber
- bumps, bulges, cuts, cracks or splits in the tread or side of the tire

Replace the tire if you find any of the above conditions.

Make sure you also inspect the spare tire periodically for condition and inflation. Spare tires will age and become worn over time even if never used, and thus should be inspected and replaced when necessary.

Life of tire

The service life of a tire is dependent upon varying factors including but not limited to:

- Driving style
- Tire inflation pressure
- Distance driven

Warning!



Tires and spare tire should be replaced after six years, regardless of the remaining tread.

Operation

Tires and wheels

Tread depth

Do not allow your tires to wear down too far. Adhesion properties on wet roads are sharply reduced at tread depths under $\frac{1}{8}$ in (3 mm).

Treadwear indicators (TWI) are required by law. These indicators are located in six places on the tread circumference and become visible at a tread depth of approximately $\frac{1}{16}$ in (1.6 mm), at which point the tire is considered worn and should be replaced.

Recommended minimum tire tread depth:

- Summer tires $\frac{1}{8}$ in (3 mm)
- Winter tires $\frac{1}{6}$ in (4 mm)

Warning!



Although the applicable federal motor safety laws consider a tire to be worn when the treadwear indicators (TWI) become visible at approximately $\frac{1}{16}$ in (1.6 mm), we recommend that you do not allow your tires

to wear down to that level. As tread depth approaches $\frac{1}{8}$ in (3 mm), the adhesion properties on a wet road are sharply reduced.

Depending upon the weather and/or road surface (conditions), the tire traction varies widely.



① TWI (Tread Wear Indicator)

The treadwear indicator appears as a solid band across the tread.

Storing tires



Keep unmounted tires in a cool, dry place with as little exposure to light as possible. Protect tires from contact with oil, grease and gasoline.

Cleaning tires



Never use a round nozzle to power wash tires. The intense jet of water can result in damage to the tire.

Always replace a damaged tire.

Operation

Tires and wheels

Direction of rotation

Unidirectional tires offer added advantages, such as better hydroplaning performance. To benefit, however, you must make sure the tires rotate in the direction specified.

An arrow on the sidewall indicates the intended direction of rotation (spinning) of the tire.



Spare wheels may be mounted against the direction of rotation (spinning) even with a unidirectional tire for temporary use only until the regular drive wheel has been repaired or replaced. Always observe and follow applicable temporary use restrictions and speed limitations indicated on the spare wheel.

Loading the vehicle

Two labels on your vehicle show how much weight it may properly carry.

- The Tire and Loading Information placard (Example A) or the Vehicle Tire Information placard (Example B) can be found on the driver's door B-pillar. This placard tells you important information about the number of people that can be in the vehicle and the total weight that can be carried in the vehicle. It also contains information on the proper size and recommended tire inflation pressures for the original equipment tires on your vehicle.
- The Certification label, also found on the driver's door B-pillar, tells you about the gross weight capacity of your vehicle, called the Gross Vehicle Weight Rating (GVWR). The GVWR includes the weight of the vehicle, all occupants, fuel and cargo. The Certification label also tells you about the front and rear axle weight capacity, called the Gross Axle Weight Rating (GAWR). The GAWR is the total allowable weight that can be carried by a single axle (front or rear). Never exceed the GVWR or GAWR for either the front axle or rear axle.



① Driver's door B-pillar

Following is a discussion on how to work with the information contained on the two placards with regards to loading your vehicle.

Tire and Loading Information

Warning!



Do not overload the tires by exceeding the specified load limit as indicated on the placard on the driver's door B-pillar. Overloading the tires can overheat them, possibly causing a blowout. Overloading the tires can also result in handling or steering problems, or brake failure.

Your vehicle is equipped with either the Tire and Loading Information placard (Example A) or the Vehicle Tire Information placard (Example B).

Operation

Tires and wheels



Data shown on placard examples are for illustration purposes only. Load limit data are specific to each vehicle and may vary from data shown in the illustrations below. Refer to placard on vehicle for actual data specific to your vehicle.

Placard (Example A)



① Load limit information on the Tire and Loading Information placard

Operation

Tires and wheels

The placard showing the load limit information is located on the driver's door B-pillar. If your vehicle is equipped with the Tire and Loading Information placard (Example A), locate the statement "The combined weight of occupants and cargo should never exceed XXX kilograms or XXX lbs." on this placard. The combined weight of all occupants, cargo/luggage and trailer tongue load (if applicable) should never exceed the weight referenced in that statement.

Placard (Example B)



① Load limit information on the Vehicle Tire Information placard

The placard showing the load limit information is located on the driver's door B-pillar. If your vehicle is equipped with the Vehicle Tire Information placard (Example B), locate the heading "Vehicle Capacity Weight" on this placard. The combined weight of all occupants, cargo/luggage and trailer tongue (if applicable) should never exceed the weight listed next to vehicle capacity weight.

Seating capacity

The seating capacity gives you important information on the number of occupants that can be in the vehicle. Observe front and rear seating capacity. Depending on production date, your vehicle may be equipped with placard Example A or placard Example B.

Your vehicle may not be equipped with placard A nor other placard posting the seating capacity. If this is the case, legal requirements at time of production of your vehicle did not require manufacturers to post the seating capacity.

Never let more people ride in the vehicle than there are designated seating positions and seat belts available. Be sure everyone riding in the vehicle is correctly restrained with a separate seat belt.



Data shown on placard examples are for illustration purposes only. Seating data are specific to each vehicle and may vary from data shown in the illustrations below. Refer to placard on vehicle for actual data specific to your vehicle.

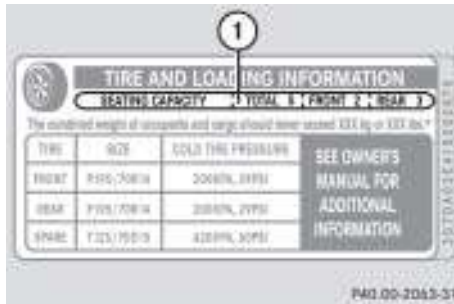

Placard (Example A)

① Seating capacity



Placard (Example B)

① Seating capacity

Steps for determining correct load limit

The following steps have been developed as required of all manufacturers under Title 49, Code of U.S. Federal Regulations, Part 575 pursuant to the “National Traffic and Motor Vehicle Safety Act of 1966”.

Step 1 (Vehicles equipped with placard Example A)

- ▶ Locate the statement “The combined weight of occupants and cargo should never exceed XXX kg or XXX lbs.” on your vehicle’s placard.

Step 1 (Vehicles equipped with placard Example B)

- ▶ Locate the heading “Vehicle Capacity Weight” on your vehicle’s placard.

Step 2

- ▶ Determine the combined weight of the driver and passengers that will be riding in your vehicle.

Step 3

- ▶ Subtract the combined weight of the driver and passengers from XXX kilograms or XXX lbs.

Step 4

- ▶ The resulting figure equals the available amount of cargo and luggage load capacity. For example, if the “XXX” amount equals 1400 lbs and there will be five 150 lbs passengers in your vehicle, the amount of available cargo and luggage load capacity is 650 lbs (1400-750 (5 x150) = 650 lbs).

Step 5

- ▶ Determine the combined weight of luggage and cargo being loaded on the vehicle. That weight may not safely exceed the available cargo and luggage load capacity calculated in step 4. >>

Operation

Tires and wheels

▷▷ Step 6 (if applicable)

- ▶ If your vehicle will be towing a trailer, load from your trailer will be transferred to your vehicle. Consult this manual to determine how this reduces the available cargo and luggage load capacity of your vehicle (▷ page 344).

The following table shows examples on how to calculate total and cargo load capacities with varying seating configurations and number and size of occupants. The following examples use a load limit of 1500 lbs. **This is for illustration purposes only.** Make sure you are using the actual load limit for your vehicle stated on the vehicle's placard (▷ page 339).

Operation
Tires and wheels

Example	Combined weight limit of occupants and cargo from placard	Number of occupants (driver and passengers)	Seating configuration	Occupants weight	Combined weight of all occupants	Available cargo/luggage and trailer tongue weight (total load limit or vehicle capacity weight from placard minus combined weight of all occupants)
1	1500 lbs	5	front: 2 rear: 3	Occupant 1: 150 lbs Occupant 2: 180 lbs Occupant 3: 160 lbs Occupant 4: 140 lbs Occupant 5: 120 lbs	750 lbs	1500 lbs - 750 lbs = 750 lbs
2	1500 lbs	3	front: 1 rear: 2	Occupant 1: 200 lbs Occupant 2: 190 lbs Occupant 3: 150 lbs	540 lbs	1500 lbs - 540 lbs = 960 lbs
3	1500 lbs	1	front: 1	Occupant 1: 150 lbs	150 lbs	1500 lbs - 150 lbs = 1350 lbs

The higher the weight of all occupants, the less cargo and luggage load capacity is available.

For more information, see “Trailer tongue load” (> page 344).

Operation

Tires and wheels

Certification label

Even after careful determination of the combined weight of all occupants, cargo and the trailer tongue load (if applicable) (▷ page 344) as to not exceed the permissible load limit, you must make sure that your vehicle never exceeds the Gross Vehicle Weight Rating (GVWR) and the Gross Axle Weight Rating (GAWR) for either the front or rear axle. You can obtain the GVWR and GAWR from the Certification label. The Certification Label can be found on the driver's door B-pillar, see "Technical data" (▷ page 481).

Gross Vehicle Weight Rating (GVWR): The total weight of the vehicle, all occupants, all cargo, and the trailer tongue load (▷ page 344) must never exceed the GVWR.

Gross Axle Weight Rating (GAWR): The total allowable weight that can be carried by a single axle (front or rear).

To assure that your vehicle does not exceed the maximum permissible weight limits (GVWR and GAWR for front and rear axle), have the loaded vehicle (including driver, passengers and all cargo and, if applicable, trailer fully loaded) weighed on a suitable commercial scale.

Trailer tongue load

The tongue load of any trailer is an important weight to measure because it affects the load you can carry in your vehicle. If a trailer is towed, the tongue load must be added to the weight of all occupants riding and any cargo you are carrying in the vehicle. The tongue load typically is between 10% and 15% of the trailer weight and everything loaded in it.

For more information on trailer tongue load, see "Loading a trailer" (▷ page 315).

Recommended tire inflation pressure

Warning!



Follow recommended tire inflation pressures.

Do not underinflate tires. Underinflated tires wear excessively and/or unevenly, adversely affect handling and fuel economy, and are more likely to fail from being overheated.

Do not overinflate tires. Overinflated tires can adversely affect handling and ride comfort, wear unevenly, increase stopping distance, and result in sudden deflation (blowout) because they are more likely to become punctured or damaged by road debris, potholes etc.

Your vehicle is equipped with the Certification label (Example B) which also lists the recommended tire and rim sizes as well as cold tire inflation pressures.

Depending on production date, some vehicles may also be equipped with a Tire and Loading Information placard (Example A).

The tire inflation pressure should be checked regularly and should only be adjusted on cold tires. The tires can be considered cold if the vehicle has been parked for at least three hours or driven less than one mile (1.6 km).

Follow recommended cold tire inflation pressures listed on placard.

Keeping the tires properly inflated provides the best handling, tread life and riding comfort.

In addition to the tire placard on the driver's door B-pillar, also consult the fuel filler flap for any additional information pertaining to special driving situations. For more information, see "Important notes on tire inflation pressure" (> page 346).

Operation

Tires and wheels



Data shown on placard examples are for illustration purposes only. Tire data are specific to each vehicle and may vary from data shown in the illustrations below. Refer to placard on vehicle for actual data specific to your vehicle.

Placard (Example A)

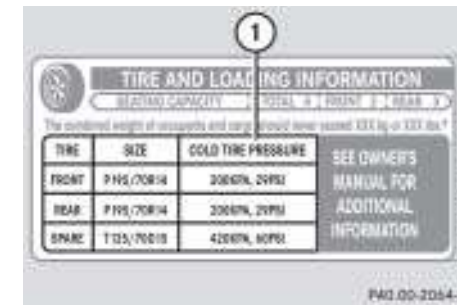

- ① Tire and Loading Information placard with recommended cold tire inflation pressures

Operation

Tires and wheels

Placard (Example A) lists the recommended cold tire inflation pressures for maximum loaded vehicle weight. The tire inflation pressures listed apply to the tires installed as original equipment.

Placard (Example B)



① Certification label with recommended tire inflation pressures

Placard (Example B) lists the recommended cold tire inflation pressures for maximum loaded vehicle weight. The tire inflation pressures listed apply to the tires installed as original equipment.

Important notes on tire inflation pressure

Warning!



If the tire inflation pressure repeatedly drops:

- Check the tires for punctures from foreign objects.
- Check to see whether air is leaking from the valves or from around the rim.

Tire temperature and tire inflation pressure are also increased while driving, depending on the driving speed and the tire load.

If you will be driving your vehicle at high speeds of 100 mph (160 km/h) or higher, where it is legal and conditions allow, consult the placard on the inside of the fuel filler flap on how to adjust the cold tire inflation pressure. If you do not adjust the tire inflation pressure, excessive heat can build up and result in sudden tire failure.

Be sure to readjust the tire inflation pressure for normal driving speeds. You should wait until the tires are cold before adjusting the tire inflation pressure.

Some vehicles may have supplemental tire inflation pressure information for vehicle loads less than the maximum loaded vehicle condition. If such information is provided, it can be found on the placard located on the inside of the fuel filler flap.

Tire inflation pressure changes by approximately 1.5 psi (0.1 bar) per 18°F (10°C) of air temperature change. Keep this in mind when checking tire inflation pressure where the temperature is different from the outside temperature.

Checking tire inflation pressure

Regularly check your tire inflation pressure at least once a month.

Check and adjust the tire inflation pressure when the tires are cold. The tires can be considered cold if the vehicle has been parked for at least three hours or driven less than one mile (1.6 km).

If you check the tire inflation pressure when the tires are warm (the vehicle has been driven for several miles or sitting less than three hours), the reading will be approximately 4 psi (0.3 bar) higher than the cold reading. This is normal. Do not let air out to match the specified cold tire inflation pressure. Otherwise, the tire will be underinflated.

Warning!



Follow recommended tire inflation pressures.

Do not underinflate tires. Underinflated tires wear excessively and/or unevenly, adversely affect handling and fuel economy, and are more likely to fail from being overheated.

Do not overinflate tires. Overinflated tires can adversely affect handling and ride comfort, wear unevenly, increase stopping distance, and result in sudden deflation (blowout) because they are more likely to become punctured or damaged by road debris, potholes etc.

Do not overload the tires by exceeding the specified load limit as indicated on the placard on the driver's door B-pillar. Overloading the tires can overheat them, possibly causing a blowout.

Checking tire inflation pressure manually

Follow the steps below to achieve correct tire inflation pressure:

- ▶ Remove the cap from the valve on one tire.
- ▶ Firmly press a tire gauge onto the valve.
- ▶ Read tire inflation pressure on tire gauge and check against the recommended tire inflation pressure on the placard on the driver's door B-pillar (> page 339) or, if available, the inside of the fuel filler flap. If necessary, add air to achieve the recommended tire inflation pressure. >>

Operation

Tires and wheels



If you have overfilled the tire, release tire inflation pressure by pushing the metal stem of the valve with e.g. a tip of a pen. Then recheck the tire inflation pressure with the tire gauge.

- ▶ Install the valve cap.
- ▶ Repeat this procedure for each tire.

Run Flat Indicator

While the vehicle is being driven, the Run Flat Indicator monitors the set tire inflation pressures by evaluating each wheel's rotational speed. This allows the system to detect a significant loss of pressure in a tire. If a wheel's rotational speed changes due to falling tire inflation pressure, you will see a corresponding warning message in the multifunction display.

The Run Flat Indicator may function in a restricted manner or with a delay if:

- snow chains are mounted to the vehicle
- winter road conditions prevail
- you are driving on a loose surface (e.g. sand or gravel)
- you are driving in a very sporty manner (involving rapid acceleration or high speeds in curves)

Warning!



When the multifunction display shows the message **Tire pressure Check tires**, one or more of your tires is significantly under-inflated. You should stop and check your tires as soon as possible, and inflate them to the proper tire inflation pressure as indicated on the vehicle's tire information placard. Driving on a significantly under-inflated tire causes the tire to overheat and can lead to tire failure. Under-inflation also reduces fuel efficiency and tire tread life, and may affect the vehicle's handling and stopping ability. Each tire, including the spare, should be checked monthly when cold and set to the recommended tire inflation pressure as specified in the vehicle placard and owner's manual.

Operation

Tires and wheels



The recommended tire inflation pressures for your vehicle can be found on the tire placard located on the driver's door B-pillar (▷ page 339). The tire inflation pressures are not listed in the owner's manual.

Warning!



The Run Flat Indicator does not indicate a warning for wrongly selected tire inflation pressures. Always adjust tire inflation pressure according to the placard on the driver's door B-pillar or fuel filler flap.

The Run Flat Indicator does not replace regular checks of the tire inflation pressures since a gradual pressure loss in all four tires cannot be detected by the Run Flat Indicator.

The Run Flat Indicator is not able to issue a warning due to a sudden dramatic loss of tire inflation pressure (e.g. tire blowout caused by a foreign object). In this case bring the vehicle to a halt by carefully applying the brakes and avoiding abrupt steering maneuvers.

Warning!



Follow recommend tire inflation pressures.

Do not underinflate tires. Underinflated tires wear excessively and/or unevenly, adversely affect handling and fuel economy, and are more likely to fail from being overheated.

Do not overinflate tires. Overinflated tires can adversely affect handling and ride comfort, wear unevenly, increase stopping distance, and result in sudden deflation (blowout) because they are more likely to become punctured or damaged by road debris, potholes etc.

Do not overload the tires by exceeding the specified load limit or vehicle capacity weight as indicated on the placard on the driver's door B-pillar. Overloading the tires can overheat them, possibly causing a blowout.

Operation

Tires and wheels

Reactivating the Run Flat Indicator

The tire inflation pressure monitor must be reactivated in the following situations:



- If you have changed the tire inflation pressure
- If you have replaced the wheels or tires
- If you have installed new wheels or tires
- ▶ Using the tire placard on the driver's door B-pillar or, if available, the inside of the fuel filler flap, make sure the tire inflation pressure of all four tires is correct.

Warning!



The Run Flat Indicator can only warn you in a reliable manner if you have set the correct tire inflation pressures for each tire.

If an incorrect tire inflation pressure was set, the system will monitor the pressure according to the incorrect value.

- ▶ Switch on the ignition (▷ page 34).
Make sure the standard display menu appears in the multifunction display (▷ page 150).
- ▶ Press button  or  repeatedly until the following message appears in the multifunction display:



- ▶ Press button .

The following message will appear in the multifunction display:
Tire pressure OK now?

If you wish to confirm activation:

- ▶ Press button .

The following message will appear in the multifunction display:
Run Flat Indicator
reactivated

After a certain “learning phase”, the Run Flat Indicator checks the set pressure values for all four tires.

If you wish to cancel activation:

- ▶ Press button .

or

- ▶ Wait until the message
Tire pressure OK now?
disappears.

Checking tire pressure electronically with the Advanced Tire Pressure Monitoring System* (Advanced TPMS*)



The Advanced Tire Pressure Monitoring System* (Advanced TPMS*) is equipped with a combination low tire pressure/TPMS malfunction telltale in the instrument cluster (▷ page 24). Depending on how the telltale illuminates, it indicates a low tire pressure condition or a malfunction in the TPMS system itself:



- If the telltale illuminates continuously, one or more of your tires is significantly under-inflated. There is no malfunction in the TPMS.
- If the telltale flashes for 60 seconds and then stays illuminated, the TPMS system itself is not operating properly.

The TPMS only functions on wheels that are equipped with the proper electronic sensors. It monitors the tire inflation pressure, as selected by the driver, in all four tires. A warning is issued to alert you to a decrease in pressure in one or more of the tires.

Tire pressure inquiries are made using the multifunction display. The present inflation pressures are displayed only after a few minutes' travel time.



Possible differences between the readings of a tire pressure gauge of an air hose, e.g. gas station equipment, and the vehicle's control system can occur. Usually the readings issued by the control system are more precise.

- ▶ Switch on the ignition (▷ page 34).
- ▶ Press the  or  button until the current inflation pressures for each tire appear in the multifunction display.

Operation

Tires and wheels



When the message Tire pressure display appears after driving several minutes appears in the display, the individual inflation pressure values are matched with the tires. The individual values are displayed after a few minutes driving.



With a spare wheel without wheel sensor mounted, the system may still indicate the tire inflation pressure of the removed wheel for some minutes. If this happens, keep in mind that the indicated value where the spare wheel is mounted does not reflect the actual spare tire inflation pressure.

Operation

Tires and wheels

Warning!



The TPMS does not indicate a warning for wrongly selected inflation pressures. Always adjust tire inflation pressure according to the placard on the driver's door B-pillar or, if available, the supplemental tire pressure information on the inside of the fuel filler flap.

The TPMS is not able to issue a warning due to a sudden dramatic loss of pressure (e.g. tire blowout caused by a foreign object). In this case bring the vehicle to a halt by carefully applying the brakes and avoiding abrupt steering maneuvers.

Warning!



Each tire, including the spare (if provided), should be checked monthly when cold and inflated to the inflation pressure recommended by the vehicle manufacturer on the vehicle placard or the tire inflation pressure label. (If your vehicle has tires of a different size than the size indicated on the vehicle placard or the tire inflation pressure label, you should consult the appropriate section of this owner's manual to determine the proper tire inflation pressure). When the low tire pressure telltale is illuminated, one or more of your tires is significantly under-inflated. You should stop and check your tires as soon as possible, and inflate them to the proper pressure. Driving on a significantly under-inflated tire causes the tire to overheat and can lead to tire failure. Under-inflation also reduces fuel efficiency and tire tread life, and may affect the vehicle's handling and stopping ability.

Your vehicle has also been equipped with a TPMS malfunction telltale to indicate when the system is not operating properly. When the malfunction telltale is illuminated, the system may not be able to detect or signal low tire pressure as intended. TPMS malfunctions may occur for a variety of reasons, including the installation of incompatible replacement tires on the vehicle. Always check the TPMS malfunction telltale after replacing one or more tires on your vehicle to ensure that the replacement tires are compatible with the TPMS.

Operation

Tires and wheels



If a condition causing the TPMS to malfunction develops, it may take up to 10 minutes for the system to signal a malfunction using the TPMS telltale flashing and illumination sequence.

The telltale extinguishes after a few minutes driving if the malfunction has been corrected.



Operating radio transmission equipment (e.g. wireless headsets, two-way radios) in or near the vehicle could cause the TPMS to malfunction.



Reactivating Advanced TPMS*

The TPMS must be reactivated when you have adjusted the tire inflation pressure to a new level (e.g. because of different load or driving conditions). The TPMS is then recalibrated to the current tire inflation pressures.

- ▶ Using the tire placard on the driver's door B-pillar (▷ page 339) or, if available, the supplemental tire pressure information on the inside of the fuel filler flap (▷ page 346), make sure the tire inflation pressure of all four tires is correct.







Reactivate the TPMS after adjusting the tire inflation pressure to the inflation pressure recommended for the vehicle operating condition. Tire pressure should only be adjusted on cold tires. Observe the recommended tire inflation pressure on the placard on the driver's door B-pillar (▷ page 339). Some vehicles may have supplemental tire pressure information for driving at high speeds (▷ page 346) or for vehicle loads less than the maximum loaded vehicle condition (▷ page 346). If such information is provided, it can be found on the inside of the fuel filler flap.

- ▶ Press button  or  on the multifunction steering wheel repeatedly until the standard display menu appears in the multifunction display (▷ page 156).

▷▷

Operation

Tires and wheels

- ▷▷ Press the  or  button repeatedly until you see the current inflation pressures for each tire appear in the display or the following message appears in the display
Tire pressure display appears after driving several minutes
- ▶ Press the reset button (▷ page 24).
The following message will appear in the multifunction display:
Check current tire pressure?
- ▶ Press the  button.
The following message will appear in the multifunction display:
Tire pressure monitor reactivated
The TPMS will now monitor the tire inflation pressure values of all four tires.
- If you wish to cancel activation:
- ▶ Press the  button.

Potential problems associated with underinflated and overinflated tires

Underinflated tire inflation pressure

Underinflated tires can:

- cause excessive and uneven tire wear
- adversely affect fuel economy
- lead to tire failure from being overheated
- adversely affect handling characteristics

Warning!



Follow recommended tire inflation pressures.

Do not underinflate tires. Underinflated tires wear excessively and/or unevenly, adversely affect handling and fuel economy, and are more likely to fail from being overheated.

Overinflated tire inflation pressure

Overinflated tires can:

- adversely affect handling characteristics
- cause uneven tire wear
- be more prone to damage from road hazards
- adversely affect ride comfort
- increase stopping distance

Warning!



Follow recommended tire inflation pressures.

Do not overinflate tires. Overinflated tires can adversely affect handling and ride comfort, wear unevenly, increase stopping distance, and result in sudden deflation (blowout) because they are more likely to become punctured or damaged by road debris, potholes etc.

Tire labeling

Besides tire name (sales designation) and manufacturer name, a number of markings can be found on a tire.

Following are some explanations for the markings on your vehicle's tires:

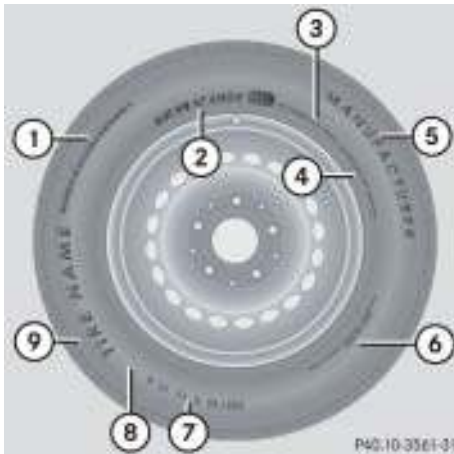

- ① Uniform Quality Grading Standards (▷ page 362)
- ② DOT, Tire Identification Number (TIN) (▷ page 360)
- ③ Maximum tire load (▷ page 361)
- ④ Maximum tire inflation pressure (▷ page 362)
- ⑤ Manufacturer
- ⑥ Tire ply material (▷ page 364)
- ⑦ Tire size designation, load and speed rating (▷ page 355)
- ⑧ Load identification (▷ page 359)
- ⑨ Tire name



For illustration purposes only. Actual data on tires are specific to each vehicle and may vary from data shown in above illustration.

For more information, see "Rims and tires" (▷ page 487).

Tire size designation, load and speed rating

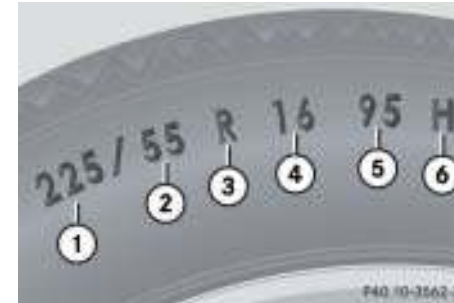

- ① Tire width
- ② Aspect ratio in %
- ③ Radial tire code
- ④ Rim diameter
- ⑤ Tire load rating
- ⑥ Tire speed rating



For illustration purposes only. Actual data on tires are specific to each vehicle and may vary from data shown in above illustration.

Operation

Tires and wheels

General:

Depending on the design standards used, the tire size molded into the sidewall may have no letter or a letter preceding the tire size designation.

No letter preceding the size designation (as illustrated above): Passenger car tire based on European design standards.

Letter “P” preceding the size designation: Passenger car tire based on U.S. design standards.

Letter “LT” preceding the size designation: Light Truck tire based on U.S. design standards.

Letter “T” preceding the size designation: Temporary spare tires which are high pressure compact spares designed for temporary emergency use only.

Tire width

The tire width ① (▷ page 355) indicates the nominal tire width in mm.

Aspect ratio

The aspect ratio ② (▷ page 355) is the dimensional relationship between tire section height and section width and is expressed in percentage. The aspect ratio is arrived at by dividing section height by section width.

Tire code

The tire code ③ (▷ page 355) indicates the tire construction type. The “R” stands for radial tire type. Letter “D” means diagonal or bias ply construction; letter “B” means belted-bias ply construction.

At the tire manufacturer’s option, any tire with a speed capability above 149 mph (240 km/h) can include a “ZR” in the size designation (for example: 245/40 ZR 18). For additional information, see “Tire speed rating” (▷ page 357).

Rim diameter

The rim diameter ④ (▷ page 355) is the diameter of the bead seat, not the diameter of the rim edge. Rim diameter is indicated in inches (in).

Tire load rating

The tire load rating ⑤ (▷ page 355) is a numerical code associated with the maximum load a tire can support.

For example, a load rating of 91 corresponds to a maximum load of 1356 lbs (615 kg) the tire is designed to support. See also “Maximum tire load” (▷ page 361) where the maximum load associated with the load index is indicated in kilograms and lbs.

Operation

Tires and wheels

Warning!



The tire load rating must always be at least half of the GAWR (▷ page 365) of your vehicle. Otherwise, tire failure may be the result which may cause an accident and/or serious personal injury to you or others.

Always replace rims and tires with the same designation, manufacturer and type as shown on the original part.

Warning!



Do not overload the tires by exceeding the specified load limit as indicated on the placard located on the driver's door B-pillar. Overloading the tires can overheat them, possibly causing a blowout. Overloading the tires can also result in handling or steering problems, or brake failure.

For additional information on tire load rating, see “Load identification” (▷ page 359).



Tire load rating ⑤ (▷ page 355) and Tire speed rating ⑥ (▷ page 355) are also referred to as “service description”.

Tire speed rating

The tire speed rating ⑥ (▷ page 355) indicates the approved maximum speed for the tire.

Warning!



Even when permitted by law, never operate a vehicle at speeds greater than the maximum speed rating of the tires.

Exceeding the maximum speed for which tires are rated can lead to sudden tire failure, causing loss of vehicle control and possibly resulting in an accident and/or personal injury and possible death, for you and for others.



Tire load rating ⑤ (▷ page 355) and Tire speed rating ⑥ (▷ page 355) are also referred to as “service description”.

Operation

Tires and wheels

Summer tires

Index	Speed rating
Q	up to 100 mph (160 km/h)
R	up to 106 mph (170 km/h)
S	up to 112 mph (180 km/h)
T	up to 118 mph (190 km/h)
H	up to 130 mph (210 km/h)
V	up to 149 mph (240 km/h)
W	up to 168 mph (270 km/h)
Y	up to 186 mph (300 km/h)
(Y)	above 186 mph (300 km/h)
ZR	above 149 mph (240 km/h)

- At the tire manufacturer's option, any tire with a speed capability above 149 mph (240 km/h) can include a "ZR" in the size designation (for example: 245/40 ZR18). To determine the maximum speed capability of the tire, the service description for the tire must be referred to. The service description

is comprised of the tire load rating ⑤ (▷ page 355) and the tire speed rating ⑥ (▷ page 355).

If your tire includes "ZR" in the size designation and no service description ⑤ and ⑥ (▷ page 355) is given, the tire manufacturer must be consulted for the maximum speed capability.

If a service description ⑤ and ⑥ (▷ page 355) is given, the speed capability is limited by the speed symbol in the service description.

Example: 245/40 ZR18 97Y.

In this example, "97Y" is the service description. The letter "Y" designates the speed rating and the speed capability of the tire is limited to 186 mph (300 km/h).

- Any tire with a speed capability above 186 mph (300 km/h) must include a "ZR" in the size designation AND the service description must be placed in parenthesis. Example: 275/40 ZR 18 (99Y). The "(Y)" speed rating in parenthesis designates the maximum speed capability of the tire as being above 186 mph (300 km/h). Consult the tire manufacturer for the actual maximum permissible speed of the tire.

All-season and winter tires

Index	Speed rating
Q M+S ¹	up to 100 mph (160 km/h)
T M+S ¹	up to 118 mph (190 km/h)
H M+S ¹	up to 130 mph (210 km/h)
V M+S ¹	up to 149 mph (240 km/h)

¹ or M+S  for winter tires



Not all M+S rated tires provide special winter performance. Make sure the tires you use show M+S and the mountain/snowflake  marking on the tire sidewall. These tires meet specific snow traction performance requirements of the Rubber Manufacturers Association (RMA) and the Rubber Association of Canada (RAC) and have been designed specifically for use in snow conditions.

Load identification



① Load identification



For illustration purposes only. Actual data on tires are specific to each vehicle and may vary from data shown in above illustration.

In addition to tire load rating, special load information may be molded into the tire sidewall following the letter designating the tire speed rating ① (▷ page 355).

No specification given: absence of any text (like in above example) indicates a standard load (SL) tire.

XL or Extra Load: designates an extra load (or reinforced) tire.

Light Load: designates a light load tire.

C, D, E: designates load range associated with the maximum load a tire can carry at a specified pressure.

Operation

Tires and wheels

DOT, Tire Identification Number (TIN)

U.S. tire regulations require each new tire manufacturer or tire retreader to mold a TIN into or onto a sidewall of each tire produced.

The TIN is a unique identifier which facilitates efforts by tire manufacturers to notify purchasers in recall situations or other safety matters concerning tires and gives purchasers the means to easily identify such tires.

The TIN is comprised of “Manufacturer’s identification mark”, “Tire size”, “Tire type code” and “Date of manufacture”.



- ① DOT
- ② Manufacturer’s identification mark
- ③ Tire size
- ④ Tire type code (at the option of the tire manufacturer)
- ⑤ Date of manufacture



For illustration purposes only. Actual data on tires are specific to each vehicle and may vary from data shown in above illustration.

DOT (Department of Transportation)

A tire branding symbol ① (▷ page 360) which denotes the tire meets requirements of the U.S. Department of Transportation.

Manufacturer’s identification mark

The manufacturer’s identification mark ② (▷ page 360) denotes the tire manufacturer.

New tires have a mark with two symbols.

Retreaded tires have a mark with four symbols. For more information on retreaded tires, see (▷ page 335).

Tire size

The code ③ (▷ page 360) indicates the tire size.

Tire type code

The code ④ (▷ page 360) may, at the option of the manufacturer, be used as a descriptive code for identifying significant characteristics of the tire.

Date of manufacture

The date of manufacture ⑤ (▷ page 360) identifies the week and year of manufacture.

The first two figures identify the week, starting with “01” to represent the first full week of the calendar year. The second two figures represent the year.

For example, “3202” represents the 32nd week of 2002.

Maximum tire load



① Maximum tire load rating



For illustration purposes only. Actual data on tires are specific to each vehicle and may vary from data shown in above illustration.

The maximum tire load is the maximum weight the tires are designed to support.

Operation

Tires and wheels

Warning!



Do not overload the tires by exceeding the specified load limit as indicated on the placard located on the driver's door B-pillar. Overloading the tires can overheat them, possibly causing a blowout. Overloading the tires can also result in handling or steering problems, or brake failure.

For more information on tire load rating (▷ page 356).

For information on calculating total and cargo load capacities (▷ page 341).

Operation

Tires and wheels

Maximum tire inflation pressure



① Maximum permissible tire inflation pressure



For illustration purposes only. Actual data on tires are specific to each vehicle and may vary from data shown in above illustration.

This is the maximum permissible tire inflation pressure for the tire.

Always follow the recommended tire inflation pressure (▷ page 345) for proper tire inflation.

Warning!



Never exceed the max. tire inflation pressure. Follow recommended tire inflation pressures.

Do not underinflate tires. Underinflated tires wear excessively and/or unevenly, adversely affect handling and fuel economy, and are more likely to fail from being overheated.

Do not overinflate tires. Overinflated tires can adversely affect handling and ride comfort, wear unevenly, increase stopping distance, and result in sudden deflation (blowout) because they are more likely to become punctured or damaged by road debris, potholes etc.

Uniform Tire Quality Grading Standards (U.S. vehicles)

Tire manufacturers are required to grade tires based on three performance factors: treadwear, traction and temperature resistance.



- ① Treadwear
- ② Traction
- ③ Temperature resistance



For illustration purposes only. Actual data on tires are specific to each vehicle and may vary from data shown in above illustration.

Quality grades can be found, where applicable, on the tire sidewall between tread shoulder and maximum section width. For example:

Treadwear	Traction	Temperature
200	AA	A

All passenger car tires must conform to federal safety requirements in addition to these grades.

Treadwear

The treadwear grade is a comparative rating based on the wear rate of the tire when tested under controlled conditions on a specified government test course. For example, a tire graded 150 would wear one and one-half ($1\frac{1}{2}$) times as well on the government course as a tire graded 100. The relative performance of tires depends upon the actual conditions of their use, however, and may depart significantly from the norm due to variations in driving habits, service practices and differences in road characteristics and climate.

Operation

Tires and wheels

Traction

The traction grades, from highest to lowest, are AA, A, B, and C. Those grades represent the tire's ability to stop on wet pavement as measured under controlled conditions on specified government test surfaces of asphalt and concrete. A tire marked C may have poor traction performance.

Warning!



The traction grade assigned to this tire is based on straight-ahead braking traction tests, and does not include acceleration, cornering, hydroplaning, or peak traction characteristics.

Operation

Tires and wheels

Temperature

The temperature grades are A (the highest), B, and C, representing the tire's resistance to the generation of heat and its ability to dissipate heat when tested under controlled conditions on a specified indoor laboratory test wheel. Sustained high temperature can cause the material of the tire to degenerate and reduce tire life, and excessive temperature can lead to sudden tire failure. The grade C corresponds to a level of performance which all passenger car tires must meet under the Federal Motor Vehicle Safety Standard No. 109. Grades B and A represent higher levels of performance on the laboratory test wheel than the minimum required by law.

Warning!



The temperature grade for this tire is established for a tire that is properly inflated and not overloaded. Excessive speed, underinflation, or excessive loading, either separately or in combination, can cause excessive heat build-up and possible tire failure.

Tire ply material



- ① Plies in sidewall
- ② Plies under tread



For illustration purposes only. Actual data on tires are specific to each vehicle and may vary from data shown in above illustration.

This marking tells you about the type of cord and number of plies in the sidewall and under the tread.

Tire and loading terminology

Accessory weight

The combined weight (in excess of those standard items which may be replaced) of automatic transmission, power steering, power brakes, power windows, power seats, radio, and heater, to the extent that these items are available as factory-installed equipment (whether installed or not).

Air pressure

The amount of air inside the tire pressing outward on each square inch of the tire. Air pressure is expressed in pounds per square inch (psi), or kilopascal (kPa) or bars.

Aspect ratio

Dimensional relationship between tire section height and section width expressed in percentage.

Bar

Another metric unit for air pressure. There are 14.5038 pounds per square inch (psi) to 1 bar; there are 100 kilopascals (kPa) to 1 bar.

Bead

The tire bead contains steel wires wrapped by steel cords that hold the tire onto the rim.

Cold tire inflation pressure

Tire inflation pressure when your vehicle has been sitting for at least three hours or driven no more than one mile (1.6 km).

Curb weight

The weight of a motor vehicle with standard equipment including the maximum capacity of fuel, oil, and coolant, and, if so equipped, air conditioning and additional optional equipment, but without passengers and cargo.

DOT (Department of Transportation)

A tire branding symbol which denotes the tire meets requirements of the U.S. Department of Transportation.

GAWR (Gross Axle Weight Rating)

The GAWR is the maximum permissible axle weight. The gross vehicle weight on each axle must never exceed the GAWR for the front and rear axle indicated on the certification label located on the driver's door B-pillar.

GTW (Gross Trailer Weight)

The GTW is the weight of the trailer plus the weight of all cargo, equipment, luggage etc. loaded on the trailer.

Operation

Tires and wheels

GVW (Gross Vehicle Weight)

The GVW comprises the weight of the vehicle including fuel, tools, spare wheel, installed accessories, passengers and cargo and, if applicable, trailer tongue load. The GVW must never exceed the GVWR indicated on the certification label located on the driver's door B-pillar.

GVWR (Gross Vehicle Weight Rating)

This is the maximum permissible vehicle weight of the fully loaded vehicle (weight of the vehicle including all options, passengers, fuel, and cargo and, if applicable, trailer tongue load). It is indicated on certification label located on the driver's door B-pillar.

Kilopascal (kPa)

The metric unit for air pressure. There are 6.9 kPa to 1 psi; another metric unit for air pressure is bars. There are 100 kilopascals (kPa) to 1 bar.

Maximum load rating

The maximum load in kilograms and pounds that can be carried by the tire.

Maximum loaded vehicle weight

The sum of curb weight, accessory weight, vehicle capacity weight and production options weight.

Maximum tire inflation pressure

This number is the greatest amount of air pressure that should ever be put in the tire under normal driving conditions.

Normal occupant weight

The number of occupants the vehicle is designed to seat, multiplied by 68 kilograms (150 lbs).

Occupant distribution

The distribution of occupants in a vehicle at their designated seating positions.

Production options weight

The combined weight of those installed regular production options weighing over 5 lbs (2.3 kilograms) in excess of those standard items which they replace, not previously considered in curb weight or accessory weight, including heavy duty brakes, ride levelers, roof rack, heavy duty battery, and special trim.

PSI (Pounds per square inch)

A standard unit of measure for air pressure -> bar, kilopascal (kPa).

Recommended tire inflation pressure

Recommended tire inflation pressure listed on placard located on driver's door B-pillar for normal driving conditions. Provides best handling, tread life and riding comfort.

Rim

A metal support for a tire or a tire and tube assembly upon which the tire beads are seated.

Sidewall

The portion of a tire between the tread and the bead.

TIN (Tire Identification Number)

Unique identifier which facilitates efforts by tire manufacturers to notify purchasers in recall situations or other safety matters concerning tires and gives purchases the means to easily identify such tires. The TIN is comprised of “Manufacturer’s identification mark”, “Tire size”, “Tire type code” and “Date of manufacture”.

Tire load rating

Numerical code associated with the maximum load a tire can support.

Tire ply composition and material used

This indicates the number of plies or the number of layers of rubber-coated fabric in the tire tread and sidewall. Tire manufacturers also must indicate the ply materials in the tire and sidewall, which include steel, nylon, polyester, and others.

Tire speed rating

Part of tire designation; indicates the speed range for which a tire is approved.

Traction

Force exerted by the vehicle on the road via the tires. The amount of grip provided.

Tread

The portion of a tire that comes into contact with the road.

Treadwear indicators

Narrow bands, sometimes called “wear bars” that show across the tread of a tire when only $\frac{1}{16}$ in (1.6 mm) of tread remains.

TWR (Tongue Weight Rating)

Maximum permissible weight on trailer tongue.

Uniform Tire Quality Grading Standards

A tire information system that provides consumers with ratings for a tire’s traction, temperature and treadwear. Ratings are determined by tire manufacturers using government testing procedures. The ratings are molded into the sidewall of the tire.

Vehicle capacity weight

Rated cargo and luggage load plus 68 kilograms (150 lbs) times the vehicle’s designated seating capacity.

Operation

Tires and wheels

Vehicle maximum load on the tire

Load on an individual tire that is determined by distributing to each axle its share of the maximum loaded vehicle weight and dividing it by two.

Rotating tires

Warning!



Rotate front and rear wheels only if they are of the same dimension.

If your vehicle is equipped with mixed-size tires (different tire dimensions front vs. rear), tire rotation is not possible.

Tire rotation can be performed on vehicles with tires of the same dimension all around. If your vehicle is equipped with tires of the same dimension all around, tires can be rotated, observing a front-to-rear rotation pattern that will maintain the intended rotation (spinning) direction of the tire (▷ page 338).

In some cases, such as when your vehicle is equipped with mixed-size tires (different tire dimension front vs. rear), tire rotation is not possible.

If applicable to your vehicle's tire configuration, tires can be rotated according to the tire manufacturer's recommended intervals in the tire manufacturer's warranty pamphlet located in your vehicle literature portfolio. If none is available, tires should be rotated every 3000 to 6000 miles (5000 to 10000 km), or sooner if necessary, according to the degree of tire wear. The same rotation (spinning) direction must be maintained (▷ page 338).

Rotate tires before the characteristic tire wear pattern becomes visible (shoulder wear on front tires and tread center wear on rear tires).

Thoroughly clean the mounting face of wheels and brake disks, i.e. the inner side of the wheels/tires, during each rotation. Check for and ensure proper tire inflation pressure.

Warning!



Have the tightening torque checked after changing a wheel. Wheels could become loose if not tightened with a torque of 110 lb-ft (150 Nm).

Only use genuine Mercedes-Benz wheel bolts specified for your vehicle's rims.

For information on wheel change, see the "Practical hints" section (▷ page 430) and (▷ page 456).

▼ Winter driving

Before the onset of winter, have your vehicle winterized at an authorized Mercedes-Benz Light Truck Center. This service includes:

- Check of anticorrosion and antifreeze concentration.
- Addition of cleaning concentrate to the water of the windshield and headlamp cleaning system. Add MB Concentrate "S" to a premixed windshield washer solvent/antifreeze which is formulated for below freezing temperatures (▷ page 500).
- Battery test. Battery capacity drops with decreasing ambient temperature. A well charged battery helps to make sure that the engine can be started even at low ambient temperatures.
- Tire change. Mercedes-Benz recommends M+S rated radial-ply tires with a minimum tread depth of approximately $\frac{1}{6}$ in (4 mm) on all four wheels for the winter season.

Winter tires

Always use winter tires at temperatures below 45°F (7°C) and whenever wintry road conditions prevail. Not all M+S rated tires provide special winter performance. Make sure the tires you use show the mountain/snowflake  marking on the tire sidewall. These tires meet specific snow traction performance requirements of the Rubber Manufacturers Association (RMA) and The Rubber Association of Canada (RAC) and have been designed specifically for use in snow conditions. Use of winter tires is the only way to achieve the maximum effectiveness of the ABS, ESP[®] and SBC in winter operation.

For safe handling, make sure all mounted winter tires are of the same make and have the same tread design.

Operation

Winter driving

Warning!



Winter tires with a tread depth under $\frac{1}{6}$ in (4 mm) must be replaced. They are no longer suitable for winter operation.

Always observe the speed rating of the winter tires installed on your vehicle. If the maximum speed for which your tires are rated is below the speed rating of your vehicle, you must place a notice to this effect where it will be seen by the driver. Such notices are available from your tire dealer or from any authorized Mercedes-Benz Light Truck Center.

Operation

Winter driving

Warning!



If you use your spare tire when winter tires are fitted on the other wheels, be aware that the difference in tire characteristics may very well impair turning stability and that overall driving stability may be reduced. Adapt your driving style accordingly.

Have the spare tire replaced with a winter tire at the nearest authorized Mercedes-Benz Light Truck Center.

Block heater (Canada only)

The engine is equipped with a block heater.

The electrical cable may be installed at an authorized Mercedes-Benz Light Truck Center.

Snow chains

Snow chains should only be driven on snow-covered roads at speeds not to exceed 30 mph (50 km/h). Remove chains as soon as possible when driving on roads without snow.



When driving with snow chains, you may wish to deactivate the ESP[®] (▷ page 97) before setting the vehicle in motion. This will improve the vehicle's traction.

Please observe the following guidelines when using snow chains:

- Use of snow chains is not permissible with all wheel/tire combinations.
- Snow chains should only be used on the rear wheels. Follow the manufacturer's mounting instructions.
- Only use snow chains that are approved by Mercedes-Benz. Your authorized Mercedes-Benz Light Truck Center will be glad to advise you on this subject.
- Use of snow chains may be prohibited depending on location. Always check local and state laws before installing snow chains.



Even on vehicles with all-wheel-drive use snow chains on rear tires only.

The use of snow chains is not permissible with the spare wheel.

▼ Maintenance

We strongly recommend that you have your vehicle serviced by an authorized Mercedes-Benz Light Truck Center, in accordance with the Maintenance Booklet at the times called for by the maintenance service indicator display.

Failure to have the vehicle maintained in accordance with the Maintenance Booklet and maintenance service indicator at the designated times/mileage will result in vehicle damage not covered by the Mercedes-Benz Limited Warranty.

The maintenance service indicator will notify you when your next maintenance service is due.

Starting approximately one month before maintenance service is due, one of the following messages will appear in the multifunction display while you are driving or when you switch on the ignition (example service A):

Service A in XXXXX miles (km)

Service A in XXX days

Service A in X day

The maintenance services will be indicated by showing a service type A through type H in the multifunction display. Types A through H are classified based on estimated time needed to perform the maintenance service, ranging:

from Service A
(approx. one hour)

to Service H
(approx. eight hours)

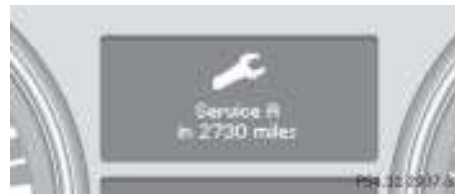

Vehicles equipped with FSS PLUS (Flexible Service System PLUS) only (Canada vehicles): The interval between maintenance services depends on your driving habits. A gentle driving style, moderate engine speeds and the avoidance of short-distance trips will lengthen the interval between services.

Operation

Maintenance

Clearing the maintenance service indicator

The maintenance service indicator is automatically cleared after ten seconds when you switch on the ignition or when reaching the service threshold while driving. You can also clear it yourself.

- ▶ Press reset button on the instrument cluster (▷ page 24).

Maintenance service term exceeded



If you have exceeded the suggested maintenance service term, you will see the following message in the multifunction display:

Service A exceeded by XXXXX miles (km)
Service A exceeded by XXX days
Service A exceeded by X day

In addition, a signal sounds when the message appears.

Any authorized Mercedes-Benz Light Truck Center will reset the maintenance service indicator following a completed maintenance service.

Calling up the service indicator

- ▶ Switch on the ignition (▷ page 34).
The standard display of the control system appears (▷ page 156).
- ▶ Press button  or  on the multifunction steering wheel until the maintenance service indicator with the service symbol  and the service deadline appears in the multifunction display.



If the battery is disconnected, the days of disconnection will not be included in the count shown by the maintenance service indicator. To arrive at the true maintenance service deadline, you will need to subtract these days from the days shown in the maintenance service indicator.

Do not confuse the maintenance service indicator with the engine oil level indicator .

Resetting the maintenance service indicator

In the event that the maintenance service on your vehicle is not carried out by an authorized Mercedes-Benz Light Truck Center, you can have the maintenance service indicator reset. The automotive maintenance facility carrying out the maintenance service will find the information for resetting the maintenance service indicator in the maintenance-relevant information for your vehicle. Such information is available from either your authorized Mercedes-Benz Light Truck Center or directly from Mercedes-Benz.



If the maintenance service indicator was inadvertently reset, have an authorized Mercedes-Benz Light Truck Center correct it.

Only reset if the proper maintenance service has been performed. Resetting the system without performing the proper service as called for by the maintenance service indicator will result in engine damage and/or other vehicle damage not covered by the Mercedes-Benz Limited Warranty.

Operation

Vehicle care

Cleaning and care of the vehicle

Warning!



Many cleaning products can be hazardous. Some are poisonous, others are flammable. Always follow the instructions on the particular container. Always open your vehicle's doors or windows when cleaning the inside. Never use fluids or solvents that are not designed for cleaning your vehicle.

While in operation, even while parked, your vehicle is subjected to varying external influences which, if gone unchecked, can attack the paintwork as well as the underbody and cause lasting damage.

Such damage is caused not only by extreme and varying climatic conditions, but also by:

- Air pollution
- Road salt
- Tar
- Gravel and stone chipping

To avoid paint damage, you should immediately remove:

- Grease and oil
- Fuel
- Coolant
- Brake fluid
- Bird droppings
- Insects
- Tree resins, etc.

Frequent washing reduces and/or eliminates the aggressiveness and potency of the above adverse influences.

More frequent washings are necessary to deal with unfavorable conditions:

- near the ocean
- in industrial areas (smoke, exhaust emissions)
- during winter operation

You should check your vehicle from time to time for stone chipping or other damage. Any damage should be repaired as soon as possible to prevent corrosion.

In doing so, do not neglect the underbody of the vehicle. A prerequisite for a thorough check is a washing of the underbody followed by a thorough inspection. Damaged areas need to be re-undercoated.

Your vehicle has been treated at the factory with a wax-base rustproofing in the body cavities which will last for the lifetime of the vehicle. Post-production treatment is neither necessary nor recommended by Mercedes-Benz because of the possibility of incompatibility between materials used in the production process and others applied later.

We have selected car-care products and compiled recommendations which are specially matched to our vehicles and which always reflect the latest technology. You can obtain Mercedes-Benz approved car-care products at an authorized Mercedes-Benz Light Truck Center.

Scratches, corrosive deposits, corrosion or damage due to negligent or incorrect care cannot always be removed or repaired with the car-care products recommended here. In such cases it is best to seek aid at an authorized Mercedes-Benz Light Truck Center.

The following topics deal with the cleaning and care of your vehicle and give important “how-to” information as well as references to Mercedes-Benz approved car-care products.

Power washer

When using a power washer for cleaning the vehicle, always observe manufacturer’s operating instructions.



Vehicles with KEYLESS-GO*:
If a door handle is hit by a strong jet of water, and a SmartKey with KEYLESS-GO* is in close proximity, i.e. within approximately 3 ft (approximately 1 m), the vehicle could be inadvertently locked or unlocked.



Never use a round nozzle to power-wash tires. The intense jet of water can result in damage to the tire.

Always replace a damaged tire.

Always keep the jet of water moving across the surface. Do not aim directly at electrical parts, electrical connectors, seals, or other rubber parts.

Tar stains

Quickly remove tar stains before they dry and become more difficult to remove. A tar remover is recommended.

Paintwork, painted body components

Mercedes-Benz approved Paint Care should be applied when water drops on the paint surface do not “bead up”, normally every three to five months, depending on climate and washing detergent used.

Mercedes-Benz approved Paint Cleaner should be applied if the paint surface shows signs of dirt embedding (i.e. loss of gloss).

Do not apply any of these products or wax if your vehicle is parked in the sun or if the hood is still hot.

Use the appropriate MB-Touch-Up Stick for quick and provisional repairs of minor paint damage (i.e. chips from stones, vehicle doors, etc.).

Operation

Vehicle care

Engine cleaning

Prior to cleaning the engine compartment make sure to protect electrical components and connectors from the intrusion of water and cleaning agents.

Corrosion protection, such as MB Anticorrosion Wax, should be applied to the engine compartment after every engine cleaning. Before applying, all control linkage bushings and joints should be lubricated. The poly-V-belt and all pulleys should be protected from any wax.

Vehicle washing

Do not use hot water or wash your vehicle in direct sunlight. Only use a mild car wash detergent, such as Mercedes-Benz approved Car Shampoo.

Thoroughly spray the vehicle with a diffused jet of water. Direct only a very weak spray towards the ventilation intake. Use plenty of water and rinse the sponge and chamois frequently.

Rinse with clear water and thoroughly dry with a chamois. Do not allow cleaning agents to dry on the finish.



Due to the width of the vehicle, fold in exterior rear view mirrors prior to running the vehicle through an automatic car wash to prevent damage to the mirrors.



After running the vehicle through an automatic car wash, wipe any wax off of the windshield (▷ page 378) and the wiper blade inserts (▷ page 378). This will prevent smears and reduce wiping noise which can be caused by residual wax on the windshield.

In the winter, thoroughly remove all traces of road salt as soon as possible.

When washing the underbody, do not forget to clean the inner sides of the wheels.



Vehicles with KEYLESS-GO*:
If a door handle is hit by a strong jet of water, and a SmartKey with KEYLESS-GO* is in close proximity, i.e. within approximately 3 ft (approximately 1 m), the vehicle could be inadvertently locked or unlocked.

Ornamental moldings

For regular cleaning and care of very dirty chrome-plated parts, use a chrome cleaner.

Headlamps, tail lamps, side markers, turn signal lenses

Use a mild car wash detergent, such as Mercedes-Benz approved Car Shampoo, with plenty of water.

To prevent scratches, never apply strong force and only use a soft, non-scratchy cloth when cleaning the lenses. Do not attempt to wipe dirty lenses with a dry cloth or sponge.

Cleaning the Parktronic* system sensors

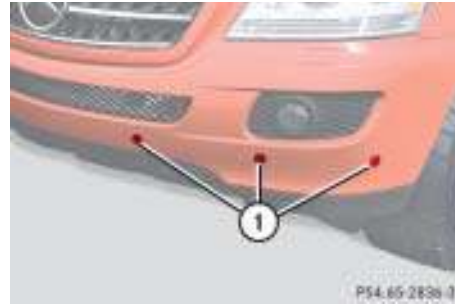

- ① Parktronic* system sensors
- Clean the sensors ① on the bumpers using a mild car wash detergent, such as Mercedes-Benz approved Car Shampoo, with plenty of water and a soft, non-scratchy cloth.

When using a steam cleaner or power washer, aim nozzle only briefly from a minimum distance of 12 in (30 cm) at sensors ①.

Do not apply strong pressure to the sensor cover, applying strong pressure may damage the sensor cover.

To prevent scratches, never apply strong force and only use a soft, non-scratchy cloth when cleaning the sensor. Do not attempt to wipe dirty sensors with a dry cloth or sponge.

Operation

Vehicle care

Wiper blades

- ▶ Fold wiper arms forward until they snap into place.

Warning!



For safety reasons, switch off wipers and remove SmartKey from starter switch (vehicles with KEYLESS-GO*: Make sure the vehicle's on-board electronics have status **0**) before cleaning the wiper blades. Otherwise, the wiper motor could suddenly turn on and cause injury.

- ▶ Clean the wiper blade inserts with a clean cloth and detergent solution.



Fold the windshield wiper arms back onto the windshield before turning the SmartKey in the starter switch.

Hold on to the wiper when folding the wiper arm back. If released, the force of the impact from the tensioning spring could crack the windshield.

Window cleaning

- ▶ Fold wiper arms forward until they snap into place.

Warning!



For safety reasons, switch off wipers and remove SmartKey from starter switch (vehicles with KEYLESS-GO*: Make sure the vehicle's on-board electronics have status **0**) before cleaning the windshield. Otherwise, the wiper motor could suddenly turn on and cause injury.

- ▶ Use a window cleaning solution on all glass surfaces.

An automotive glass cleaner is recommended.



Fold the windshield wiper arms back onto the windshield before turning the SmartKey in the starter switch.

Hold on to the wiper when folding the wiper arm back. If released, the force of the impact from the tensioning spring could crack the windshield.

Light alloy wheels

Mercedes-Benz approved Wheel Care should be used for regular cleaning of the light alloy wheels.

If possible, clean wheels once a week with Mercedes-Benz approved Wheel Care, using a soft bristle brush and a strong spray of water.

Follow instructions on container.



Only use acid-free cleaning materials. Acid may cause corrosion or damage the clear coat.

Instrument cluster

Use a gentle dishwashing detergent or mild detergent for delicate fabrics as a washing solution. Wipe with a cloth moistened in lukewarm solution. Do not use scouring agents.

Steering wheel and gear selector lever

Wipe with a damp cloth and dry thoroughly or clean with Mercedes-Benz approved Leather Care.

Carpet

Carpet and Fabric Care approved by Mercedes-Benz should be used for cleaning of carpets in your vehicle.

Cup holder

Use a gentle dishwashing detergent or mild detergent for delicate fabrics as a washing solution. Wipe with a cloth moistened in lukewarm solution. Do not use scouring agents.

Hard plastic trim items

Pour Mercedes-Benz approved Interior Care onto soft lint-free cloth and apply with light pressure.

Headliner and rear window shelf

Clean with soft bristle brush, or use a dry-shampoo cleaner in case of excessive dirt.

Seat belts

The webbing must not be treated with chemical cleaning agents. Only use clear, lukewarm water and soap. Do not dry the webbing at temperatures above 176°F (80°C) or in direct sunlight.

Warning!



Do not bleach or dye seat belts as this may severely weaken them. In a crash they may not be able to provide adequate protection.

Operation

Vehicle care

Upholstery

Using aftermarket seat covers or wearing clothing that has the tendency to give off coloring (e.g. when wet, etc.) may cause the upholstery to become permanently discolored. By lining the seats with a proper intermediate cover, contact-discoloration will be prevented.

*Leather upholstery**

Wipe leather upholstery with a damp cloth and dry thoroughly or clean with Mercedes-Benz approved Leather Care. Exercise particular care when cleaning perforated leather as its underside should not become wet.

MB Tex upholstery

Pour Mercedes-Benz approved Interior Care onto soft lint-free cloth and apply with light pressure.

Plastic and rubber parts

Do not use oil or wax on these parts.

Wood trims

Dampen cloth using water and use damp cloth to clean wood trims in your vehicle. Do not use solvents like tar remover or wheel cleaner nor polishes or waxes as these may be abrasive.

Practical hints

What to do if ...

Where will I find ...?

Unlocking/locking in an emergency

Opening/closing in an emergency

Replacing SmartKey batteries

Replacing bulbs

Replacing wiper blades

Flat tire

Battery

Jump starting

Towing the vehicle

Fuses



Practical hints

What to do if ...

Lamps in instrument cluster

General information:
If any of the following lamps in the instrument cluster fails to come on during the

bulb self-check when switching on the ignition, have the respective bulb checked and replaced if necessary.

Problem	Possible cause	Suggested solution
 The yellow ABS indicator lamp comes on while the engine is running.	<p>ABS has detected a malfunction and has switched off. The BAS, ESP[®], and 4-ETS are also switched off (see messages in multifunction display).</p> <p>The brake system is still functioning normally but without the ABS available.</p> <p>If the ABS control unit is malfunctioning, other systems such as the navigation system* or the automatic transmission may also be malfunctioning.</p>	<ul style="list-style-type: none"> ▶ Continue driving with added caution. Wheels may lock during hard braking, reducing steering capability. ▶ Read and observe messages in the multifunction display (▷ page 395). ▶ Have the system checked at an authorized Mercedes-Benz Light Truck Center as soon as possible. <p>Failure to follow these instructions increases the risk of an accident.</p>
	<p>The charging voltage has fallen below ten volts. The ABS has switched off.</p> <p>The battery might not be charged sufficiently.</p>	<ul style="list-style-type: none"> ▶ Switch off electrical consumers that are currently not needed, e.g. seat heating*. ▶ If necessary, have the generator (alternator) and the battery checked. <p>When the voltage is above this value again, the ABS is operational again.</p>

Practical hints
What to do if ...

Problem	Possible cause	Suggested solution
BRAKE  (USA only) (Canada only)	The red brake warning lamp comes on while driving and you hear a warning sound.	▶ Release the parking brake.
	The ESP [®] control unit may be malfunctioning. The driving safety systems may not be available.	▶ Continue driving with added caution. Wheels may lock during hard braking, reducing steering capability. ▶ Read and observe messages in the display.

Warning! 





Driving with the brake warning lamp illuminated can result in an accident. Have your brake system checked immediately if the brake warning lamp stays on. Do not add brake fluid before checking the brake system. Overfilling the brake fluid reservoir can result in spilling brake fluid on hot engine parts and the brake fluid catching fire. You can be seriously burned.

!

If you find that the brake fluid in the brake fluid reservoir has fallen to the minimum mark or below, have the brake system checked for brake pad thickness and leaks.



Practical hints

What to do if ...

Problem		Possible cause	Suggested solution
BRAKE   	(USA only) (Canada only)	The red brake warning lamp comes on while driving. In addition, the yellow ABS malfunction indicator lamp, and the yellow ESP [®] warning lamp come on and a warning will sound.	A malfunction in the EBP was detected. ► Have the system checked at an authorized Mercedes-Benz Light Truck Center as soon as possible. Failure to follow these instructions increases the risk of an accident.
BRAKE 	(USA only) (Canada only)	The red brake warning lamp comes on while driving.	There is insufficient brake fluid in the reservoir. ► Risk of accident! Carefully stop the vehicle and notify an authorized Mercedes-Benz Light Truck Center. Do not add brake fluid! This will not solve the problem.



Practical hints

What to do if ...

Problem	Possible cause	Suggested solution
 (USA only)  (Canada only) The yellow engine malfunction indicator lamp comes on while driving.	There is a malfunction in: <ul style="list-style-type: none"> • The fuel management system • The ignition system • The emission control system • Systems which affect emissions Such malfunctions may result in excessive emissions values and may switch the engine to its limp-home (emergency operation) mode (▷ page 192).	► Have the vehicle checked as soon as possible by an authorized Mercedes-Benz Light Truck Center. An on-board diagnostic connector is used by the service station to link the vehicle to the shop diagnostics system. It allows the accurate identification of system malfunctions through the readout of diagnostic trouble codes. It is located in the front left area of the footwell next to the parking brake pedal.



Practical hints

What to do if ...

Problem	Possible cause	Suggested solution
 (USA only)  (Canada only) The yellow engine malfunction indicator lamp comes on while driving.	A loss of pressure has been detected in the fuel system. The fuel cap may not be closed properly or the fuel system may be leaky.	<ul style="list-style-type: none"> ▶ Check the fuel cap (▷ page 323). If it is not closed properly: <ul style="list-style-type: none"> ▶ Close the fuel cap. If it is closed properly: <ul style="list-style-type: none"> ▶ Have the fuel system checked by an authorized Mercedes-Benz Light Truck Center.
	Your fuel tank is empty.	<ul style="list-style-type: none"> ▶ After refueling start, turn off and restart the engine three or four times in succession. The limp-home mode is canceled. You do not need to have your vehicle checked.

Practical hints

What to do if ...



Problem	Possible cause	Suggested solution
 The yellow ESP [®] warning lamp comes on while the engine is running.	The ESP [®] is deactivated. Risk of accident! Adapt your speed and driving to the prevailing road, weather, and traffic conditions.	<ul style="list-style-type: none"> ▶ Switch the ESP[®] back on (▷ page 98). If the ESP [®] cannot be switched back on, have the system checked at an authorized Mercedes-Benz Light Truck Center as soon as possible.
 The yellow ESP [®] warning lamp flashes while driving.	The ESP [®] or traction control has come into operation because of detected traction loss of at least one tire.	<ul style="list-style-type: none"> ▶ When driving off, apply as little throttle as possible. ▶ While driving, ease up on the accelerator. ▶ Adapt your speed and driving to the prevailing road and weather conditions. ▶ Do not deactivate the ESP[®]. Exceptions: (▷ page 97). Failure to follow these instructions increases the risk of an accident.

Practical hints

What to do if ...

Problem	Possible cause	Suggested solution
The yellow fuel tank reserve warning lamp comes on while driving.	The fuel level has gone below the reserve mark.	▶ Refuel at the next gas station (▷ page 323).
 The red seat belt telltale comes on and a warning chime sounds for approximately six seconds after starting the engine with all doors closed.	The seat belt telltale reminds you and your passengers to fasten your seat belts before driving off.	▶ Fasten your seat belts. The seat belt telltale goes out.

Practical hints
What to do if ...

Problem	Possible cause	Suggested solution
 The red seat belt telltale remains illuminated after driving off. The vehicle's speed does not exceed 15 mph (25 km/h).	<p>You and/or your front passenger have forgotten to fasten your seat belts.</p> <p>There are items placed on the front passenger seat and therefore the system senses the front passenger seat as being occupied.</p>	<ul style="list-style-type: none"> ▶ Fasten your seat belts. ▶ Remove the items from the front passenger seat and put them in a safe place.
 The red seat belt telltale flashes and you additionally hear an intermittent warning chime with increasing intensity for a maximum of 60 seconds from the time the vehicle's speed exceeds 15 mph (25 km/h).	<p>You and/or your front passenger have forgotten to fasten your seat belts.</p> <p>There are items placed on the front passenger seat and therefore the system senses the front passenger seat as being occupied.</p>	<ul style="list-style-type: none"> ▶ Fasten your seat belts. ▶ Remove the items from the front passenger seat and put them in a safe place.

 After 60 seconds with an unfastened seat belt on one of the front seats the warning chime stops sounding and the seat belt telltale illuminates continuously.

The seat belt telltale will only go out if both the driver and front passenger's seat belt are fastened, or the vehicle is standing still and a front door is opened.

Practical hints

What to do if ...

Problem	Possible cause	Suggested solution
<p>SRS The red SRS indicator lamp comes on while driving.</p>	<p>There is a malfunction in the restraint systems. The air bags or emergency tensioning device (ETDs) could deploy unexpectedly or fail to deploy unexpectedly in an accident.</p>	<p>► Drive with added caution to the nearest authorized Mercedes-Benz Light Truck Center.</p>



Warning!



In the event a malfunction of the SRS is indicated as outlined above, the SRS may not be operational. For your safety, we strongly recommend that you visit an authorized Mercedes-Benz Light Truck Center immediately to have the system checked, otherwise the SRS may not be activated when needed in an accident, which could result in serious or fatal injury, or it might deploy unexpectedly and unnecessarily which could result in an accident/or injury to you or to others.

Practical hints

What to do if ...

Problem	Possible cause	Suggested solution
 <p>Combination low tire pressure/TPMS malfunction telltale for the TPMS* illuminates continuously.</p>	<p>The Advanced TPMS* detects a loss of pressure in at least one tire.</p>	<ul style="list-style-type: none"> ▶ Carefully bring the vehicle to a halt, avoiding abrupt steering and braking maneuvers. Observe the traffic situation around you. ▶ Take note of the messages in the multi-function display. <p>If the tire inflation pressure in the respective tire(s) has (have) been corrected, the combination low tire pressure/TPMS malfunction telltale goes out after few minutes driving.</p>
 <p>Combination low tire pressure/TPMS malfunction telltale for the Advanced TPMS* flashes 60 seconds and then stays illuminated.</p>	<p>There is a malfunction in the Advanced TPMS*.</p>	<ul style="list-style-type: none"> ▶ Take note of the messages in the multi-function display. ▶ Have the Advanced TPMS* checked by an authorized Mercedes-Benz Light Truck Center. <p>After the malfunction has been remedied the combination low tire pressure/TPMS malfunction telltale goes out after few minutes driving.</p>

Practical hints

What to do if ...

Warning!





Each tire, including the spare (if provided), should be checked monthly when cold and inflated to the inflation pressure recommended by the vehicle manufacturer on the vehicle placard or the tire inflation pressure label. (If your vehicle has tires of a different size than the size indicated on the vehicle placard or the tire inflation pressure label, you should consult the appropriate section of this owner's manual to determine the proper tire inflation pressure). When the low tire pressure telltale is illuminated, one or more of your tires is significantly under-inflated. You should stop and check your tires as soon as possible, and inflate them to the proper pressure. Driving on a significantly under-inflated tire causes the tire to overheat and can lead to tire failure. Under-inflation also reduces fuel efficiency and tire tread life, and may affect the vehicle's handling and stopping ability.

Your vehicle has also been equipped with a TPMS malfunction telltale to indicate when the system is not operating properly. When the malfunction telltale is illuminated, the system may not be able to detect or signal low tire pressure as intended. TPMS malfunctions may occur for a variety of reasons, including the installation of incompatible replacement tires on the vehicle. Always check the TPMS malfunction telltale after replacing one or more tires on your vehicle to ensure that the replacement tires are compatible with the TPMS.



Practical hints

What to do if ...

Lamp in center console



Problem	Possible cause	Suggested solution
  The front passenger front air bag off indicator lamp illuminates and remains illuminated with the weight of a typical adult or someone larger than a small individual on the front passenger seat.	The system is malfunctioning.	<ul style="list-style-type: none"> ▶ Have the system checked as soon as possible by an authorized Mercedes-Benz Light Truck Center. ▶ Also note any messages in the multifunction display and follow corrective steps (> page 401).

Warning! 

If the   indicator lamp illuminates and remains illuminated with the weight of a typical adult or someone larger than a small individual on the front passenger seat, do not have any passenger use the front passenger seat until the system has been repaired.



Practical hints

What to do if ...

Problem	Possible cause	Suggested solution
  <p>The front passenger front air bag off indicator lamp does not illuminate and/or does not remain illuminated with the weight of a typical 12-month-old child in a standard child restraint or less on the front passenger seat.</p>	<p>The system is malfunctioning.</p>	<ul style="list-style-type: none"> ▶ Make sure there is nothing between seat cushion and child seat and check installation of the child seat. ▶ Make sure no objects applying supplemental weight onto the seat are present. ▶ Make sure no objects which apply forces to the seat are present (e.g. objects such as books, briefcases etc. lodged behind or around the seat, head restraints pushing against roof etc.). The system may recognize such forces as supplemental weight. ▶ If the front passenger front air bag off indicator lamp remains out, have the system checked as soon as possible by an authorized Mercedes-Benz Light Truck Center. Do not transport a child on the front passenger seat until the system has been repaired. ▶ Also note any messages in the multifunction display and follow corrective steps (▷ page 401).

Warning!



If the   indicator lamp does not illuminate or remains out with the weight of

a typical 12-month-old child in a standard child restraint or less on the front passenger seat, do not transport a child on the front

passenger seat until the system has been repaired.

Vehicle status messages in the multifunction display





Warning and malfunction messages appear in the multifunction display located in the instrument cluster.





Certain warning and malfunction messages are accompanied by an audible signal.

Address these messages accordingly and follow the additional instructions given in this Operator's Manual.

Selecting the vehicle status message memory menu in the control system (▷ page 159) displays both cleared and uncleared messages.

High-priority messages appear in the multifunction display in red color.

Certain messages of high priority cannot be cleared from the multifunction display using the reset button (▷ page 24) or button , , , or  on the multifunction steering wheel.

Other messages of high priority and messages of less immediate priority can be cleared from the multifunction display using the reset button (▷ page 24) or button , , , or  on the multifunction steering wheel. They are then stored in the vehicle status message memory (▷ page 159). Remember that clearing a message will only make the message disappear. Clearing a message will not correct the condition that caused the message to appear.

Practical hints

What to do if ...

Warning!



All categories of messages contain important information which should be taken note of and, where a malfunction is indicated, addressed as soon as possible at an authorized Mercedes-Benz Light Truck Center.

Failure to repair condition noted may cause damage not covered by the Mercedes-Benz Limited Warranty, or result in property damage or personal injury.

Warning!



No messages will be displayed if either the instrument cluster or the multifunction display is inoperative.

Contact the nearest authorized Mercedes-Benz Light Truck Center.

Practical hints

What to do if ...



Switching on the ignition causes all instrument cluster lamps (except low beam headlamp indicator lamp, high beam headlamp indicator lamp, and turn signal indicator lamps unless activated) as well as the multifunction display to come on. Make sure the lamps and multifunction display are in working order before starting your journey.

On the pages that follow, you will find a compilation of the most important warning and malfunction messages that may appear in the multifunction display.

For your convenience the messages are divided into two sections:

- Text messages (▷ page 397)
- Symbol messages (▷ page 407)

Practical hints
What to do if ...

Text messages

Display message	Possible cause	Possible solution
ABS Malfunction Visit workshop	<p>The ABS has detected a malfunction and has switched off. The ESP[®] and the BAS are also deactivated.</p> <p>The brake system is still functioning normally but without the ABS available.</p>	<ul style="list-style-type: none"> ▶ Continue driving with added caution. Wheels may lock during hard braking, reducing steering capability. ▶ Have the system checked at an authorized Mercedes-Benz Light Truck Center as soon as possible. <p>Failure to follow these instructions increases the risk of accident.</p>
Display malfunction Visit workshop	<p>The ABS or the ABS display is malfunctioning.</p>	<ul style="list-style-type: none"> ▶ Continue driving with added caution. Wheels may lock during hard braking, reducing steering capability ▶ Have the system checked at an authorized Mercedes-Benz Light Truck Center as soon as possible. <p>Failure to follow these instructions increases the risk of accident.</p>





Practical hints

What to do if ...

Display message	Possible cause	Possible solution
<p>ABS</p> <p>unavailable See Operator's Manual</p>	<p>The ABS was deactivated because of insufficient power supply. The charging voltage has fallen below ten volts.</p> <p>The brake system is still functioning normally but without the ABS available.</p>	<ul style="list-style-type: none"> ▶ Switch off electrical consumers that are currently not needed, e.g. seat heating*. ▶ If necessary, have the generator (alternator) and the battery checked. <p>When the voltage is above this value again, the ABS is operational again and the message in the multifunction display should disappear.</p>
<p>Battery protection</p> <p>Convenience functs. Temporarily Unavailable</p>	<p>The battery has insufficient voltage and can no longer supply convenience functions such as the rear window defroster.</p>	<p>As soon as the on-board voltage is sufficient, the consumers will switch on again.</p>
<p>Please note:</p> <p>Convenience Functions Available again</p>	<p>On-board voltage is sufficient; the consumers will switch on again.</p>	
<p>Cruise control</p> <p>Drive to workshop</p>	<p>Cruise control is malfunctioning.</p>	<ul style="list-style-type: none"> ▶ Have cruise control checked by an authorized Mercedes-Benz Light Truck Center.
<p>DSR</p> <p>Malfunction</p>	<p>Downhill Speed Regulation is malfunctioning.</p>	<ul style="list-style-type: none"> ▶ Have the Downhill Speed Regulation checked by an authorized Mercedes-Benz Light Truck Center.

Practical hints

What to do if ...

Display message	Possible cause	Possible solution
ESP unavailable See Operator's Manual	In addition, the yellow ESP [®] warning lamp  comes on. The ESP [®] is deactivated because of a malfunction or interrupted power supply.	<ul style="list-style-type: none"> ▶ Continue driving with added caution. ▶ Visit an authorized Mercedes-Benz Light Truck Center as soon as possible. Failure to follow these instructions increases the risk of accident.
	If the yellow ESP [®] warning lamp  flashes while driving and this message appears, the electronic traction system has switched off to prevent overheating of the drive wheel brakes.	As soon as the brakes have cooled off, the electronic traction system switches on again. The message in the multifunction display disappears and the ESP [®] warning lamp  go out.
	The self-diagnosis has not yet been completed.	The display will clear after driving a short distance at a vehicle speed of above 12 mph (20 km/h).
Malfunction Visit workshop	In addition, the yellow ESP [®] warning lamp  comes on. The ESP [®] has detected a malfunction and switched off. The ABS may still be operational.	<ul style="list-style-type: none"> ▶ Continue driving with added caution. ▶ Have the system checked at an authorized Mercedes-Benz Light Truck Center as soon as possible. Failure to follow these instructions increases the risk of an accident.

Practical hints



What to do if ...

Display message	Possible cause	Possible solution
<p>ESP</p> <p>Display malfunction Visit workshop</p>	<p>In addition, the yellow ESP[®] warning lamp  comes on.</p> <p>The ESP[®] or the ESP[®] display is malfunctioning.</p>	<ul style="list-style-type: none"> ▶ Continue driving with added caution. ▶ Visit an authorized Mercedes-Benz Light Truck Center as soon as possible. <p>Failure to follow these instructions increases the risk of accident.</p>
<p>P</p> <p>Gear selector lever in park position</p>	<p>You have attempted to turn off the engine with the KEYLESS-GO* start/stop button with the gear selector lever not in P.</p> <p>You have opened the driver's door with the gear selector lever not in P.</p>	<ul style="list-style-type: none"> ▶ Select gear position P using the gear selector lever.
<p>Please move gear selector lever to N or P</p>	<p>You have attempted to start the engine with the KEYLESS-GO* start/stop button while the gear selector lever was in position R or D.</p>	<ul style="list-style-type: none"> ▶ Select gear position P or N using the gear selector lever. <p>Make sure the brake pedal is depressed when attempting to start the engine with the KEYLESS-GO* start/stop button.</p>

Display message	Possible cause	Possible solution
Front passenger airbag activated see Oper.'s Man.	Front passenger front air bag is activated while driving even though a child, small individual, or object below the system's weight threshold is on the front passenger seat, or the front passenger seat is empty. Objects on the seat or forces acting on the seat may make the system sense supplemental weight.	<p>Stop the vehicle in a safe location as soon as possible and check the front passenger seat for the following:</p> <ul style="list-style-type: none"> ▶ Switch off the ignition (▷ page 34). ▶ Remove child and child restraint from front passenger seat and properly secure the child in rear seat employing the child restraint if necessary. ▶ Remove any other items from on and around the front passenger seat and make sure the storage bag on the back of the front passenger seat is empty. ▶ Make sure that no objects which apply forces to the seat are present (e.g. objects such as books, briefcases etc. lodged behind or around the seat, head restraints pushing against roof etc.). The system may recognize such forces as supplemental weight and sense that an occupant on the front passenger seat is of a greater weight than actually present. ▶ Keep the seat unoccupied, close the front passenger door and switch on the ignition (▷ page 34). <p>(Continued on next page)</p>

Practical hints

What to do if ...

Display message	Possible cause	Possible solution
Front passenger airbag activated see Oper.'s Man.		<p>Monitor the  indicator lamp on the center console (▷ page 27) and the multifunction display in the instrument cluster (▷ page 24) for the following:</p> <p>With the seat unoccupied and the ignition turned on,</p> <ul style="list-style-type: none"> the  indicator lamp on the center console should illuminate and remain illuminated, indicating that the OCS (▷ page 81) has deactivated the air bag. the message Front passenger airbag activated see Oper.'s Man. or the message Front passenger airbag deactivated see Oper.'s Man. should not appear in the multifunction display at any time the seat is unoccupied. Wait at least 60 seconds for the system to complete the necessary check cycles and to make sure neither message appears in the multifunction display. <p>If above conditions are met, you can occupy the front passenger seat again. Depending on the front passenger classification sensed by the OCS (▷ page 81), the  indicator lamp will remain illuminated or go out.</p> <p>If above conditions are not met, the system is not working properly. Have the system checked as soon as possible by an authorized Mercedes-Benz Light Truck Center.</p>

Warning!



If the  indicator lamp remains



out even after performing the above corrective steps, do not have any children 12 years old and under and other small individuals

use the front passenger seat until the system has been repaired.

Display message	Possible cause	Possible solution
Front passenger airbag deactivated see Oper.'s Man.	Front passenger front air bag is deactivated while driving even though an adult or someone larger than a small individual is occupying the front passenger seat. Forces acting on the seat may make the system sense a decrease in weight.	<p>Stop the vehicle in a safe location as soon as possible and check the front passenger seat for the following:</p> <ul style="list-style-type: none"> ▶ Switch off the ignition (▷ page 34). ▶ Have the front passenger vacate the seat and exit the vehicle. ▶ Adjust the seat in a height position (▷ page 39). ▶ Make sure that no objects which apply forces to the seat are present (e.g. objects such as books, briefcases etc. lodged underneath, behind or around the seat). Such forces may cause the system to sense that an occupant of a lesser weight than actually present is on the front passenger seat. ▶ Keep the seat unoccupied, close the front passenger door and switch on the ignition (▷ page 34). <p>(Continued on next page)</p>

Practical hints

What to do if ...

Display message	Possible cause	Possible solution
Front passenger airbag deactivated see Oper.'s Man.		<p>Monitor the  indicator lamp on the center console (▷ page 27) and the multifunction display in the instrument cluster (▷ page 24) for the following:</p> <p>With the seat unoccupied and the ignition turned on,</p> <ul style="list-style-type: none"> the  indicator lamp on the center console should illuminate and remain illuminated, indicating that the OCS (▷ page 81) has deactivated the air bag. the message Front passenger airbag activated see Oper.'s Man. or the message Front passenger airbag deactivated see Oper.'s Man. should not appear in the multifunction display at any time the seat is unoccupied. Wait at least 60 seconds for the system to complete the necessary check cycles and to make sure neither message appears in the multifunction display. <p>If above conditions are met, you can occupy the front passenger seat again. Depending on the front passenger classification sensed by the OCS (▷ page 81), the  indicator lamp will remain illuminated or go out.</p> <p>If above conditions are not met, the system is not working properly. Have the system checked as soon as possible by an authorized Mercedes-Benz Light Truck Center.</p>

Warning!



If the  indicator lamp remains

illuminated with an adult occupant on the front passenger seat even after performing the above corrective steps, do not have any

passenger use the front passenger seat until the system has been repaired.

Practical hints

What to do if ...

Display message	Possible cause	Possible solution
Run Flat Indicator inactive	Run Flat Indicator is malfunctioning.	<ul style="list-style-type: none"> ▶ Have the Run Flat Indicator checked by an authorized Mercedes-Benz Light Truck Center.
Check tires Then reactivate Run Flat Indicator	There was a warning message about a loss in the tire inflation pressure and the Run Flat Indicator has not been reactivated yet.	<ul style="list-style-type: none"> ▶ Make sure that the correct tire inflation pressure is set for each tire. ▶ Then reactivate the Run Flat Indicator.
Run Flat Indicator unavailable	The Run Flat Indicator has been switched off due to an error.	<ul style="list-style-type: none"> ▶ Have the Run Flat Indicator checked by an authorized Mercedes-Benz Light Truck Center.
Tire pressure Check tires	The Run Flat Indicator indicates that the pressure is too low in one or more tires.	<ul style="list-style-type: none"> ▶ Carefully bring the vehicle to a halt, avoiding abrupt steering and braking maneuvers. Observe the traffic situation around you. ▶ Check and adjust tire inflation pressure as required (▷ page 348). ▶ If necessary, change the wheel (▷ page 457). ▶ Reactivate the Run Flat Indicator after adjusting the tire inflation pressure values (▷ page 350).

Practical hints

What to do if ...

Display message	Possible cause	Possible solution
Tire pressure display appears after driving several minutes	The tire inflation pressure is being checked.	▶ Drive the vehicle for a few minutes.
Tire pressure monitor inoperative	The Advanced TPMS* is malfunctioning.	▶ Have the Advanced TPMS* checked by an authorized Mercedes-Benz Light Truck Center.
Tire pres. monitor inoperative No wheel sensors	There are wheels without wheel sensors mounted (e.g. winter tires).	▶ Have the Advanced TPMS* checked by an authorized Mercedes-Benz Light Truck Center. ▶ Have the wheel sensors install by an authorized Mercedes-Benz Light Truck Center.
Tire pres. monitor Wheel sensor missing	One or more sensors defect (e.g. battery in one or more wheel sensor is empty). One or more wheels without wheel sensors mounted (e.g. spare tire).	▶ Have the Advanced TPMS* checked by an authorized Mercedes-Benz Light Truck Center. ▶ Have the wheel sensors install by an authorized Mercedes-Benz Light Truck Center. The tire pressure for the respective tire is not shown in the multifunction display.
Tire pres. monitor temporarily unavailable	The Advanced TPMS* is unable to monitor the tire pressure due to <ul style="list-style-type: none"> • a nearby radio interference source. • excessive wheel sensor temperatures. 	▶ As soon as the causes of the malfunction have been removed, the Advanced TPMS* automatically becomes active again after a few minutes driving.



Practical hints
What to do if ...

Symbol messages



Display symbol	Display messages	Possible cause	Possible solution
	Undervoltage Switch off consumers	The battery has insufficient voltage.	▶ Turn off unnecessary electrical consumers.
	malfunction Visit workshop	The battery was charged with a battery charger or jump started.	▶ Have the battery checked at a service station.
	Battery/Alternator Stop vehicle	The battery is no longer charging. Possible causes: <ul style="list-style-type: none"> • alternator malfunctioning • broken poly-V-belt Do not forget that the brake system requires electrical energy and may be operating with restricted capability. Considerably greater brake pedal force is required and the stopping distance is increased.	▶ Stop immediately and check the poly-V-belt. If it is broken: <ul style="list-style-type: none"> ▶ Do not continue to drive. Otherwise the engine will overheat due to an inoperative water pump which may result in damage to the engine. Notify an authorized Mercedes-Benz Light Truck Center. If it is intact: <ul style="list-style-type: none"> ▶ Drive immediately to the nearest authorized Mercedes-Benz Light Truck Center. Adjust driving to be consistent with reduced braking responsiveness.

Practical hints

What to do if ...

Display symbol	Display message	Possible cause	Possible solution
	Brake wear Visit workshop	The brake pads have reached their wear limit.	<ul style="list-style-type: none"> ▶ Brake pad thickness must be visually inspected at the intervals specified in the Maintenance Booklet. ▶ Have the brake pads replaced as soon as possible.
BRAKE (USA only)  (Canada only)	Changed braking behavior Drive with extreme care	A malfunction in the Electronic Brake Proportioning (▷ page 98) was detected.	<ul style="list-style-type: none"> ▶ Continue driving with added caution. Wheels may lock during hard braking, reducing steering capability. ▶ Read and observe messages in the display. ▶ Have the system checked at an authorized Mercedes-Benz Light Truck Center as soon as possible. <p>Failure to follow these instructions increases the risk of an accident.</p>

Practical hints
What to do if ...

Display symbol	Display message	Possible cause	Possible solution
 (USA only)	Release parking brake	You are driving with the parking brake set.	▶ Release the parking brake (▷ page 52).
 (Canada only)	Brake fluid too low Visit workshop	There is insufficient brake fluid in the reservoir.	▶ Risk of accident! Stop the vehicle and notify an authorized Mercedes-Benz Light Truck Center. Do not add brake fluid! This will not solve the problem.

Warning! 

Driving with the message Brake fluid too low Visit workshop displayed can result in an accident. Have your brake system checked immediately. Do not add brake fluid before checking the brake system. Overfilling the brake fluid reservoir



can result in spilling brake fluid on hot engine parts and the brake fluid catching fire. You can be seriously burned.

!
 If you find that the brake fluid in the brake fluid reservoir has fallen to the minimum mark or below, have the brake system checked for brake pad thickness and leaks.

!
 Brake pad thickness must be visually inspected by a qualified technician at the intervals specified in the Maintenance Booklet.

Practical hints

What to do if ...

Display symbol	Display messages	Possible cause	Possible solution
 (USA only)  (Canada only)	Visit workshop	There may be a malfunction in the: <ul style="list-style-type: none"> • Fuel injection system • Ignition system • Exhaust system • Fuel system 	<ul style="list-style-type: none"> ▶ Have the measuring system checked by an authorized Mercedes-Benz Light Truck Center.
	Coolant Check level	The coolant level is too low.	<ul style="list-style-type: none"> ▶ Add coolant (▷ page 332). ▶ If you have to add coolant frequently, have the cooling system checked by an authorized Mercedes-Benz Light Truck Center.

Warning!



Do not spill antifreeze on hot engine parts. Antifreeze contains ethylene glycol which may burn if it comes into contact with hot engine parts. You can be seriously burned.



Do not ignore the low engine coolant level warning. Extended driving with the message and symbol displayed may cause serious engine damage not covered by the Mercedes-Benz Limited Warranty.

Do not drive without sufficient amount of coolant in the cooling system. The engine will overheat causing major engine damage.

Practical hints
What to do if ...

Display symbol	Display messages	Possible cause	Possible solution
	Coolant Stop, engine off	The coolant is too hot.	<ul style="list-style-type: none"> ▶ Stop the vehicle and immediately turn off the engine. ▶ Only start the engine again after the message disappears. You could otherwise damage the engine.

Warning! 

Driving when your engine is badly overheated can cause some fluids which may have leaked into the engine compartment to catch fire. You could be seriously burned.

Steam from an overheated engine can cause serious burns and can occur just by opening the engine hood. Stay away from the engine if you see or hear steam coming from it.

Turn off the engine, get out of the vehicle and do not stand near the vehicle until the engine has cooled down.

During severe operation conditions and stop-and-go city traffic, the coolant temperature may rise close to 248°F (120°C).

 The engine should not be operated with the coolant temperature above 248°F (120°C). Doing so may cause serious damage which is not covered by the Mercedes-Benz Limited Warranty.



Practical hints

What to do if ...

Display symbol	Display messages	Possible cause	Possible solution
	Coolant Stop, engine off	The poly-V-belt could be broken.	<ul style="list-style-type: none"> ▶ Stop the vehicle and immediately turn off the engine. ▶ Check the poly-V-belt. If it is broken: <ul style="list-style-type: none"> ▶ Do not continue to drive. Otherwise the engine will overheat due to an inoperative water pump which may result in damage to the engine. Notify an authorized Mercedes-Benz Light Truck Center. If it is intact: <ul style="list-style-type: none"> ▶ Do not continue to drive the vehicle with this message displayed. Doing so could result in serious engine damage that is not covered by the Mercedes-Benz Limited Warranty. ▶ Drive immediately to the nearest authorized Mercedes-Benz Light Truck Center.
	Coolant Visit workshop	The cooling fan for the coolant is malfunctioning.	<ul style="list-style-type: none"> ▶ Observe the coolant temperature gauge in the instrument cluster. ▶ Have the fan replaced as soon as possible.

Practical hints

What to do if ...

Display symbol	Display messages	Possible cause	Possible solution
	Display malfunction Visit workshop	The instrument cluster display is malfunctioning. The displays for several systems have malfunctioned. Some systems themselves may also have malfunctioned.	<ul style="list-style-type: none"> ▶ Continue driving with added caution. ▶ Visit an authorized Mercedes-Benz Light Truck Center as soon as possible. ▶ Have the electronic systems checked by an authorized Mercedes-Benz Light Truck Center.
	Display malfunction Visit workshop	Certain electronic systems are unable to relay information to the control system. The following systems may have failed: <ul style="list-style-type: none"> • Coolant temperature display • Tachometer • Cruise control display 	▶ Have the electronic systems checked by an authorized Mercedes-Benz Light Truck Center.
	Doors open Door open	You are attempting to drive with one or more doors open.	▶ Close the doors.

Practical hints

What to do if ...

Display symbol	Display messages	Possible cause	Possible solution
	Check eng. oil level when next refueling	The engine oil level is too low.	▶ Check the engine oil level (▷ page 328) (ML 500 only), or (▷ page 330) (ML 350 only).
	USA only: Add 1 qt. engine oil when next refueling	The engine oil level is too low.	▶ Add engine oil (▷ page 331) and check the engine oil level (▷ page 328) (ML 500 only), or (▷ page 330) (ML 350 only).
	Canada only: Add 1 liter engine oil when next refueling	The engine oil level is too low.	▶ Add engine oil (▷ page 331) and check the engine oil level (▷ page 328) (ML 500 only), or (▷ page 330) (ML 350 only).
	Engine oil level Stop, engine off	There is no oil in the engine. There is a danger of engine damage.	▶ Carefully bring the vehicle to a halt as soon as possible. ▶ Turn off the engine. ▶ Add engine oil (▷ page 331) and check the engine oil level (▷ page 328) (ML 500 only), or (▷ page 330) (ML 350 only).
Engine oil level Reduce oil level	You have added too much engine oil. There is a risk of damaging the engine or the catalytic converter.	▶ Have oil siphoned or drained off. Observe all legal requirements with respect to its disposal.	

Display symbol	Display messages	Possible cause	Possible solution
	Engine oil level Visit workshop	The engine oil has dropped to a critical level.	<ul style="list-style-type: none"> ▶ Check the engine oil level (▷ page 328) (ML 500 only), or (▷ page 330) (ML 350 only) and add oil as required (▷ page 331). ▶ If you must add engine oil frequently, have the engine checked for possible leaks.
	Oil sensor malfunction Visit workshop	The measuring system is malfunctioning.	<ul style="list-style-type: none"> ▶ Have the measuring system checked by an authorized Mercedes-Benz Light Truck Center.

When the Add 1 qt. engine oil when next refueling (Canada: 1 liter) message appears while the engine is running and at operating temperature, the engine oil level has dropped to approximately the minimum level.

When this occurs, the warning will first come on intermittently and then stay on if the oil level drops further.



Visually check for oil leaks. If no obvious oil leaks are noted, drive to the nearest service station where the engine oil should be topped to the required level with an approved oil specified in the Factory Approved Service Products pamphlet.



The engine oil level warnings should not be ignored. Extended driving with the symbol displayed could result in serious engine damage that is not covered by the Mercedes-Benz Limited Warranty.

Practical hints

What to do if ...

Display symbol	Display messages	Possible cause	Possible solution
	Reserve fuel	The fuel level has dropped below the reserve mark.	▶ Refuel at the next gas station (▷ page 323).
	Check gas cap See Operator's Manual	A loss of pressure has been detected in the fuel system. The fuel cap may not be closed properly or the fuel system may be leaky.	▶ Check the fuel cap (▷ page 323). If it is not closed properly: ▶ Close the fuel cap. If it is closed properly: ▶ Have the fuel system checked by an authorized Mercedes-Benz Light Truck Center.
	Hood open Trunk open	You are driving with the hood or the tailgate open.	▶ Close the hood (▷ page 326) or the tailgate (▷ page 120).
	Key Check battery	The SmartKey with KEYLESS-GO* batteries are discharged.	▶ Change the batteries (▷ page 440).
	Please do not forget key	This display appears (for a maximum of 60 seconds) if the driver's door is opened with the engine shut off and no SmartKey in the starter switch. This message is only a reminder.	▶ Insert SmartKey in the starter switch. ▶ Take the SmartKey with KEYLESS-GO* with you when leaving the vehicle.

Practical hints

What to do if ...

Display symbol	Display messages	Possible cause	Possible solution
	Key not detected	<p>The SmartKey with KEYLESS-GO* is not recognized while the engine is running because</p> <ul style="list-style-type: none"> the SmartKey with KEYLESS-GO* is not in the vehicle there is strong radio-frequency interference 	<ul style="list-style-type: none"> ▶ Stop the vehicle as soon as it is safe to do so. ▶ Search for the SmartKey. <p>Otherwise the vehicle cannot be centrally locked nor can the engine be started again after the engine is stopped.</p>
	Key not detected	The SmartKey with KEYLESS-GO* is momentarily not recognized.	<ul style="list-style-type: none"> ▶ Change the position of the SmartKey in the vehicle. ▶ Operate the vehicle with the SmartKey in the starter switch if necessary.
	Remove key	You have forgotten to remove the SmartKey.	▶ Remove the SmartKey from the starter switch.
	Replace key Drive to workshop	There is no additional code available for SmartKey or SmartKey with KEYLESS-GO*.	▶ Visit an authorized Mercedes-Benz Light Truck Center as soon as possible.

Practical hints

What to do if ...

Display symbol	Display messages	Possible cause	Possible solution
	3rd brake lamp	The high mounted brake lamp is malfunctioning. This message will only appear if all light emitting diodes have stopped working.	► Visit an authorized Mercedes-Benz Light Truck Center as soon as possible.
	Brake lamp, left Substitute bulb on	The left brake lamp is malfunctioning. A substitute bulb is being used.	► Visit an authorized Mercedes-Benz Light Truck Center as soon as possible.
	Brake lamp, right Substitute bulb on	The right brake lamp is malfunctioning. A substitute bulb is being used.	► Visit an authorized Mercedes-Benz Light Truck Center as soon as possible.
	Display malfunction Visit workshop	The display for the lamps or the system is malfunctioning.	► Visit an authorized Mercedes-Benz Light Truck Center as soon as possible.
	Front foglamp, left	The left front fog lamp is malfunctioning.	► Replace the bulb as soon as possible.
	Front foglamp, right	The right front fog lamp is malfunctioning.	► Replace the bulb as soon as possible.
	Rear foglamp, left	The left rear fog lamp is malfunctioning.	► Replace the bulb as soon as possible.
	Rear foglamp, right	The right rear fog lamp is malfunctioning.	► Replace the bulb as soon as possible.

Practical hints

What to do if ...

Display symbol	Display messages	Possible cause	Possible solution
	Active headlamp currently unavailable	The active Bi-Xenon* headlamps system is malfunctioning.	► Visit an authorized Mercedes-Benz Light Truck Center as soon as possible.
	Active headlamps Substitute bulb on	The active Bi-Xenon* headlamps system is malfunctioning. Another light is being used.	► Visit an authorized Mercedes-Benz Light Truck Center as soon as possible.
	Active headlamps inoperative	The active Bi-Xenon* headlamps system is malfunctioning.	► Visit an authorized Mercedes-Benz Light Truck Center as soon as possible.
	Active headlamps Display malfunction	The active Bi-Xenon* headlamp system is malfunctioning.	► Visit an authorized Mercedes-Benz Light Truck Center as soon as possible.
	High beam, left	The left high beam lamp is malfunctioning.	► Replace the bulb as soon as possible.
	High beam, right	The right high beam lamp is malfunctioning.	► Replace the bulb as soon as possible.
	License plate lamp, left	The left license plate lamp is malfunctioning.	► Replace the bulb as soon as possible.
	License plate lamp, right	The right license plate lamp is malfunctioning.	► Replace the bulb as soon as possible.

Practical hints

What to do if ...

Display symbol	Display messages	Possible cause	Possible solution
	Light sensor Drive to workshop	The lamp sensor is malfunctioning. The headlamps switch on automatically.	<ul style="list-style-type: none"> ▶ In the control system, set lamp operation to manual mode. ▶ Switch on headlamps using the exterior lamp switch.
	Low beam, left	The left low beam lamp is malfunctioning.	▶ Visit an authorized Mercedes-Benz Light Truck Center as soon as possible.
	Low beam, right	The right low beam lamp is malfunctioning.	▶ Visit an authorized Mercedes-Benz Light Truck Center as soon as possible.
	Marker lamp, front left	The front left side marker lamp is malfunctioning.	▶ Replace the bulb as soon as possible.
	Marker lamp, front right	The front right side marker lamp is malfunctioning.	▶ Replace the bulb as soon as possible.
	Parking lamp, front left Substitute bulb on	The left parking lamps are malfunctioning. A substitute bulb is being used.	▶ Visit an authorized Mercedes-Benz Light Truck Center as soon as possible.
	Parking lamp, front right Substitute bulb on	The right parking lamps are malfunctioning. A substitute bulb is being used.	▶ Visit an authorized Mercedes-Benz Light Truck Center as soon as possible.

Practical hints

What to do if ...

Display symbol	Display messages	Possible cause	Possible solution
	Reverse lamp, left	The left reverse light is malfunctioning.	► Replace the bulb as soon as possible.
	Reverse lamp, right	The right reverse light is malfunctioning.	► Replace the bulb as soon as possible.
	Switch off lights	Lamps have been turned on although the SmartKey in the starter switch is in position 0 .	► Switch off the headlights.
	Tail lamp, left Substitute bulb on	The left tail lamp is malfunctioning. A substitute bulb is being used.	► Visit an authorized Mercedes-Benz Light Truck Center as soon as possible.
	Tail lamp, right Substitute bulb on	The right tail lamp is malfunctioning. A substitute bulb is being used.	► Visit an authorized Mercedes-Benz Light Truck Center as soon as possible.

Practical hints

What to do if ...

Display symbol	Display messages	Possible cause	Possible solution
	Turn signal, rear left Substitute bulb on	The left rear turn signal lamp is malfunctioning. A substitute bulb is being used.	► Replace the bulb as soon as possible.
	Turn signal, rear right Substitute bulb on	The right rear turn signal lamp is malfunctioning. A substitute bulb is being used.	► Replace the bulb as soon as possible.
	Turn signal, front left Substitute bulb on	The left front turn signal lamp is malfunctioning. A substitute bulb is being used.	► Replace the bulb as soon as possible.
	Turn signal, front right Substitute bulb on	The right front turn signal lamp is malfunctioning. A substitute bulb is being used.	► Replace the bulb as soon as possible.
	Turn signal in mirror, left	The left turn signal in the side mirror is malfunctioning. This message will only appear if all light emitting diodes have stopped working.	► Have the LEDs replaced as soon as possible.
	Turn signal in mirror, right	The right turn signal in the side mirror is malfunctioning. This message will only appear if all light emitting diodes have stopped working.	► Have the LEDs replaced as soon as possible.

Practical hints

What to do if ...

Display symbol	Display messages	Possible cause	Possible solution
	Please rectify tire pressure	The pressure is too low in one or more tires.	▶ Check and correct tire inflation pressure as required.
	Caution Tire defect	One or more tires are deflating. The respective tire is shown in the multifunction display.	▶ Carefully bring the vehicle to a halt, avoiding abrupt steering and braking maneuvers. ▶ If necessary, change the wheel.

Warning!



Do not drive with a flat tire. A flat tire affects the ability to steer or brake the vehicle. You may lose control of the vehicle. Continued driving with a flat tire will cause excessive heat build-up and possibly a fire.

Practical hints

What to do if ...

Display symbol	Display messages	Possible cause	Possible solution
	Check tires	<p>The tire pressure in one or more tires is already below the minimum value.</p> <p>The respective tire is shown in the multifunction display.</p>	<ul style="list-style-type: none"> ▶ Carefully bring the vehicle to a halt, avoiding abrupt steering and braking maneuvers. ▶ Check and adjust tire pressure as required. ▶ If necessary, change the wheel.

Warning!







Do not drive with a flat tire. A flat tire affects the ability to steer or brake the vehicle.

You may lose control of the vehicle. Continued driving with a flat tire will cause excessive heat build-up and possibly a fire.



Practical hints

What to do if ...

Display symbol	Display messages	Possible cause	Possible solution
	Seat belt system Drive to workshop	The seat belt system is malfunctioning.	▶ Visit an authorized Mercedes-Benz Light Truck Center as soon as possible.
	Service memory full See Operator's Manual	The maintenance service memory cannot save any more data.	▶ Have the service memory checked by an authorized Mercedes-Benz Light Truck Center.
	Close tilt/sliding sunroof	You have opened the driver's door with the SmartKey removed from the starter switch and the sliding portion of the tilt/sliding sunroof* open.	▶ Close the tilt/sliding sunroof* (> page 235).
	Close tilt/sliding sunroof	You have opened the driver's door with the SmartKey removed from the starter switch and the tilt portion of the tilt/sliding sunroof* open.	▶ Close the tilt/sliding sunroof* (> page 235).

Practical hints

What to do if ...

Display symbol	Display messages	Possible cause	Possible solution
	Malfunction Drive to workshop	One or more main functions of the Tele Aid* system are malfunctioning.	▶ Have the Tele Aid* system checked by an authorized Mercedes-Benz Light Truck Center.
	Battery Drive to workshop	The emergency power battery for the Tele Aid* system is malfunctioning. If the vehicle battery is also dead, Tele Aid* will not be operational.	▶ Have the Tele Aid* system checked by an authorized Mercedes-Benz Light Truck Center.
	Restraint sys. malfunction Drive to workshop	The system is malfunctioning.	▶ Drive with added caution to the nearest authorized Mercedes-Benz Light Truck Center.

Warning!





In the event a malfunction of the SRS is indicated as outlined above, the SRS may not be operational.

For your safety, we strongly recommend that you visit an authorized Mercedes-Benz

Light Truck Center immediately to have the system checked; otherwise the SRS may not be activated when needed in an accident, which could result in serious or fatal injury, or it might deploy unexpectedly and unnecessarily which could also result in injury.

Practical hints

What to do if ...

Display symbol	Display messages	Possible cause	Possible solution
	Call failed	This message may appear if a phone connection cannot be established.	
	Tailgate open	This message will appear whenever the tailgate is open.	▶ Close the tailgate (▷ page 120).
	Washer fluid Check level	The fluid level has dropped to about $\frac{1}{3}$ of total reservoir capacity.	▶ Add washer fluid (▷ page 333).

Practical hints

What to do if ...

Display symbol	Display messages	Possible cause	Possible solution
	Vehicle being raised	Your vehicle is adjusting to your level selection.	
	Level selec. canceled	You have select another vehicle level.	
		You are driving too fast for the selected level.	<ul style="list-style-type: none"> ▶ Reduce vehicle speed. ▶ Set the desired vehicle level again (▷ page 250).
	Visit workshop	<p>The system is functional only to a limited extent.</p> <p>The system display or the system is malfunctioning.</p>	<ul style="list-style-type: none"> ▶ Do not drive faster than 50 mph (80 km/h) depending on the set vehicle level. ▶ Have the vehicle checked at an authorized Mercedes-Benz Light Truck Center.
	<p>Max. speed 20 mph</p> <p>Drive with extreme care</p>	You are driving too fast for the desired level selection.	<ul style="list-style-type: none"> ▶ Reduce vehicle speed under 20 mph.

Practical hints

What to do if ...

Display symbol	Display messages	Possible cause	Possible solution
	Level selection not permitted	You are driving too fast for the desired level selection.	<ul style="list-style-type: none"> ▶ Reduce vehicle speed. ▶ Set the next higher level selection again (▷ page 250).
	Compressor cooling down	Level control was activated too long/too frequently.	<ul style="list-style-type: none"> ▶ Let the compressor cool until the message disappears. <p>The selected level will be set once the compressor has cooled.</p>
	Visit workshop	The system display is malfunctioning.	<ul style="list-style-type: none"> ▶ Do not drive faster than 50 mph (80 km/h) depending on the set vehicle level. ▶ Have the vehicle checked at an authorized Mercedes-Benz Light Truck Center.



When the message Compressor cooling down appears in the multifunction display, driving is still possible.

Keep in mind that the ride height of the vehicle is not yet reached, so you can damage the underbody of the vehicle.

The selected level will be set once the compressor has cooled.

Practical hints

Where will I find ...?

First aid kit

The first aid kit is located on the driver's side in the cargo compartment behind the cover.



① Handle

- ▶ Turn handles ① 90°.
- ▶ Fold down the cover.

The first aid kit can be removed.



Check expiration dates and contents for completeness at least once a year and replace missing/expired items.

Vehicle tool kit

The vehicle tool kit is stored under the cargo compartment floor.

The vehicle tool kit includes:

- Towing eye bolt
- Wheel wrench
- Alignment bolt
- Vehicle jack
- Fuse chart
- Spare fuses
- Fuse extractor
- Collapsible wheel chock



① Handle

② Cargo compartment floor

- ▶ Open the tailgate (▷ page 118).
- ▶ Pull handle ①.
- ▶ Lift the cargo compartment floor ② and engage the elastic strap (located below the floor handle) in the upper edge of the cargo compartment.
- ▶ Remove Minispare wheel (▷ page 433).

You can then access the vehicle tool kit.



Trunk area shown with spare wheel removed

- ① Wheel bolt wrench with screwdriver
- ② Vehicle jack
- ③ Collapsible wheel chock
- ④ Spare fuses, fuse chart, fuse extractor
- ⑤ Towing eye bolt
- ⑥ Alignment bolt
- ⑦ Wheel bolts for 17" light alloy rims or Minispare wheel



Vehicles with scissors-type jack see separate instructions.

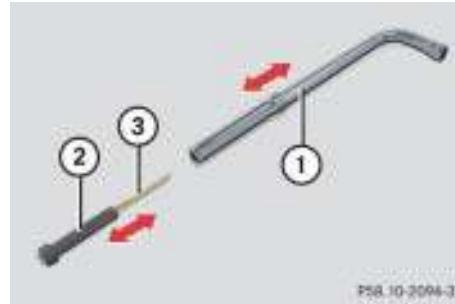

- ① Wheel bolt wrench
- ② Screwdriver
- ③ Interchangeable slot

Screwdriver ② is placed inside the handle of wheelbolt wrench ①.



To prevent damage, always disengage the elastic strap and lower the cargo compartment floor (▷ page 430) before closing the tailgate.

Practical hints

Where will I find ...?

Vehicle jack

Warning!



The jack is designed exclusively for jacking up the vehicle at the jack take-up brackets built into both sides of the vehicle. To help avoid personal injury, use the jack only to lift the vehicle during a wheel change. Never get beneath the vehicle while it is supported by the jack. Keep hands and feet away from the area under the lifted vehicle. Always firmly set parking brake and block wheels before raising vehicle with jack.

Do not disengage parking brake while the vehicle is raised. Be certain that the jack is always vertical (plumb line) when in use, especially on hills. Always try to use the jack on level surface.

Make sure that the jack arm is fully seated in the jack take-up bracket. Always lower the vehicle onto sufficient capacity jack-stands before working under the vehicle.

Practical hints

Where will I find ...?



Storage position

- ▶ Remove vehicle jack from its compartment.
- ▶ Turn crank handle in the direction of arrow as fast as it will go.

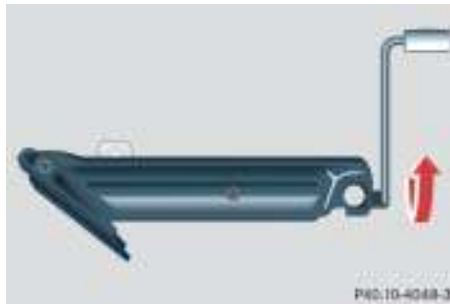

Operational position

- ▶ Turn crank handle clockwise.
- Before storing the vehicle jack in its compartment:
- It should be fully collapsed.
 - The handle must be folded in (storage position).

Setting up the collapsible wheel chock

The collapsible wheel chock serves to additionally secure the vehicle, e.g. while changing the wheel.

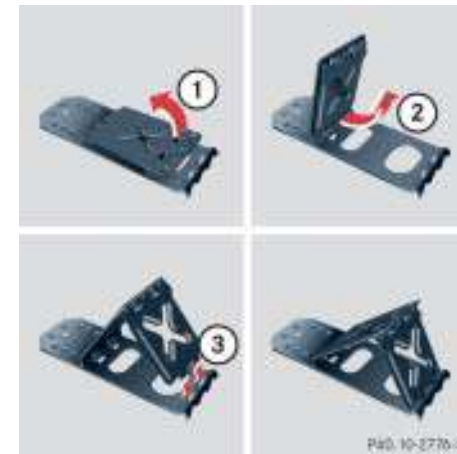

- ① Tilt the plate upward
- ② Fold the lower plate outward
- ③ Insert the plate

- ▶ Tilt both plates upward ①.
- ▶ Fold the lower plate outward ②.
- ▶ Guide the tabs of the lower plate all the way into the openings of base plate ③.

For information on where to place wheel chocks when changing a wheel, see “Lifting the vehicle” (▷ page 457).

Spare wheel

Minispare wheel

The Minispare wheel is located under the cargo compartment floor.



- ① Minispare wheel
- ② Towing eye bolt
- ③ Alignment bolt
- ④ Retaining screw
- ⑤ Wheel bolt wrench with screwdriver



Remove spare wheel to gain access to remaining tools in vehicle tool kit (▷ page 431).

Practical hints

Where will I find ...?

Warning!



The dimensions of the Minispare wheel are different from those of the road wheels. As a result, the vehicle handling characteristics change when driving with a mounted Minispare wheel.

- ▶ Open the tailgate (▷ page 118).
- ▶ Lift the cargo compartment floor (▷ page 430) and engage the elastic strap (located below the floor handle) in the upper edge of the cargo compartment.



To prevent damage, always disengage the elastic strap and lower the cargo compartment floor (▷ page 430) before closing the tailgate. ▷▷

Practical hints

Where will I find ...?

▷▷▶ Loosen retaining screw ③ by turning it counterclockwise.

▶ Remove Minispare wheel ①.

Use the Minispare wheel only temporarily, while observing the following restrictions:

- Do not exceed vehicle speed of 50 mph (80 km/h).
- Drive to the nearest repair facility to have the flat tire repaired or replaced as appropriate.
- Do not operate vehicle with more than one Minispare wheel mounted.



Please comply with the instructions for “Mounting the spare wheel” (▷ page 457).

Practical hints

Unlocking/locking in an emergency

▼ Unlocking/locking in an emergency

Unlocking the vehicle

If you cannot unlock the vehicle using the SmartKey or SmartKey with KEYLESS-GO*, open the driver's door using the mechanical key.



Unlocking your vehicle with the mechanical key will trigger the anti-theft alarm system.

To cancel the alarm, do one of the following:

- Press button or on the SmartKey.
- Insert the SmartKey in the starter switch.

In vehicles with KEYLESS-GO*:

- Grasp the outside door handle.
The SmartKey with KEYLESS-GO must be outside the vehicle.
- Press the KEYLESS-GO* start/stop button.
The SmartKey with KEYLESS-GO must be inside the vehicle.

Removing the mechanical key



SmartKey

- ① Mechanical key locking tab
- ② Mechanical key



SmartKey with KEYLESS-GO*

- ① Mechanical key locking tab
- ② Mechanical key

- ▶ Move locking tab ① in direction of arrow.
The mechanical key ② comes out.
- ▶ Slide the mechanical key ② out of housing.

Practical hints

Unlocking/locking in an emergency

Unlocking the driver's door



- ① Unlocking
- ② Mechanical key
- ▶ Insert the mechanical key ② into the driver's door lock until it stops.
- ▶ Turn the mechanical key ② counter-clockwise to position ①.
- ▶ Pull the door handle until the locking knob moves up (▷ page 117).
The driver's door is unlocked.
- ▶ Pull the door handle again to open the driver's door.

Locking the vehicle

If you cannot lock the vehicle using the SmartKey or KEYLESS-GO*, do the following:

- ▶ Close the passenger door, the rear doors and the tailgate.
- ▶ Press the lower part of the central locking switch in the door control panel (▷ page 126).
- ▶ Check to see whether the locking knobs on the doors have moved down.
- ▶ If necessary push them down manually.
Except for the driver's door, the vehicle should now be locked.



- ① Locking
- ② Mechanical key
- ▶ Remove the mechanical key out of the SmartKey (▷ page 435).
- ▶ Insert the mechanical key ② into the driver's door lock until it stops.
- ▶ Turn the mechanical key ② clockwise to position ①.
The driver's door is locked.

Practical hints

Unlocking/locking in an emergency

Unlocking and opening the tailgate

A minimum height clearance of 7 ft (2.15 m) is required to open the tailgate.

If the tailgate can no longer be unlocked and opened using the  button on the SmartKey or the KEYLESS-GO* function, use the manual release to unlock and open the tailgate.

The manual release is located on the inside of the tailgate.

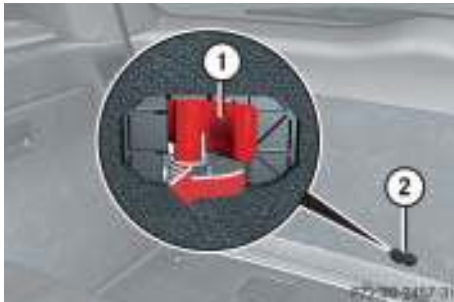

① Release lever

② Cover

- ▶ Remove cover ② from the trim on the tailgate.

- ▶ Push release lever ① all the way to the left.
- ▶ Lift the tailgate.





Always make sure there is sufficient overhead clearance.



If the vehicle has previously been locked from the outside using the SmartKey or SmartKey with KEYLESS-GO*, opening the tailgate from the inside will trigger the anti-theft alarm system.

To cancel the alarm, do one of the following:

With the SmartKey:

- Press button  or  on the SmartKey.
- Insert the SmartKey in the starter switch.

With KEYLESS-GO*:

- Grasp an outside door handle. The SmartKey with KEYLESS-GO must be within 3 ft (1 m) of the vehicle.
or
- Press the KEYLESS-GO start/stop button. The SmartKey with KEYLESS-GO must be inside the vehicle.

Practical hints

Unlocking/locking in an emergency

Fuel filler flap



Fuel filler flap release

- ▶ Open the tailgate (▷ page 118).
- ▶ Open cover in cargo compartment (▷ page 479) behind the right trim panel.
- ▶ Pull red fuel filler flap release in direction of arrow.

The fuel filler flap can now be opened.

▼ Opening/closing in an emergency

Power tilt/sliding sunroof*

You can open or close the tilt/sliding sunroof manually should an electrical malfunction occur.

The tilt/sliding sunroof drive is located behind the cover on the overhead control panel.



① Cover

- ▶ Remove the SmartKey from the starter switch.

Vehicles with SmartKey with KEYLESS-GO*

- ▶ Turn off the engine by pressing the KEYLESS-GO* once (▷ page 36).
- ▶ Open the driver's door (this puts the starter switch in position 0, same as with the SmartKey removed from the starter switch). The driver's door then can be closed again.
- ▶ Push cover ① at the location marked by the arrow.



② Crank

Practical hints

Opening/closing in an emergency

- ▶ Take crank ② out of the Operator's Manual pouch.
- ▶ Insert crank ② through hole.
- ▶ Turn crank ② clockwise to:
 - slide sunroof open
 - raise sunroof at the rear
- ▶ Turn crank ② counterclockwise to:
 - slide sunroof closed
 - lower sunroof at the rear

i

Turn crank ② slowly and smoothly.

The tilt/sliding sunroof must be synchronized if it has been operated manually (▷ page 237).

Practical hints

Replacing SmartKey batteries

If the batteries in the SmartKey or the SmartKey with KEYLESS-GO* are discharged, the vehicle can no longer be locked or unlocked. It is recommended to have the batteries replaced at an authorized Mercedes-Benz Light Truck Center.

Warning!



Keep the batteries out of reach of children.

If a battery is swallowed, seek medical help immediately.

Batteries contain materials that can harm the environment if disposed of improperly. Recycling of batteries is the preferred method of disposal. Many states require sellers of batteries to accept old batteries for recycling.



When inserting the batteries, make sure they are clean and free of lint.



When replacing batteries, always replace both batteries.

The required replacement batteries are available at any Mercedes-Benz Light Truck Center.

SmartKey

Replacement batteries: Lithium, type CR 2025 or equivalent.

- ▶ Remove mechanical key ① (▷ page 435).

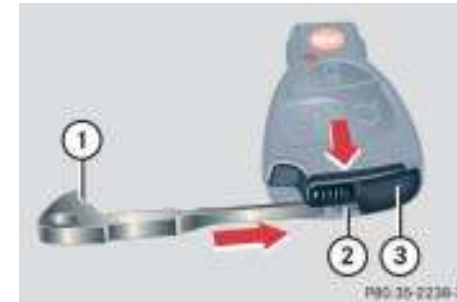

- ① Mechanical key
- ② Slide
- ③ Battery compartment

- ▶ Insert the mechanical key ① in direction of arrow in side opening.
- ▶ Using mechanical key ① push gray slide ② to unlatch battery compartment ③.
- ▶ Pull the battery compartment ③ out of the housing in direction of arrow.

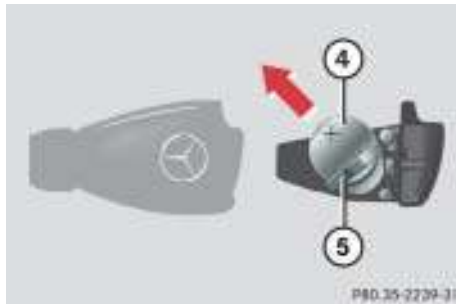

- ④ Battery
- ⑤ Contact spring

- ▶ Remove the batteries ④ in direction of arrow.
- ▶ Using a line-free cloth, insert new batteries ④ under the contact spring ⑤ with the plus (+) side facing up.
- ▶ Return battery compartment ③ into housing until it locks into place.
- ▶ Slide mechanical key ① back into the SmartKey.
- ▶ Check the operation of the SmartKey.

SmartKey with KEYLESS-GO*

Replacement batteries: Lithium, type CR 2025 or equivalent.

Remove mechanical key ① (> page 435).

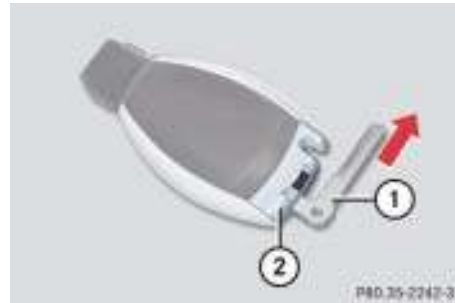

- ① Mechanical key
- ② Battery compartment

Practical hints

Replacing SmartKey batteries

- ▶ Insert mechanical key ① into opening and press mechanical key in direction of arrow.
The battery compartment ② is unlatched.
- ▶ Pull the battery compartment ② out of the SmartKey housing.



- ③ Battery
- ④ Contact spring

▷▷

Practical hints

Replacing SmartKey batteries

- ▷▷ Pull out batteries ③.
- ▶ Using a lint-free cloth, insert new batteries ③ with the plus (+) side facing up underneath the contact spring ④.
- ▶ Return battery compartment ② into housing until it locks into place.
- ▶ Slide mechanical key ① back into the SmartKey.
- ▶ Check the operation of the SmartKey and the KEYLESS-GO*.

▼ Replacing bulbs

Bulbs

Safe vehicle operation depends on proper exterior lighting and signaling. It is therefore essential that all bulbs and lamp assemblies are in good working order at all times.

Correct headlamp adjustment is extremely important. Have headlamps checked and readjusted at regular intervals. See an authorized Mercedes-Benz Light Truck Center for headlamp adjustment.



Substitute bulbs will be brought into use when the following lamps malfunction:

- Brake lamps
- Parking lamps
- Turn signal lamps
- Tail lamps

Observe the messages in the multi-function display (▷ page 418).

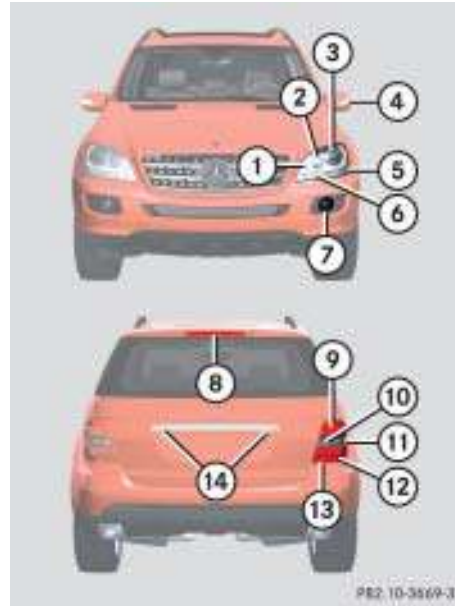

If the headlamps or front fog lamps are fogged up on the inside as a result of high humidity, driving the vehicle a distance with the lights on should clear up the fogging.

Practical hints

Replacing bulbs

Front lamps

	Lamp	Type
①	Parking and standing lamp	W 5 W
②	High beam/high beam flasher lamp	H7 (55 W)
③	Low beam ¹	H7 (55 W) Bi-Xenon*: D2S-35 W
④	Additional turn signal lamp	LED
⑤	Side marker lamp	WY 5 W
⑥	Turn signal lamp	3457 AK S-8 (30/2.2 cp bulb)
⑦	Front fog lamp	H11 (55 W)

¹ Vehicles with Bi-Xenon headlamps*: Do not replace the Bi-Xenon bulbs yourself. See your authorized Mercedes-Benz Light Truck Center.

Practical hints

Replacing bulbs

Rear lamps

	Lamp	Type
⑧	High mounted brake lamp	LED
⑨	Brake lamp	P 21 W
⑩	Backup lamp	P 21 W
⑪	Turn signal lamp	PY 21 W
⑫	Side marker lamp	P 21/4 W
⑬	Tail, parking, standing lamp, rear fog lamp (only driver's side)	P 21/4 W
⑭	License plate lamps	C 5 W

Warning!



Bulbs and bulb sockets can be very hot. Allow the lamp to cool down before changing a bulb.

Keep bulbs out of reach of children.

Halogen lamps contain pressurized gas.

A bulb can explode if you:

- touch or move it when hot
- drop the bulb
- scratch the bulb

Wear eye and hand protection.

Because of high voltage in Xenon lamps, it is dangerous to replace the bulb or repair the lamp and its components. We recommend that you have such work done by a qualified technician.

Notes on bulb replacement

- Only use 12 volt bulbs of the same type and with the specified watt rating.
- Switch lights off before changing a bulb to prevent short circuits.
- Always use a clean lint-free cloth when handling bulbs.
- Your hands should be dry and free of oil and grease.
- If the newly installed bulb does not come on, visit an authorized Mercedes-Benz Light Truck Center.

Have the LEDs and bulbs for the following lamps replaced by an authorized Mercedes-Benz Light Truck Center:

- Additional turn signals in the exterior rear view mirrors
- Bi-Xenon lamps*
- Front fog lamps (vehicles with sport package*)
- High mounted brake lamp

Replacing bulbs for front lamps

Before you start to replace a bulb for a front lamp, do the following first:

- ▶ Turn the exterior lamp switch to position **0** (▷ page 138).
- ▶ Open the hood (▷ page 326).

Practical hints

Replacing bulbs

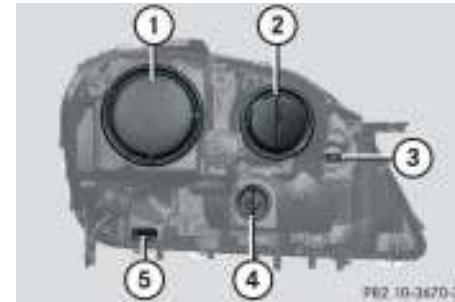

- ① Housing cover for low beam halogen or Bi-Xenon* headlamp
- ② Housing cover for high beam halogen bulb (vehicles with halogen bulbs: high beam and high beam flasher; vehicles with Bi-Xenon* headlamps: high beam flasher only)
- ③ Bulb socket for parking and standing lamp bulb
- ④ Bulb socket for turn signal lamp bulb
- ⑤ Bulb socket for side marker lamp bulb

Practical hints

Replacing bulbs

Replacing low beam bulbs



① Housing cover for low beam halogen or Bi-Xenon* headlamp

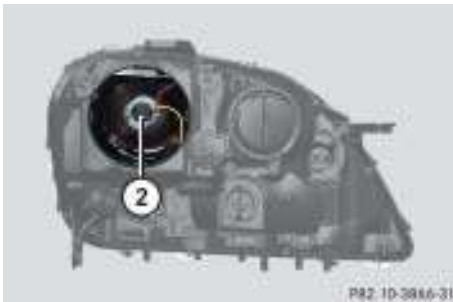

② Electrical connector for low beam headlamp bulb (halogen headlamps only)

Bi-Xenon* headlamp

Warning!



Do not remove the cover ① for the Bi-Xenon* headlamp. Because of high voltage in Xenon* lamps, it is dangerous to replace the bulb or repair the lamp and its components. We recommend that you have such work done by a qualified technician.

Low beam halogen headlamp

- ▶ Turn housing cover ① counterclockwise and remove it.
- ▶ Turn electrical connector ② with bulb counterclockwise out of housing.
- ▶ Remove old bulb from connector.
- ▶ Insert the new bulb so that its socket locates in the recess of the lamp housing.
- ▶ Place electrical connector ② with bulb into housing and turn clockwise.
- ▶ Align housing cover ① and turn it clockwise.

Practical hints

Replacing bulbs

Replacing high beam halogen bulb, parking and standing lamp

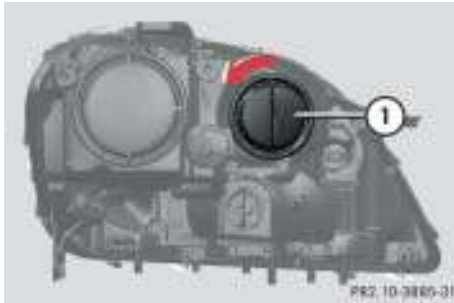

- ① Housing cover for high beam halogen bulb (vehicles with halogen bulbs: high beam and high beam flasher; vehicles with Bi-Xenon* headlamps: high beam flasher only), parking and standing lamp

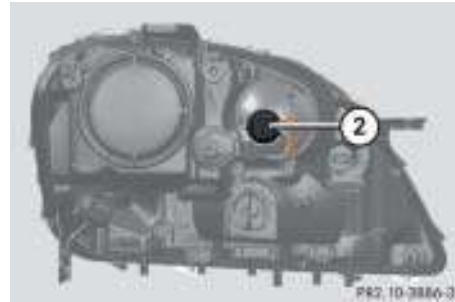

- ② Electrical connector for high beam halogen bulb (vehicles with halogen bulbs: high beam and high beam flasher; vehicles with Bi-Xenon* headlamps: high beam flasher only)

High beam halogen bulb

- ▶ Turn housing cover ① counterclockwise and remove it.
- ▶ Turn electrical connector ② with bulb counterclockwise out of housing.
- ▶ Remove old bulb from connector.
- ▶ Insert the new bulb so that its socket locates in the recess of the lamp housing.
- ▶ Place electrical connector ② with bulb into housing and turn clockwise.
- ▶ Align housing cover ① and turn it clockwise.

Practical hints

Replacing bulbs

Parking/standing lamp bulb

- ▶ Turn bulb socket ③ counterclockwise and remove it (▷ page 445).
- ▶ Pull out bulb socket ③ with the bulb.
- ▶ Press gently onto the bulb and turn counterclockwise out of bulb socket ③.
- ▶ Press the new bulb gently into bulb socket ③ and turn clockwise until it engages.
- ▶ Press bulb socket ③ back into the lamp.
- ▶ Align bulb socket ③ and turn it clockwise.

Turn signal bulb

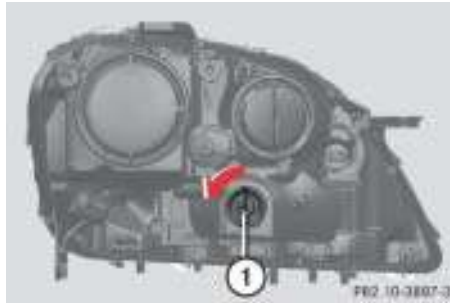

- ① Bulb socket
- ▶ Turn bulb socket ① counterclockwise and pull it out.
- ▶ Press the new bulb gently into socket ①, turn socket counterclockwise and remove it.
- ▶ Insert the new bulb in socket ①, push and turn the bulb clockwise.
- ▶ Align bulb socket ① and turn bulb socket clockwise.

Side marker lamp bulb

- ▶ Turn bulb socket ⑤ counterclockwise and remove it (▷ page 445).
- ▶ Pull out bulb socket ⑤ with the bulb.
- ▶ Press gently onto the bulb and turn counterclockwise out of bulb socket ⑤.
- ▶ Press the new bulb gently into bulb socket ⑤ and turn clockwise until it engages.
- ▶ Press bulb socket ⑤ back into the lamp.
- ▶ Align bulb socket ⑤ and turn it clockwise.

Front fog lamp



If not done carefully and properly, damage to the bumper can result. We therefore recommend that you have this work carried out by an authorized Mercedes-Benz Light Truck Center.

Remove front fog lamp cover (ML 350, ML 500):



- ① Cover
- ② Front fog lamp

- ▶ Use a suitable object (e.g. screwdriver) to press on the release lever behind the front panel.

Cover ① releases.

- ▶ Pull cover ① out of the bumper.

Remove front fog lamp cover (ML 350, ML 500 with AMG Sport Package):



- ① Cover
- ② Front fog lamp

- ▶ Use a suitable object (e.g. hook or a screwdriver) and place the hook or screwdriver carefully between lower end of cover and bumper.

Practical hints

Replacing bulbs

- ▶ Turn the hook or screwdriver 90°.
- ▶ Hold the cover ① and pull the hook or screwdriver outwards.



Example ML 350, ML 500 without Sport Package; Sport Package similar

- ③ Screw
- ▶ Turn the screws ③ counterclockwise.
- ▶ Pull the front fog lamp ② out of the bumper.
- ▶ Pull electrical connector off. >>

Practical hints

Replacing bulbs



- ④ Bulb socket of front fog lamp bulb
- ▶ Turn bulb socket ④ with the bulb counterclockwise and remove it.
- ▶ Insert new bulb socket ④ with the bulb into the lamp and turn it clockwise.
- ▶ Plug electrical connector onto the bulb socket ④.
- ▶ Reinstall front fog lamp ② into the bumper.
- ▶ Reinstall cover ① into the bumper until it engages.

Replacing bulbs for rear lamps

Before you start to replace a bulb for a rear lamp, do the following first:

- ▶ Turn the exterior lamp switch to position **0** (▷ page 138).
- ▶ Open the tailgate.
- ▶ Open the cover in the cargo compartment.

For the driver's side rear lamps, see "First aid kit" (▷ page 430).

For the passenger-side rear lamps, see "Fuse box in cargo compartment" (▷ page 479).

Vehicles without sound system*:

- ▶ Remove the additional cover on the driver's side.



- ① Screw
- ▶ Turn the screws ① 90° counterclockwise and remove the storage bin.

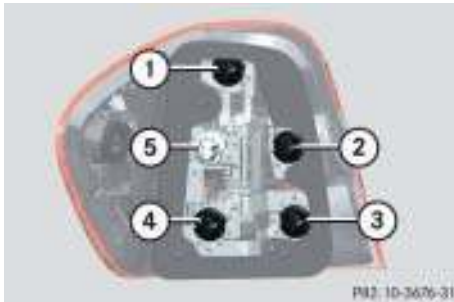

Example rear lamp passenger-side

- ① Brake lamp
 - ② Backup lamp
 - ③ Rear fog lamp (only driver's side), tail lamp, parking and standing lamp
 - ④ Side marker lamp
 - ⑤ Turn signal lamp
- ▶ Turn the respective bulb socket with the bulb counterclockwise and remove it.
 - ▶ Press gently onto the respective bulb and turn counterclockwise out of its bulb socket.

- ▶ Press the new bulb gently into its bulb socket and turn clockwise until it engages.
- ▶ Align bulb socket and turn it clockwise.

License plate lamp



- ① License plate lamp cover
 - ② Screw
- ▶ Loosen both screws ②.
 - ▶ Remove license plate lamp cover ①.
 - ▶ Replace the tubular bulb.
 - ▶ Reinstall license plate lamp cover ①.
 - ▶ Retighten screws ②.

Practical hints

Replacing bulbs

Adjusting headlamp aim

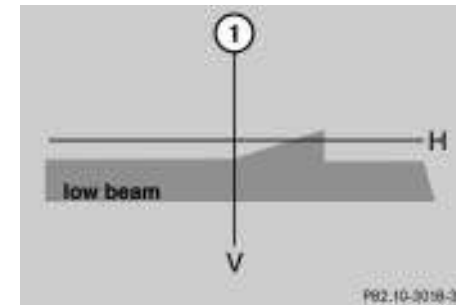

V Vertical centerline

H Headlamp mounting high, measured from the center



High beam adjustments simultaneously aim the low beam.

Vehicle should have a normal tailgate load.

Practical hints

Replacing bulbs

Correct headlamp adjustment is extremely important. To check and readjust a headlamp, follow the steps described:

- ▶ Park the vehicle on a level surface 25 feet (7.6 m) from a vertical test screen or wall.
- ▶ Switch the headlamps on (▷ page 138).

If the beam does not show a beam pattern as indicated in the figure left, then follow the steps below:

- ▶ Open hood (▷ page 326).



- ② Headlamp vertical adjustment screw
- ③ Headlamp vertical adjustment screw

- ▶ Always turn adjustment screws ② and ③ simultaneously for vertical adjustment until the headlamp is adjusted as shown ①. Turn clockwise for upward movement and counterclockwise for downward movement.

Graduations:

screw ②: 0.50° pitch

screw ③: 0.67° pitch

The left and right headlamps must be adjusted individually.



If it is not possible to obtain a proper headlamp adjustment, have the system checked at an authorized Mercedes-Benz Light Truck Center.

▼ Replacing wiper blades

Warning!



For safety reasons, switch off wipers and remove SmartKey from starter switch (vehicles with KEYLESS-GO*: Make sure the vehicle's on-board electronics have status **0**) before replacing a wiper blade. Otherwise the motor could suddenly turn on and cause injury.

Removing front wiper blades

- ▶ Fold wiper arm forward until it engages.



- ① Wiper blade
- ② Cover
- ③ Attachment
- ④ Tab
- ⑤ Removing

- ▶ Press tabs ④ together and tilt wiper blade ① to detach tabs ④ on both recesses of attachment ③.
Wiper blade ① is released on one end.
- ▶ Maintaining its tilted position, slide wiper blade ① out of attachment ③ in direction of arrow ⑤.

Practical hints

Replacing wiper blades

Installing front wiper blades



- ① Installing
- ② Tab
- ③ Attachment
- ④ Guide tab
- ⑤ Cover

- ▶ Slide the wiper blade into attachment ③ in direction of arrow ①.
- ▶ Make sure guide tab ④ will be placed under cover ⑤ when fully inserting the wiper blade into attachment. ▷▷

Practical hints

Replacing wiper blades

- ▷▷▶ Let tab ② latch into both recesses of attachment ③.
- ▶ Check if the wiper blade is securely fastened.
- ▶ Fold the wiper arm backward to rest on the windshield.
Make sure you hold on to the wiper arm when folding it back.



Never open the hood when the wiper arms are folded forward.

Hold on to the wiper when folding the wiper arm back. If released, the force of the impact from the tensioning spring could crack the windshield.

Do not allow the wiper arms to contact the windshield glass without a wiper blade inserted.

Make certain that the wiper blades are properly installed. Improperly installed wiper blades may cause windshield damage.

For your convenience, we recommend that you have this work carried out by an authorized Mercedes-Benz Light Truck Center.

Removing rear wiper blade

Warning!



For safety reasons, switch off wipers and remove SmartKey from starter switch (vehicles with KEYLESS-GO*: Make sure the vehicle's on-board electronics have status **0**) before replacing a wiper blade. Otherwise the motor could suddenly turn on and cause injury.

- ▶ Fold wiper arm ① (▷ page 455) forward until it engages.

Practical hints

Replacing wiper blades



- ① Wiper arm
- ② Wiper blade

- ▶ Turn the wiper blade ② at a right angle to wiper arm.
- ▶ Hold wiper arm ① and disengage wiper blade ② by pushing it in direction of arrow.
- ▶ Remove wiper blade ②.

Installing rear wiper blade



- ① Wiper arm
- ② Wiper blade

- ▶ Insert wiper blade ② onto wiper arm ①.
- ▶ Hold wiper arm ① and engage wiper blade ② by pushing it in direction of arrow until it locks into place.

- ▶ Check if the wiper blade is securely fastened.
- ▶ Fold the wiper arm backward to rest on the rear windshield.
Make sure you hold on to the wiper arm when folding it back.

Practical hints

Flat tire

Warning!



The dimensions of the Minispare wheel are different from those of the road wheels. As a result, the vehicle handling characteristics change when driving with a mounted Minispare wheel. Adapt your driving style accordingly.

The Minispare wheel is for temporary use only. When driving with a Minispare wheel mounted, ensure proper tire pressure and do not exceed a vehicle speed of 50 mph (80 km/h).

Drive to the nearest Mercedes-Benz Light Truck Center as soon as possible to have the Minispare wheel replaced with a regular road wheel.

Never operate the vehicle with more than one spare wheel mounted.

Do not switch off the ESP[®] when a Minispare wheel is mounted.

Preparing the vehicle

- ▶ Park the vehicle as far as possible from moving traffic on a hard surface.
- ▶ Turn on the hazard warning flashers.
- ▶ Turn the steering wheel so that the front wheels are in a straight ahead position.
- ▶ Set the parking brake.
- ▶ Shift automatic transmission to park position **P**.

Vehicles with Air suspension package*:

- ▶ Do not open or close a door or tailgate while mounting the spare wheel.

Vehicles with SmartKey:

- ▶ Turn off the engine (▷ page 34).
- ▶ Remove the SmartKey from the starter switch.

Vehicles with KEYLESS-GO*:

- ▶ Turn off the engine by pressing the KEYLESS-GO* button once (▷ page 63).
- ▶ Open the driver's door (this puts the starter switch in position **0**, same as with the SmartKey removed from the starter switch). The driver's door then can be closed again.
- ▶ Have any passenger exit the vehicle at a safe distance from the roadway.



Open doors only when conditions are safe to do so.

Mounting the spare wheel

Preparing the vehicle

- ▶ Prepare the vehicle as described (▷ page 456).
- ▶ Take the wheel wrench, the collapsible wheel chock, and the vehicle jack out of the cargo compartment (▷ page 430).



Vehicles with factory-mounted running-boards*:

Your vehicle is equipped with a scissors-type jack (located under the cargo compartment floor) designed for use with factory-mounted running boards. Only use this jack when jacking up vehicles with factory-mounted running boards as otherwise the vehicle's underbody can be damaged. See separate instructions for scissors-type jack.

- ▶ Take the Minispare wheel out of the cargo compartment (▷ page 433).

Lifting the vehicle

- ▶ Prevent the vehicle from rolling away by blocking wheels with wheel chocks or other sizable objects.

A collapsible wheel chock is included with the vehicle tool kit (▷ page 430). For information on setting up the collapsible wheel chock, see (▷ page 432).

When changing wheel on a level surface:

- ▶ Place one wheel chock in front of and another sizeable object behind the wheel that is diagonally opposite to the wheel being changed.

Always try lifting the vehicle using the jack on a level surface. However, should circumstances require you to do so on a hill, place the wheel chock and other sizeable object as follows:

- ▶ Place the wheel chock and another sizable object on the downhill side blocking both wheels of the axle not being worked on.

Practical hints

Flat tire

Warning!



The jack is designed exclusively for jacking up the vehicle at the jack take-up brackets built into both sides of the vehicle. To help avoid personal injury, use the jack only to lift the vehicle during a wheel change. Never get beneath the vehicle while it is supported by the jack. Keep hands and feet away from the area under the lifted vehicle. Always firmly set parking brake and block wheels before raising vehicle with jack.

Do not disengage parking brake while the vehicle is raised. Be certain that the jack is always vertical (plumb line) when in use, especially on hills. Always try to use the jack on level surface. Make sure that the jack arm is fully seated in the jack take-up bracket. Always lower the vehicle onto sufficient capacity jackstands before working under the vehicle.

Practical hints

Flat tire



- ▶ On wheel to be changed, loosen but do not yet remove the wheel bolts (approximately one full turn with wrench).

The jack take-up brackets are located directly behind the front wheel housings and in front of the rear wheel housings.



Do not position the jack on the body of the vehicle, as this may cause damage to the vehicle.



- ① Take-up bracket
- ② Jack



Vehicles with factory-mounted running-boards*:

Your vehicle is equipped with a scissors-type jack (located under the cargo compartment floor) designed for use with factory-mounted running boards. Only use this jack when jacking up vehicles with factory-mounted running boards as otherwise the vehicle's underbody can be damaged. See separate instructions for scissors-type jack.

- ▶ Place jack ② on firm ground.
- ▶ Position jack ② under the take-up bracket ① so that it is always vertical (plumb-line) as seen from the side, even if the vehicle is parked on an incline.

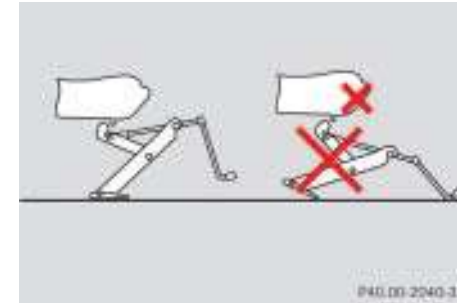

- ▶ Jack up the vehicle until the wheel is a maximum of 1.2 in (3 cm) from the ground. Never start engine while vehicle is raised.

Practical hints

Flat tire

Warning!



The jack is intended only for lifting the vehicle briefly for wheel changes. It is not suited for performing maintenance work under the vehicle.

- Never start the engine when the vehicle is raised.
- Never lie down under the raised vehicle.

Removing the wheel



① Alignment bolt

- ▶ Unscrew upper-most wheel bolt and remove it.
- ▶ Replace this wheel bolt with alignment bolt ① supplied with the tool kit (▷ page 430).
- ▶ Remove the remaining bolts.



Do not place wheel bolts in sand or dirt. This could result in damage to the bolts and wheel hub threads.

- ▶ Remove the wheel.

Mounting the new wheel

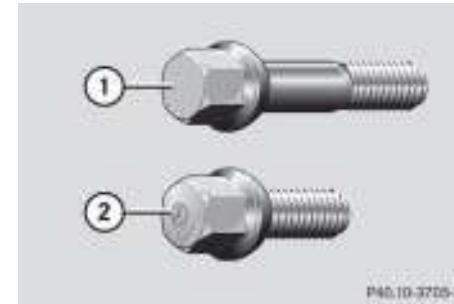

- ① Wheel bolt for 18" and 19" light alloy rims*
- ② Wheel bolt for 17" light alloy rims or Minispare wheel (located in vehicle tool kit (▷ page 431))



Wheel bolts ② must be used when mounting 17" light alloy rims or the Minispare wheel. The use of any wheel bolts other than wheel bolts ② for 17" light alloy rims or the Minispare wheel will physically damage the vehicle's brakes.



Practical hints

Flat tire

- ▷▷ Clean contact surfaces of wheel and wheel hub.



To avoid paint damage, place wheel flat against hub and hold it there while installing first wheel bolt.

Warning!



Always replace wheel bolts that are damaged or rusted.

Never apply oil or grease to wheel bolts.

Damaged wheel hub threads should be repaired immediately. Do not continue to drive under these circumstances! Contact an authorized Mercedes-Benz Light Truck Center or call Roadside Assistance.

Incorrect wheel bolts or improperly tightened wheel bolts can cause the wheel to come off. This could cause an accident. Make sure to use the correct wheel bolts.



- ▶ Guide spare wheel onto the alignment bolt and push it on the wheel hub.
- ▶ Insert wheel bolts and tighten them slightly.
- ▶ Unscrew the alignment bolt.
- ▶ Insert the remaining wheel bolt and tighten it slightly.

Warning!



Use only genuine equipment Mercedes-Benz wheel bolts. Other wheel bolts may come loose.

Do not tighten the wheel bolts when the vehicle is raised. Otherwise the vehicle could fall off the jack.

Lowering the vehicle

- ▶ Lower vehicle by turning crank counterclockwise until vehicle is resting fully on its own weight.
- ▶ Remove the jack.



①-⑤ Wheel bolts

- ▶ Tighten the five wheel bolts evenly, following the diagonal sequence illustrated (1 to 5), until all bolts are tight. Observe a tightening torque of 110 lb-ft (150 Nm).

- ▶ Store all vehicle tools back in the cargo compartment.
- ▶ Store the damaged road wheel in the cargo compartment.



The damaged road wheel cannot be stored in the wheel well under the cargo compartment floor, but should be transported in the cargo compartment wrapped in a protective cover supplied with the vehicle.

Warning!



Have the tightening torque checked after changing a wheel. The wheels could come loose if they are not tightened to a torque of 110 lb-ft (150 Nm).

Practical hints

Battery

The battery is located under the front passenger seat.

The battery should always be sufficiently charged in order to achieve its rated service life. Refer to Maintenance Booklet for battery maintenance intervals.

If you use your vehicle mostly for short-distance trips, you will need to have the battery charge checked more frequently.

When replacing the battery, always use batteries approved by Mercedes-Benz.

If you do not intend to operate your vehicle for an extended period of time, consult an authorized Mercedes-Benz Light Truck Center about steps you need to observe.



Observe all safety instructions and precautions when handling automotive batteries.



Risk of explosion



Keep flames or sparks away from battery. Do not smoke.



Battery acid is caustic. Do not allow it to come into contact with skin, eyes or clothing.

In case it does, immediately flush affected area with clean water and seek medical help if necessary.



Wear eye protection.



Keep children away.



Follow the instructions in this Operator's Manual.

Batteries contain materials that can harm the environment if disposed of improperly. Recycling of batteries is the preferred method of disposal. Many states require sellers of batteries to accept old batteries for recycling.



Mercedes-Benz recommends to replace the battery by an authorized Mercedes-Benz Light Truck Center.

Practical hints

Battery



The battery is a valve-regulated lead acid (VRLA) battery, also referred to as “fleece” battery. Such batteries do not require topping-up of the electrolyte level. VRLA batteries therefore do not have cell caps and the battery cover is non-removable. Do not attempt to open the battery as otherwise the battery will be damaged.

Even though VRLA batteries do not require topping-up of the electrolyte level and cannot be opened to check the electrolyte level, the battery condition must be checked periodically by performing a battery conductance test. Refer to Maintenance Booklet for battery condition testing intervals.

As with any other battery, the battery may discharge if the vehicle is not operated for an extended period of time. You can connect a battery maintenance charge unit tested and approved for use on your vehicle model or disconnect the battery to prevent battery discharge. Contact an authorized Mercedes-Benz Light Truck Center for more information.



The factory-equipped VRLA battery is leak-proofed. Only use a battery as replacement that has the same security features and is of identical size, voltage, and capacity as the factory-equipped battery.

The battery, the battery ventilation tube (▷ page 468) and the vent plug (▷ page 468) must always be securely installed when the vehicle is in operation.

Warning!



Jump starting must only be done using the jump-start contacts located in the engine compartment (▷ page 470).

Practical hints

Battery

Warning!



Failure to follow these instructions can result in severe injury or death.

Observe all safety instructions and precautions when handling automotive batteries (▷ page 462).

Never lean over batteries while connecting, you might get injured.

Battery fluid contains sulfuric acid. Do not allow this fluid to come in contact with eyes, skin or clothing. In case it does, immediately flush affected area with water and seek medical help if necessary.

A battery will also produce hydrogen gas, which is flammable and explosive. Keep flames or sparks away from battery, avoid improper connection of jumper cables, smoking etc.



Never loosen or detach battery terminal clamps while the engine is running or the SmartKey is in the starter switch. Otherwise the alternator and other electronic components could be severely damaged.

Have the battery checked regularly by an authorized Mercedes-Benz Light Truck Center.

Refer to Maintenance Booklet for maintenance intervals or contact your authorized Mercedes-Benz Light Truck Center for further information.

Warning!



Do not place metal objects on the battery as this could result in a short circuit.

Use leak-proof battery only to avoid the risk of acid burns in the event of an accident.

Disconnecting, removing, reinstalling and reconnecting the battery

Warning!



Disconnecting, removing, reinstalling and reconnecting the battery is a complicated and technically demanding procedure that also requires safety precautions to avoid the risk of injury. We strongly recommend that it be performed by a qualified technician only. Please read the instructions fully before beginning operation and only undertake it if you feel fully capable of performing all of the tasks involved as described in these instructions. Observe all safety instructions and precautions when handling automotive batteries (▷ page 462). Performing the tasks involved incorrectly can cause damage to the vehicle and impair the operating safety of the vehicle, and/or cause severe injury to you or others.

Practical hints

Battery



With a disconnected battery you will no longer be able to turn the SmartKey in the starter switch and pressing the KEYLESS-GO* start/stop button will have no effect.

Step 1 (Disconnecting)



If your battery is discharged, the vehicle must be jump started (▷ page 470) using the jump start contacts in the engine compartment, or an accessory battery charge unit* approved by Mercedes-Benz must be connected using the jump start contacts in the engine compartment (see separate instructions for the accessory battery charge unit*) before any of the following steps can be performed. If the battery cannot be jumped or charged, please contact an authorized Mercedes-Benz Light Truck Center.

- ▶ Turn off the engine and leave the ignition switched on (▷ page 34).
- ▶ Depress parking brake firmly and set automatic transmission to position **P**.
- ▶ Turn off all electrical consumers.
- ▶ Read and observe safety instructions and precautions (▷ page 462).
- ▶ Move the front passenger seat to the most forward position (▷ page 39).

Step 2 (Disconnecting)

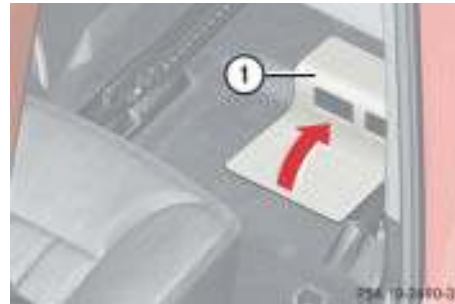

① Battery cover

- ▶ Enter the rear passenger compartment and remove main battery cover ①.

Step 3 (Disconnecting)

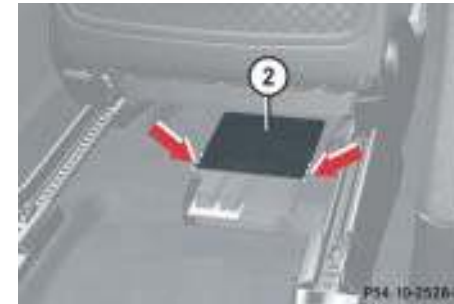

② Perforated floor carpet

- ▶ Cut the floor carpet ② along the dotted white line (see illustration) until you reach the perforated part. Start cutting at the point indicated by the arrows. Cut carpet using a sharp object (knife etc.).
- ▶ Enter the front passenger compartment.
- ▶ Move the front passenger seat to the most rearward position (▷ page 39).

Practical hints

Battery



- ▷▷ ② Perforated floor carpet, unfolded
- ▶ Fold the floor carpet piece ② in direction of the arrow.
- ▶ Move the front passenger seat to the most forward and upward position again (▷ page 39).
- ▶ Switch off the ignition (▷ page 34).

- ▶ Remove SmartKey from starter switch.

Vehicles with KEYLESS-GO*:

- ▶ Make sure the vehicle's on-board electronics have status **0** (Turn off the engine or all electrical systems using the KEYLESS-GO start/stop button. Open the driver's door. With the driver's door open, the vehicle's on-board electronics have status **0**, same as with the SmartKey removed from the starter switch).
- ▶ Enter the rear passenger compartment again.

Step 4 (Disconnecting)



- ③ Air channel
- ④ Clip
- ▶ Remove clip ④.
- ▶ Remove air channel ③ by pulling it out in direction of arrow.

Practical hints

Battery

Step 5 (Disconnecting)

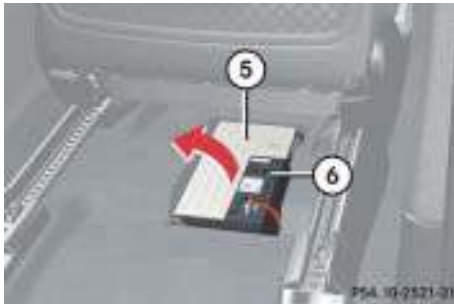

- ⑤ Protection cover
- ⑥ Battery

- ▶ Unclip protection cover ⑤ from battery ⑥ and remove it.

Step 6 (Disconnecting)

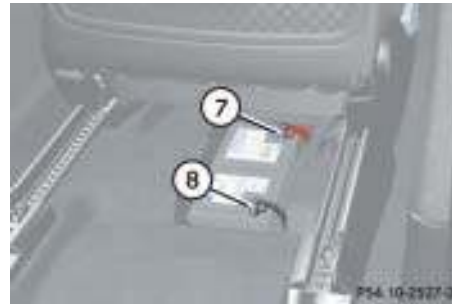

- ⑦ Positive terminal
- ⑧ Negative terminal

- ▶ Disconnect battery negative lead ⑧ from negative terminal.
- ▶ Remove positive terminal cover.
- ▶ Disconnect the battery positive lead ⑦.

Step 7 (Removing)

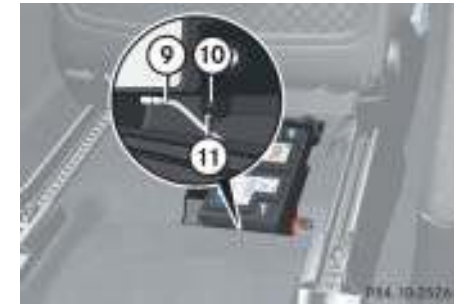

- ⑨ Battery ventilation tube
- ⑩ Attachment nut
- ⑪ Mounting

- ▶ Remove the battery ventilation tube ⑨ by pulling it out.
- ▶ Remove the battery attachment nuts ⑩ using a 6 mm T-handle hex key (not supplied with vehicle) with a shaft length of min. approx. 12 in (30 cm).
- ▶ Remove mounting ⑪.

Practical hints

Battery

Step 8 (Removing)



⑫ Battery

- ▶ Tilt the battery ⑫ with the negative terminal side upwards.
- ▶ Take out the battery maintaining its tilted position in the direction of the arrow.

Step 9 (Reinstalling)

- ▶ Carry out step 8 in reverse order (▷ page 468).



The battery, the battery ventilation tube ⑨ and the vent plug ⑬ must always be securely installed when the vehicle is in operation.



Battery, shown removed for illustration

- ⑨ Battery ventilation tube
- ⑬ Vent plug

- ▶ Carry out step 10 to reconnect the battery (▷ page 468).
- ▶ Follow steps 5 to 1 in reverse order to completely reinstall the battery (▷ page 467) to (▷ page 465).

Step 10 (Reconnecting)

- ▶ If the battery has been removed, first carry out step 8 in reverse order (▷ page 468).
- ▶ Open the driver's door.
- ▶ Make sure all electrical consumers are turned off.
- ▶ Make sure the SmartKey has been removed from the starter switch.

Vehicles with KEYLESS-GO*:

- ▶ Make sure the vehicle's on-board electronics have status **0** (Open the driver's door. With the driver's door open, the vehicle's on-board electronics have status **0**, same as with the SmartKey removed from the starter switch).

- ▶ Connect the positive lead and fasten its cover (▷ page 467).
- ▶ Connect the negative lead.



NEVER invert the terminal connections!



The following procedures must be carried out following any interruption of battery power (e.g. due to reconnection):

- Set the clock (▷ page 165) (see Modular COMAND system operator's manual).
- Resynchronize the power windows (▷ page 232).
- Resynchronize the power tilt/sliding sunroof* (▷ page 237).

Charging the battery

If the battery is discharged, the battery can be charged using the jump-start contacts located in the engine compartment (▷ page 471).

Warning!



Never charge a battery while still installed in the vehicle unless the accessory battery charge unit approved by Mercedes-Benz is being used. Gases may escape during charging and cause explosions that may result in paint damage, corrosion or personal injury.

An accessory battery charge unit specially adapted for Mercedes-Benz vehicles and tested and approved by Mercedes-Benz is available, permitting the charging of the battery in its installed position. Contact an authorized Mercedes-Benz Light Truck Center for information and availability. Charge battery in accordance with the separate instructions for the accessory battery charger.

- ▶ Charge the battery in accordance with the instructions of the battery charger manufacturer.

Batteries contain materials that can harm the environment if disposed of improperly. Large 12 volt storage batteries contain lead. Recycling of batteries is the preferred method of disposal. Many states require sellers of batteries to accept old batteries for recycling.

Practical hints

Jump starting

Warning!



Failure to follow these directions will cause damage to the electronic components, and can lead to a battery explosion and severe injury or death.

Never lean over batteries while connecting or jump starting, you might get injured.

Battery fluid contains sulfuric acid. Do not allow this fluid to come in contact with eyes, skin or clothing. In case it does, immediately flush affected area with water, and seek medical help if necessary.

A battery will also produce hydrogen gas, which is flammable and very explosive. Keep flames or sparks away from battery, avoid improper connection of jumper cables, smoking, etc.

Attempting to jump start a frozen battery can result in it exploding, causing personal injury.

Read all instructions before proceeding.

If the battery is discharged, the engine can be started with jumper cables and the battery of another vehicle. Observe the following:

- Jump starting should only be performed using the jump-start contacts located in the engine compartment.
 - Jump starting should only be performed when the engine and catalytic converter are cold.
 - Do not start the engine if the battery is frozen. Let the battery thaw out first.
 - Only jump start from batteries with the same voltage rating (12 V). Jump starting with a more powerful battery could damage the vehicle's electrical system, which will not be covered by the Mercedes-Benz Limited Warranty.
 - Only use jumper cables with sufficient cross-section and insulated terminal clamps.
- Always make sure the jumper cables are not on or near pulleys, fans or other parts that move when the engine is started or running.



Avoid repeated and lengthy starting attempts.

Do not attempt to start the engine using a battery quick charge unit.

If the engine does not run after several unsuccessful starting attempts, have it checked at the nearest authorized Mercedes-Benz Light Truck Center.

Excessive unburned fuel generated by repeated failed starting attempts may damage the catalytic converter.

Make sure the jumper cables do not have loose or missing insulation.

Make sure the cable clamps do not touch any other metal part while the other end is still attached to a battery.

Warning!



Keep flames or sparks away from battery.
Do not smoke.

Observe all safety instructions and precautions when handling automotive batteries
(▷ page 462).

The jump-start contacts are located in the engine compartment.

- ▶ Make sure the two vehicles do not touch.
- ▶ Turn off all electrical consumers.
- ▶ Apply parking brake.
- ▶ Shift gear selector lever to position **P**.



Never invert the terminal connections!



① Negative (-) terminal

② Cover of Positive (+) terminal

- ▶ Open cover ② of the positive terminal of both vehicles.
- ▶ Connect positive terminal ② and the positive terminal of the charged battery with the jumper cable. Clamp cable to charged battery first.
- ▶ Start engine of the vehicle with the charged battery and run at idle speed.
- ▶ Connect negative terminals ① and the negative terminal of the charged battery with the jumper cable. Clamp cable to charged battery first.

Practical hints

Jump starting

- ▶ Start the engine of the disabled vehicle.



The message **Undervoltage - Switch off consumers** may appear in the instrument cluster. It will disappear as soon as the battery is sufficiently charged.

Now you can again turn on the electrical consumers. Do not turn on the lights under any circumstances.

- ▶ Remove the jumper cables first from the negative terminals on each battery and then from the positive terminals on each battery.

Now you can turn on the lights.

- ▶ Have the battery checked at the nearest authorized Mercedes-Benz Light Truck Center.



Do not tow-start the vehicle.

Practical hints

Towing the vehicle

Mercedes-Benz recommends that the vehicle be transported with all wheels off the ground using flatbed or appropriate wheel lift/dolly equipment. This method is preferable to other types of towing.



Use flatbed or wheel lift/dolly equipment, with SmartKey in starter switch turned to position **0**.

Do not tow with sling-type equipment. Towing with sling-type equipment over bumpy roads will damage radiator and supports.

To prevent damage during transport, do not tie down vehicle by its chassis or suspension parts. Use the towing eyes.

Switch off the ESP[®] (▷ page 97), tow-away alarm (▷ page 102) and the automatic central locking (▷ page 125).

Do not tow-start the vehicle.

When circumstances do not permit the recommended towing methods, the vehicle may be towed with all wheels on the ground only so far as necessary to have the vehicle moved to a safe location where the recommended towing methods can be employed.



Do not tow with one axle raised. Doing so could damage the transfer case, which is not covered by the Mercedes-Benz Limited Warranty.

All wheels must be on or off the ground. Observe instructions for towing the vehicle with all wheels on the ground.



When towing the vehicle with all wheels on the ground, the gear selector lever must be in position **N** and the SmartKey must be in starter switch position **2**.

When towing the vehicle with all wheels on the ground, the vehicle may be towed only for distances up to 30 miles (50 km) and at a speed not to exceed 30 mph (50 km/h).

If the vehicle is towed with the front axle raised (observe instructions regarding flexible drive shaft), the engine must be shut off (SmartKey in starter switch position **1**). Otherwise, the 4-ETS may become engaged which may cause loss of towing control.

Keep in mind that it is important for the SmartKey to be in the respective starter switch positions as described above. As soon as the SmartKey is removed from the starter switch, the automatic transmission will shift to park position **P**.

Practical hints

Towing the vehicle



To be certain to avoid additional damage to the vehicle powertrain, however you should observe the following:

- With damage to the front axle
 - raise front axle
 - remove flexible drive shaft between rear axle and transfer case
- With damage to the rear axle
 - raise rear axle
 - tow vehicle with wheel lift or dolly placed under front wheels
- With damage to the transfer case
 - remove flexible drive shaft to the drive axles

Warning!



If circumstances require towing the vehicle with all wheels on the ground, always tow with a tow bar if:

- the engine will not run
- there is a malfunction in the power supply or in the vehicle's electrical system

as that will be necessary to adequately control the towed vehicle.

Prior to towing the vehicle with all wheels on the ground, make sure the SmartKey is in starter switch position **2**.

If the SmartKey is left in starter switch position **0** for an extended period of time, it can no longer be turned in the switch. In this case, the steering is locked. To unlock, remove SmartKey from starter switch and re-insert.

Warning!



With the engine not running, there is no power assistance for the brake and steering systems. In this case, it is important to keep in mind that a considerably higher degree of effort is necessary to brake and steer the vehicle. Adapt your driving accordingly.



To signal turns while being towed with hazard warning flasher in use, turn SmartKey in starter switch to position **2** and activate combination switch for left or right turn signal in usual manner – only the selected turn signal will operate.

Upon canceling the turn signal, the hazard warning flasher will operate again.

Practical hints

Towing the vehicle



The vehicle cannot be started via tow-start.



If the battery is disconnected or discharged, the automatic transmission will remain locked in position **P** and the SmartKey will not turn in the starter switch. For more information, see “Battery” (▷ page 462) and “Jump starting” (▷ page 470).



When towing the vehicle with all wheels on the ground, note the following:

With the automatic central locking activated and the SmartKey in starter switch position **2**, or KEYLESS-GO* start/stop button (▷ page 36) in position **2**, the vehicle doors lock if the left front wheel is turning at vehicle speeds of approximately 9 mph (15 km/h) or more.

Switch off the tow-away alarm (▷ page 102).

To prevent the vehicle doors from locking, deactivate the automatic central locking (▷ page 125).

Towing of the vehicle should only be done using the properly installed towing eye bolt. Never attach tow cable, tow rope or tow rod to vehicle chassis, frame or suspension parts.

Installing towing eye bolt



① Cover on passenger side of front bumper



① Cover on passenger side of rear bumper (ML 350)

Practical hints

Towing the vehicle



① Cover on passenger side of rear bumper (ML 500)

Warning!



In order to avoid possible serious burns or injury, use extreme caution when removing the rear cover, because the rear exhaust pipe is extremely hot.

Removing cover

ML 350

- ▶ Press mark on cover ① (▷ page 474) in direction of arrow.
- ▶ Lift cover off to reveal the threaded hole for towing eye bolt.

ML 500

- ▶ Pry cover ① (▷ page 475) with a screwdriver or similar tool.
- ▶ Lift cover off to reveal the threaded hole for towing eye bolt.

Installing towing eye bolt

- ▶ Take towing eye bolt and wheel bolt wrench out of cargo compartment (▷ page 430).
- ▶ Screw towing eye bolt clockwise into its stop and tighten with wheel wrench.

Removing towing eye bolt

- ▶ Loosen towing eye bolt counterclockwise with wheel wrench.
- ▶ Unscrew towing eye bolt.
- ▶ Store towing eye bolt and wheel bolt wrench in cargo compartment (▷ page 430).

Installing cover

- ▶ Fit cover and snap into place.

Practical hints

Towing the vehicle

Stranded vehicle

Freeing a stranded vehicle, on which the wheels are dug into sand or mud, should be done with the greatest of care, especially if the vehicle is heavily loaded.

Avoid pulling the vehicle jerkily or diagonally, since it could result in damage to the chassis alignment.

Never try to free a vehicle that is still coupled to a trailer.

If possible, a vehicle should be pulled backward in its own previously made tracks.

▼ Fuses

The electrical fuses in your vehicle serve to stop the supply of electricity to a device that is malfunctioning. This helps to prevent damage to the other vehicle electronics. If a fuse is blown, the components and systems secured by this fuse will stop operating.

The following aids are available to help you change fuses (▷ page 478):

- Fuse chart
- Spare fuses
- Fuse extractor

Warning!



Only use fuses approved for Mercedes-Benz with the specified amperage for the system in question. Never attempt to repair or bridge a blown fuse. Otherwise, a short circuit could result and cause a fire.



Only install fuses that have been tested and approved by Mercedes-Benz and that have the specified amperage rating. Otherwise, electrical parts or systems could be damaged.

Never attempt to repair or bridge a blown fuse. Have the cause determined and remedied by an authorized Mercedes-Benz Light Truck Center.

The electrical fuses are located in different fuse boxes:

- Main fuse box in engine compartment (▷ page 478)
- Fuse box in cargo compartment (▷ page 479)
- Fuse box in passenger compartment (▷ page 479)



Keep the fuse boxes free by contamination and wetness. Otherwise, electrical parts or systems could be damaged.

Practical hints

Fuses

Aids for changing fuses

Fuse chart

A chart explaining fuse allocation and fuse amperages can be found near the vehicle tool kit in the cargo compartment (▷ page 431).

Spare fuses

Spare fuses are found near the vehicle tool kit in the cargo compartment (▷ page 431).

Fuse extractor

The fuse extractor is found near the vehicle tool kit in the cargo compartment (▷ page 431).

Main fuse box

The main fuse box is located in the engine compartment on the passenger side.



When closing the main fuse box, make sure to fit cover ② on the fuse box properly and engage clamp ①.



ML 350

- ① Clamp
- ② Main fuse box cover



ML 500

- ① Clamp
- ② Main fuse box cover

Removing/installing main fuse box cover

- ▶ Open the hood (▷ page 326).
- ▶ Pull clamp ① in direction of arrow.
- ▶ Lift fuse box cover ② up.
- ▶ Install main fuse box cover in reverse order.

Practical hints

Fuses

Fuse box in cargo compartment

The fuse box is located on the passenger-side in the cargo compartment behind the cover.



- ① Lock
- ② Cover

Removing/installing cover

- ▶ Open the tailgate.
- ▶ Turn both locks ① 90°, e.g. with a coin or a screwdriver.
- ▶ Remove cover ②.
- ▶ Install cover ② in reverse order.

Fuse box in passenger compartment

The fuse box is located in the dashboard on the front passenger side.



- ① Cover



Do not use sharp objects such as a screwdriver to open the fuse box cover ① in the dashboard, as this could damage it.

Opening

- ▶ Open the passenger door.
- ▶ Open the glove box (> page 270).
- ▶ Insert flat, blunt object as a lever into the edge of the cover ① at the position indicated by the arrow.
- ▶ Loosen cover ① from dashboard using lever.
- ▶ Using your hands, pull cover ① out and remove.

Closing

- ▶ Hook cover ① into the opening at the front.
- ▶ Press cover ① back on until it engages.





Technical data

Parts service

Warranty coverage

Identification labels

Layout of poly-V-belt drive

Engine

Rims and tires

Electrical system

Main Dimensions

Weights

Fuels, coolants, lubricants, etc.

Technical data

Parts service

The “Technical data” section provides the necessary technical data for your vehicle.

All authorized Mercedes-Benz Centers maintain a stock of genuine Mercedes-Benz parts required for maintenance and repair work. In addition, strategically located parts distribution centers provide quick and reliable parts service.

More than 300 000 different parts for Mercedes-Benz models are available.

Genuine Mercedes-Benz parts are subjected to stringent quality inspections. Each part has been specifically developed, manufactured or selected for and adapted to Mercedes-Benz vehicles.

Therefore, genuine Mercedes-Benz parts should be installed.



The use of non-genuine Mercedes-Benz parts and accessories not authorized by Mercedes-Benz could damage the vehicle, which is not covered by the Mercedes-Benz Limited Warranty, or could compromise the vehicle's durability or safety.

▼ **Warranty coverage**

Your vehicle is covered under the terms of the warranties printed in the Service and Warranty Information booklet. Your authorized Mercedes-Benz Light Truck Center will exchange or repair any defective parts originally installed on the vehicle in accordance with the terms of the following warranties:

- New Vehicle Limited Warranty
- Emission System Warranty
- Emission Performance Warranty
- California, Maine, Massachusetts, and Vermont Emission Control Systems Warranty

Replacement parts and accessories are covered by the Mercedes-Benz Parts and Accessories warranties, copies of which are available at any authorized Mercedes-Benz Light Truck Center.

Loss of Service and Warranty Information Booklet

Should you lose your Service and Warranty Information booklet, have an authorized Mercedes-Benz Light Truck Center arrange for a replacement. It will be mailed to you.

Technical data

Identification labels



① Certification label (on driver's B pillar)



Example certification label ML 500

- ② Paintwork code
- ③ Vehicle identification number



Data shown on certification label example is for illustration purpose only. This data are specific to each vehicle and may vary from data shown in the illustration below. Refer to certification label on vehicle for actual data specific to your vehicle.

The vehicle identification number (VIN) is also embossed on the cross-bar underneath the right rear seat.

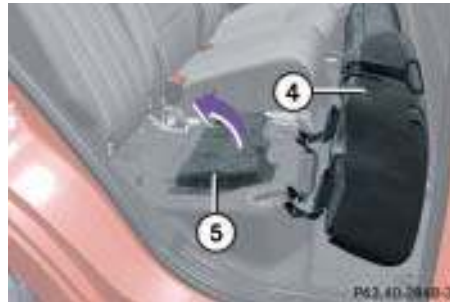

- ④ Seat cushion
- ⑤ Floor cover

- ▶ Fold the seat cushion ④ forward (▷ page 261).
- ▶ Fold floor cover ⑤ in direction of the arrow.

The VIN is now visible.



- ⑥ Emission control information label, includes both federal and California certification exhaust emission standards
- ⑦ Engine number
- ⑧ Vacuum line routing diagram label
- ⑨ VIN, visible (lower edge of windshield)

▼ Layout of poly-V-belt drive

ML 350

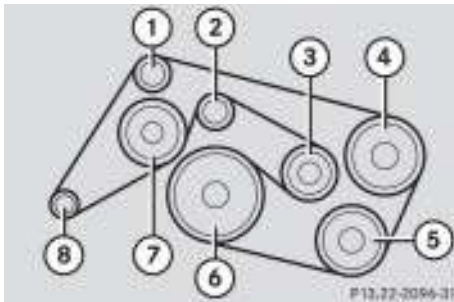

- ① Idler pulley
- ② Idler pulley
- ③ Automatic belt tensioner
- ④ Power steering pump
- ⑤ Air conditioning compressor
- ⑥ Crankshaft
- ⑦ Coolant pump
- ⑧ Generator (alternator)

ML 500

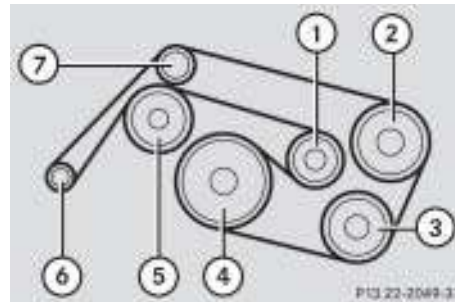

- ① Automatic belt tensioner
- ② Power steering pump
- ③ Air conditioning compressor
- ④ Crankshaft
- ⑤ Coolant pump
- ⑥ Generator (alternator)
- ⑦ Idler pulley

Technical data

Engine

Model	ML 350 (164.186 ¹)	ML 500 (164.175 ¹)
Engine	272	113
Mode of operation	4-stroke engine, gasoline injection	4-stroke engine, gasoline injection
No. of cylinders	6	8
Bore	3.66 in (92.90 mm)	3.81 in (97.00 mm)
Stroke	3.38 in (86.00 mm)	3.31 in (84.00 mm)
Total piston displacement	213 cu in (3498 cm ³)	303 cu in (4966 cm ³)
Compression ratio	10.7:1	10:1
Output acc. to SAE J 1349	268 hp/6000 rpm ² (200 kW/6000 rpm)	302 hp/5600 rpm ² (225 kW/5600 rpm)
Maximum torque acc. to SAE J 1349	258 lb-ft/2400-5000 rpm (350 Nm/2400-5000 rpm)	339 lb-ft/2700-4750 rpm (460 Nm/2700-4750 rpm)
Maximum engine speed	6500 rpm	6300 rpm
Firing order	1-4-3-6-2-5	1-5-4-2-6-3-7-8
Poly-V-belt	2404 mm	2370 mm

¹ The quoted data apply only to the standard vehicle. See an authorized Mercedes-Benz Light Truck Center for the corresponding data of all special bodies and special equipment.

² Premium fuel required. Performance may vary with fuel octane rating.

Technical data

Rims and tires

▼ Rims and tires



Only use tires which have been specifically developed for your vehicle and tested and approved by Mercedes-Benz. Tires approved by Mercedes-Benz are developed to provide best possible performance in conjunction with the driving safety systems on your vehicle such as ABS or ESP® and can be identified by finding the following on the tire's sidewall:

- MO = Mercedes-Benz Original equipment tires

Using tires other than those approved by Mercedes-Benz may result in damage that is not covered by the Mercedes-Benz Limited Warranty.



Using tires other than those approved by Mercedes-Benz can have detrimental effects, such as

- poor handling characteristics
- increased noise
- increased fuel consumption

Moreover, tires and rims not approved by Mercedes-Benz may, under load, exhibit dimensional variations and different tire deformation characteristics that could cause them to come into contact with the vehicle body or axle parts. Damage to the tires or the vehicle may be the result.





Further information on tires and rims is available at any authorized Mercedes-Benz Light Truck Center. A placard with the recommended tire inflation pressure is located on the driver's door B-pillar. Some vehicles may have supplemental tire inflation pressure information for driving at high speeds (> page 345) or for vehicle loads less than the maximum loaded vehicle condition. If such information is provided, it can be found on the placard located on the inside of the fuel filler flap. The tire inflation pressure should be checked regularly and should only be adjusted on cold tires. Follow tire manufacturer's maintenance recommendation included with vehicle.

Technical data

Rims and tires

Rims and tires

	ML 350	ML 350* ML 500	ML 350 (Sport Package*) ML 500 (Sport Package*)
Rims (light alloy)	7.5 J x 17 H2	8 J x 18 H2	8 J x 19 H2
Wheel offset	2.20 in (56 mm)	2.36 in (60 mm)	2.36 in (60 mm)
Summer tires ¹	-	-	255/50 R19 103W
All-season tires ¹	235/65 R17 104H M+S	255/55 R18 105H M+S	not available at time of printing ³
Winter tires ^{1,23}	235/65 R17 104H M+S 	255/55 R18 105H M+S 	not available at time of printing ³
All-terrain tires ^{*1,2}	-	255/55 R18 105H M+S	-

¹ Radial-ply tires

² Not available as factory equipment.

³ Data not available at time of printing; please contact an authorized Mercedes-Benz Light Truck Center.

Minispare wheel

	ML 350 ML 500
Rim	4.0B x 18 H2
Wheel offset	1.58 in (40 mm)
Tire	T 155/90-18 113M ¹

¹ Must not be used with snow chains.



Please compare the recommended tire inflation pressure for your vehicle with the tire inflation pressure on the yellow label located on the Minispare wheel rim.

If the tire inflation pressure on the yellow label on the Minispare wheel rim differs from the values given in this Operator's Manual, inflate the tire to the recommended tire inflation pressure given on the yellow label on the Minispare wheel rim.



Please note that the tire inflation pressure of the Minispare tire differs from the tire inflation pressure of the road tires.

Inflate the Minispare tire to approximately 61 psi (4.2 bar).

Technical data

Electrical system

Model	ML 350	ML 500
Generator (alternator)	14 V/180 A	14 V/180 A
Starter motor	12 V/1.4 kW	12 V/1.7 kW
Battery	12 V/70 Ah	12 V/95 Ah
Spark plugs	NGK PLKR 6A	NGK PFR 5R-11
Electrode gap	0.031 in (0.8 mm)	0.039 in (1.0 mm)
Tightening torque	15 - 22 lb-ft (20 - 30 Nm)	15 - 22 lb-ft (20 - 30 Nm)

▼ Main Dimensions

Model	ML 350, ML 500
Overall vehicle length	188.5 in (4788 mm)
Vehicle width (exterior rear view mirrors folded out)	83.7 in (2127 mm)
Vehicle width (exterior rear view mirrors folded in)	76.0 in (1930 mm)
Overall vehicle height (vehicle with steel suspension)	71.5 in (1815 mm)
Overall vehicle height, depending on set vehicle level (vehicle with air suspension package*)	69.8 in-73.0 in (1774 mm-1854 mm)
Wheelbase	114.8 in (2915 mm)
Track, front	64.0 in (1627 mm)
Track, rear	64.1 in (1629 mm)
Ground clearance (vehicle with steel suspension)	8.3 in (210 mm)
Ground clearance, depending on set vehicle level (vehicle with air suspension package*)	7.1 in-10.3 in (181 mm-261 mm)
Turning radius	39 ft (11.6 m)

Technical data

Weights

Roof load max. 220 lb (100 kg)

Technical data

Fuels, coolants, lubricants, etc.

▼ Fuels, coolants, lubricants, etc.

Capacities

Vehicle components and their respective lubricants must match.

Therefore only use products tested and approved by Mercedes-Benz.

Please refer to the Factory Approved Service Products pamphlet, or inquire at your Mercedes-Benz Light Truck Center.

	Model	Capacity	Fuels, coolants, lubricants, etc.
Engine with oil filter	ML 350	8.5 US qt (8.0 l)	Approved engine oils
	ML 500	9.1 US qt (8.5 l)	Approved engine oils
Automatic transmission		9.6 US qt (9.0 l)	MB Automatic Transmission Fluid
Transfer case single speed		0.5 US qt (0.5 l)	MB Automatic Transmission Fluid
Front axle		1.2 US qt (1.1 l)	Hypoid gear oil
Rear axle		1.2 US qt (1.1 l)	Hypoid gear oil
Power steering		approx. 1.3 US qt (1.2 l)	MB Power Steering Fluid
Front wheel hubs		approx. 1.5 oz (43 g) each	High temperature roller bearing grease

Technical data

Fuels, coolants, lubricants, etc.

	Model	Capacity	Fuels, coolants, lubricants, etc.
Cooling system	ML 350	approx. 10.2 US qt (9.5 l)	MB Anticorrosion/Antifreeze
	ML 500	approx. 10.7 US qt (10.0 l)	MB Anticorrosion/Antifreeze
Fuel Tank including a reserve of	ML 350, ML 500	25.0 US gal (95.0 l) approx. 3.5 US gal (13.0 l)	Premium unleaded gasoline: Minimum Posted Octane 91 (Avg. of 96 RON/86 MON)
Air conditioning system			R-134a refrigerant and special PAG lubricant oil (never R-12)
Windshield washer and headlamp cleaning* system		8.1 US qt (7.7 l)	MB Windshield Washer Concentrate ¹

¹ Use MB Windshield Washer Concentrate "S" and water for temperatures above freezing or MB Windshield Washer Concentrate "S" and commercially available premixed windshield washer solvent/antifreeze for temperatures below freezing. Follow suggested mixing ratios (▷ page 500).

Technical data

Fuels, coolants, lubricants, etc.

Engine oils

Engine oils are specifically tested for their suitability in our engines and durability for our service intervals. Therefore, only use approved engine oils and oil filters required for vehicles with Maintenance System (U.S. vehicles) or FSS (Canada vehicles). For a listing of approved engine oils and oil filters, refer to the Factory Approved Service Products pamphlet, or contact an authorized Mercedes-Benz Light Truck Center.

Using engine oils and oil filters of specification other than those expressly required for the Maintenance System (U.S. vehicles) or FSS (Canada vehicles), or changing of oil and oil filter at change intervals longer than those called for by the Maintenance System (U.S. vehicles) or FSS (Canada vehicles) will result in engine damage not covered by the Mercedes-Benz Limited Warranty.

Please follow Maintenance System (U.S. vehicles) or FSS (Canada vehicles) recommendations for scheduled oil changes. Failure to do so could result in engine damage not covered by the Mercedes-Benz Limited Warranty.

Engine oil additives

Do not blend oil additives with engine oil. They may damage the engine.

Damage or malfunctions resulting from blending oil additives are not covered by the Mercedes-Benz Limited Warranty.

Air conditioning refrigerant

R-134a (HFC) refrigerant and special PAG lubricating oil are used in the air conditioning system.

Never use R-12 (CFC) or mineral-based lubricating oil. Otherwise damage to the system will occur.

Brake fluid

During vehicle operation, the boiling point of the brake fluid is continuously reduced through the absorption of moisture from the atmosphere.

Warning!



Under extremely strenuous operating conditions, this moisture content can lead to the formation of bubbles in the system, thus reducing the system's efficiency. Therefore, the brake fluid must be replaced every two years, preferably in the spring.

Only brake fluid approved by Mercedes-Benz is recommended. Your authorized Mercedes-Benz Light Truck Center will provide you with additional information.

Technical data

Fuels, coolants, lubricants, etc.

Premium unleaded gasoline

Warning!



Gasoline is highly flammable and poisonous. It burns violently and can cause serious injury. Whenever you are around gasoline, avoid inhaling fumes and skin contact, extinguish all smoking materials. Never allow sparks, flame or smoking materials near gasoline!



To maintain the engine's durability and performance, premium unleaded gasoline must be used. If premium unleaded is not available and low octane fuel is used, follow these precautions:

- Have the fuel tank only partially filled with unleaded regular and fill up with premium unleaded as soon as possible.
- Avoid full throttle driving and abrupt acceleration.
- Do not exceed an engine speed of 3000 rpm if the vehicle is loaded with a light load such as two persons and no luggage.
- Do not exceed $\frac{2}{3}$ of maximum accelerator pedal position if the vehicle is fully loaded or operating in mountainous terrain.

Fuel requirements

Only use premium unleaded fuel.

- The octane number (posted at the pump) must be 91 min. It is an average of both the Research (R) octane number and the Motor (M) octane number: $(R+M)/2$. This is also known as the ANTI-KNOCK INDEX.

Unleaded gasoline containing oxygenates such as ethanol, IPA, IBA and TBA can be used provided the ratio of any one of these oxygenates to gasoline does not exceed 10%; MTBE must not exceed 15%.

The ratio of methanol to gasoline must not exceed 3% plus additional cosolvents.

Using mixtures of ethanol and methanol is not allowed. Gasohol, which contains 10% ethanol and 90% unleaded gasoline, can be used.

These blends must also meet all other fuel requirements, such as resistance to spark knock, boiling range, vapor pressure, etc.

Technical data

Fuels, coolants, lubricants, etc.

Gasoline additives

A major concern among engine manufacturers is carbon build-up caused by gasoline. Mercedes-Benz recommends only the use of quality gasoline containing additives that prevent the build-up of carbon deposits.

After an extended period of using fuels without such additives carbon deposits can build up, especially on the intake valves and in the combustion area, leading to engine performance problems such as:

- Warm-up hesitation
- Unstable idle
- Knocking/pinging
- Misfire
- Power loss

In areas where carbon deposits may be encountered due to lack of availability of gasolines which contain these additives, Mercedes-Benz recommends the use of additives approved by us for use on Mercedes-Benz vehicles. Refer to Factory Approved Service Products pamphlet for a listing of approved product(s). Follow directions on product label.

Do not blend other fuel additives with fuel. This only results in unnecessary costs and may be harmful to the engine operation.

Damage or malfunction resulting from poor fuel quality or from blending additional fuel additives other than those tested and approved by us for use on Mercedes-Benz vehicles listed in the Factory Approved Service Products pamphlet are not covered by the Mercedes-Benz Limited Warranty.

Coolants

The engine coolant is a mixture of water and anticorrosion/antifreeze, which provides:

- Corrosion protection
- Freeze protection
- Boiling protection (by increasing the boiling point)

The cooling system was filled at the factory with a coolant providing freeze protection to approximately -35°F (-37°C) and corrosion protection.

If the antifreeze mixture is effective to -22°F (-30°C), the boiling point of the coolant in the pressurized cooling system is reached at approximately 266°F (130°C).

The coolant solution must be used year round to provide the necessary corrosion protection and increase boil-over protection. Refer to Maintenance Booklet for replacement interval.

Technical data

Fuels, coolants, lubricants, etc.

Coolant system design and coolant used determine the replacement interval. The replacement interval published in the Maintenance booklet is only applicable if MB 325.0 anticorrosion/antifreeze solution or other Mercedes-Benz approved products of equal specification (see Factory Approved Service Products pamphlet) are used to renew the coolant concentration or bring it back up to the proper level.

To provide important corrosion protection, the solution must be at least 45% anticorrosion/antifreeze (equivalent to freeze protection to approx. - 22°F [-30°C]). If you use a solution that is more than 55% anticorrosion/antifreeze (freeze protection to approx. - 49°F [-45°C]), the engine temperature will increase due to the lower heat transfer capability of the solution. Therefore, do not use more than this amount of anticorrosion/antifreeze.

If the coolant level is low, water and MB 325.0 anticorrosion/antifreeze should be used to bring it up to the proper level (have cooling system checked for signs of leakage). Please make sure the mixture is in accordance with label instructions.

The water in the cooling system must meet minimum requirements, which are usually satisfied by normal drinking water. If you are not sure about the water quality, consult an authorized Mercedes-Benz Light Truck Center.

Technical data

Fuels, coolants, lubricants, etc.

Anticorrosion/antifreeze

Your vehicle contains a number of aluminum parts. The use of aluminum components in motor vehicle engines necessitates that anticorrosion/antifreeze coolant used in such engines be specifically formulated to protect the

aluminum parts. (Failure to use such anticorrosion/antifreeze coolant will result in a significantly shortened service life.)

Therefore, the following product is strongly recommended for use in your vehicle: Mercedes-Benz 325.0 anticorrosion/antifreeze agent.

Before the start of the winter season (or once a year in hot southern regions), you should have the anticorrosion/antifreeze concentration checked. The coolant is also regularly checked each time you bring your vehicle to an authorized Mercedes-Benz Light Truck Center for service.

Anticorrosion/antifreeze quantity

Model	Approx. freeze protection	
	- 35°F (- 37°C)	- 49°F (- 45°C)
ML 350	5.1 US qt (4.75 l)	5.6 US qt (5.23 l)
ML 500	5.4 US qt (5.0 l)	5.9 US qt (5.5 l)

Technical data

Fuels, coolants, lubricants, etc.

Windshield washer and headlamp cleaning* system

Both the windshield washer and headlamp cleaning* system are supplied from the windshield washer fluid reservoir.

The windshield and headlamp washer fluid reservoir has a capacity of approx. 8.1 US qt (7.7 l).

- ▶ Refill the reservoir with MB Windshield Washer Concentrate “S” and water (or concentrate and commercially available premixed windshield washer solvent/antifreeze, depending on ambient temperatures).

Warning!



Washer solvent/antifreeze is highly flammable. Do not spill washer solvent/antifreeze on hot engine parts, because it may ignite and burn. You could be seriously burned.

Windshield and headlamp washer fluid mixing ratio

For temperatures above freezing point, use MB Windshield Washer Concentrate “S” and water:

- 1 part “S” to 100 parts water
(1.34 fl oz [40 ml] “S” to 1 gallon [4.0 l] water)

For temperatures below freezing point, use MB Windshield Washer Concentrate “S” and commercially available premixed windshield washer solvent/antifreeze:

- 1 part “S” to 100 parts solvent
(1.34 fl oz [40 ml] “S” to 1 gallon [4.0 l] solvent)

ABS

(Antilock Brake System)
Prevents the wheels from locking up during braking so that the vehicle can continue to be steered.

Accessory weight

(▷ page 365)

ADS*

(Adaptive Damping System*)
Automatically adapts the optimum suspension damping to prevailing driving conditions.

Air suspension*

Automatically selects the optimum suspension tuning and ride height for your vehicle. Air suspension consists of two components:

- Adaptive Damping System
- Vehicle level control

Air pressure

(▷ page 365)

Alignment bolt

Metal pin with thread. The centering pin is an aid used when changing a tire to align the wheel with the wheel hub.

Aspect ratio

(▷ page 365)

Bar

(▷ page 365)

BAS

(Brake Assist System)
System for potentially reducing braking distances in emergency braking situations. The system is activated when it senses an emergency based on how fast the brake is applied.

Bead

(▷ page 365)

Bi-Xenon headlamps*

Headlamps which use an electric arc as the light source and produce a more intense light than filament headlamps. Bi-Xenon headlamps produce low beam and high beam.

CAC

(Customer Assistance Center)
Mercedes-Benz customer service center, which can help you with any questions about your vehicle and provide assistance in the event of a breakdown.

CAN system

(Controller Area Network)
Data bus network serving to control vehicle functions such as door locking or windshield wiping.

Cockpit

All instruments, switches, buttons and indicator/warning lamps in the passenger compartment needed for vehicle operation and monitoring.

Cold tire inflation pressure

(▷ page 365)

Technical terms

Control system

The control system is used to call up vehicle information and to change component settings. Information and messages appear in the multifunction display. The driver uses the buttons on the multifunction steering wheel to navigate through the system and to adjust settings.

Cruise control

Driving convenience system for automatically maintaining the vehicle speed set by the driver.

Curb weight

(▷ page 365)

DOT

(Department of Transportation)
(▷ page 365)

DSR

(Downhill Speed Regulation)
Driving convenience system for automatically maintaining the vehicle speed on downhill driving.

Engine number

The number set by the manufacturer and placed on the cylinder block to uniquely identify each engine produced.

Engine oil viscosity

Measurement for the inner friction (viscosity) of the oil at different temperatures. The higher the temperature an oil can tolerate without becoming thin, or the lower the temperature it can tolerate without becoming viscous, the better the viscosity.

ESP®

(Electronic Stability Program®)
Improves vehicle handling and directional stability.

ETD

(Emergency Tensioning Device)
Device which deploys in certain frontal and rear collisions exceeding the system's threshold to tighten the seat belts.
->SRS

FSS PLUS (Canada vehicles)

(Flexible Service System PLUS)
Maintenance service indicator in the multifunction display that informs the driver when the next vehicle maintenance service is due. FSS evaluates engine temperature, oil level, vehicle speed, engine speed, distance driven and the time elapsed since your last maintenance service, and calls for the next maintenance service accordingly.

GAWR

(Gross Axle Weight Rating)
The GAWR is the maximum permissible axle weight. The gross vehicle weight on each axle must never exceed the GAWR for the front and rear axle indicated on the certification label located on the driver's door pillar.

Gear range

Number of gears which are available to the automatic transmission for shifting. The automatic gear shifting process can be adapted to specific operating conditions using the gear selector lever.

GPS

(Global Positioning System)
Satellite-based system for relaying geographic location information to and from vehicles equipped with special receivers. Employs CD or DVD digital maps for navigation.

GVW

(Gross Vehicle Weight)
The GVW comprises the weight of the vehicle including fuel, tools, spare wheel, installed accessories, passengers and cargo. The GVW must never exceed the GVWR, indicated on the certification label located on the driver's door pillar.

GVWR

(Gross Vehicle Weight Rating)
This is the maximum permissible vehicle weight. It is indicated on certification label located on the driver's door pillar.

Instrument cluster

The displays and indicator/warning lamps in the driver's field of vision, including the tachometer, speedometer, engine temperature and fuel gauge.

KEYLESS-GO*

System for entering and operating the vehicle without the use of a SmartKey.

Kickdown

Depressing the accelerator past the point of resistance shifts the transmission down to the lowest possible gear. This very quickly accelerates the vehicle and should not be used for normal acceleration needs.

Kilopascal (kPa)

(▷ page 366)

Line of fall

The direct line that an object moves downhill when influenced by the force of gravity alone.

Locking knob

Knob on the door which indicates whether the door is locked or unlocked. Pushing the locking knob down on an individual door from inside will lock that door.

Maintenance System (U.S. vehicles)

Maintenance service indicator in the multifunction display that informs the driver when the next vehicle maintenance service is due. The Maintenance System in your vehicle tracks distance driven and the time elapsed since your last maintenance service, and calls for the next maintenance service accordingly.

Maximum load rating

(▷ page 366)

Maximum loaded vehicle weight

(▷ page 366)

Technical terms

Maximum tire inflation pressure

(▷ page 366)

Modular COMAND System

Information and operating center for vehicle sound and communications systems, including the radio and the radio and navigation system, as well as for other optional equipment (CD changer, telephone, etc.).

Memory function*

Used to store three individual seat, steering wheel and exterior mirror positions.

MON

(Motor Octane Number)

The Motor Octane Number for gasoline as determined by a standardized method. It is an indication of a gasoline's ability to resist undesired detonation (knocking). The average of both the MON (Motor Octane Number) and →RON (Research Octane Number) is posted at the pump, also known as ANTI-KNOCK INDEX.

Multifunction display

The display field in the instrument cluster used to present information provided by the control system.

Multifunction steering wheel

Steering wheel with buttons for operating the control system.

Normal occupant weight

(▷ page 366)

OCS

(Occupant Classification System)

The system automatically turns the front passenger front air bag on or off based on the classified occupant size category determined by weight sensor readings from the seat.

Overspeed range

Engine speeds within the red marking on the tachometer dial. Avoid this engine speed range, as it may result in serious engine damage that is not covered by the Mercedes-Benz Limited Warranty.

Parktronic (Parking assist)*

System which uses visual and acoustic signals to assist the driver during parking maneuvers.

Poly-V-belt drive

Drives engine-components (alternator, AC compressor, etc.) from the engine.

Power train

Collective term designating all components used to generate and transmit motive power to the drive axles, including

- Engine
- Clutch/torque converter
- Transmission
- Transfer case
- Drive shaft
- Differential
- Axle shafts/axles

Production options weight

(▷ page 366)

PSI

(Pounds per square inch) (▷ page 366)

Recommended tire inflation pressure

(▷ page 366)

REST

(Residual engine heat utilization)
Feature that uses the engine heat stored in the coolant to heat the vehicle interior for a short time after the engine has been turned off.

Restraint systems

Seat belts, belt tensioner, air bags and child restraints, lower anchors and tethers for children (LATCH). As independent systems, their protective functions complement one another.

Rim

(▷ page 367)

RON

(Research Octane Number)
The Research Octane Number for gasoline as determined by a standardized method. It is an indication of a gasoline's ability to resist undesired detonation (knocking). The average of both the →MON (Motor Octane Number) and RON (Research Octane Number) is posted at the pump, also known as ANTI-KNOCK INDEX.

Sidewall

(▷ page 367)

SRS

(Supplemental Restraint System)
Air bags, air bag control unit (with crash sensor), emergency tensioning device. Though independent systems, they are closely interfaced to provide effective occupant protection.

Tele Aid* System

(Telematic Alarm Identification on Demand)
The Tele Aid system consists of three types of response: automatic and manual emergency, Roadside Assistance and information. Tele Aid is initially activated by completing a subscriber agreement and placing an acquaintance call.
The Tele Aid system is operational provided that the vehicle's battery is charged, properly connected, not damaged and cellular and GPS coverage is available.

Telematics*

A combination of the terms "telecommunications" and "informatics".

Tightening torque

Force times lever arm (e.g. a lug wrench) with which threaded fasteners such as wheel bolts are tightened.

Technical terms

TIN

(Tire Identification Number)
(▷ page 367)

Tire load rating

(▷ page 367)

Tire ply composition and material used

(▷ page 367)

Tire speed rating

Part of tire designation; indicates the speed range for which a tire is approved.

Traction

Force exerted by the vehicle on the road via the tires.

Transfer case

Speed of rotation/torque converter that works together with the ->automatic transmission.

Tread

(▷ page 367)

Treadwear indicators

(▷ page 367)

TWR

(Tongue Weight Rating)
The TWR is the maximum permissible weight on the trailer tongue.

Uniform Tire Quality Grading Standards

(▷ page 367)

Vehicle capacity weight

(▷ page 367)

Vehicle level control*

The ground clearance of the vehicle is automatically controlled according to a selected setting and speed. The driver can set the ground clearance manually for example on very rough roads.

Vehicle maximum load on the tire

(▷ page 368)

VIN

(Vehicle Identification Number)
The number set by the manufacturer and placed on the body to uniquely identify each vehicle produced.

- A**
- ABS 93, 501
 - ABS control 93
 - Malfunction indicator lamp 382
 - Messages in display 397
 - Off-road - ABS 94
 - Warning lamp 382
 - Accelerator position, automatic transmission 190
 - Accessory weight 365
 - Accident
 - In case of 59
 - Activating
 - Air circulation mode 226
 - Air conditioning (cooling) 211
 - Air recirculation mode 209, 224
 - Anti-theft alarm system 101
 - Central locking (control system) 172
 - Defrosting 208
 - Easy-entry/exit feature* 173
 - ESP® 98
 - Exterior headlamps 54
 - Hazard warning flasher 145
 - Headlamps 54
 - High beams 142
 - Ignition 34
 - Immobilizer 62, 100
 - Rear window defroster 201
 - Rear window wiper 58
 - Residual heat 212, 227
 - Seat heating* 134
 - Tow-away alarm 102
 - Warning indicators (Parktronic*) 256
 - Windshield wipers 55
 - Adaptive Damping
 - System (ADS)* 249, 501
 - Adding
 - Coolant 333
 - Engine oil 331
 - Additional turn signals 443
 - Adjusting 38
 - Air distribution 207, 222
 - Air volume 207, 208, 222
 - Backrest tilt 40
 - Compass zone 171
 - Exterior rear view mirror 44
 - Head restraint height 40
 - Head restraint tilt 41
 - Headlamp aim 451
 - Instrument cluster illumination 148
 - Interior rear view mirror 44
 - Mirrors 43
 - Multicontour seat* 132
 - Seat cushion depth 132
 - Seat cushion tilt 40
 - Seat fore and aft adjustment 39
 - Seat height 39
 - Seats 38
 - Steering column height 43
 - Steering wheel 41
 - Adjusting steering column 43
 - ADS* 501

Index

- Air bags 67
 - Children 68
 - Front 71
 - Passenger 71
 - Safety guidelines 70
 - Side impact 72
 - Window curtain 72
- Air conditioning
 - Turning off 211
 - Turning on 211
- Air conditioning refrigerant 495
- Air distribution
 - Adjusting 207, 222
- Air pressure 365, 501
- Air pressure see Tire inflation pressure
- Air recirculation mode 209, 223
 - Activating 209, 224
 - Deactivating 210, 225
- Air suspension package* 249
- Air suspension* 501
- Air volume
 - Adjusting 207, 208, 222
- Alarm
 - Audible 91, 102
 - Canceling 102
 - Visual 100
- Alarm system
 - Anti-theft 100
- Alignment bolt (vehicle tool kit) 501
- Anticorrosion/antifreeze 499
- Antilock brake system (ABS) 501
- Anti-theft alarm system
 - Arming 101
 - Canceling alarm 102
 - Disarming 101
- Anti-theft systems
 - Anti-theft alarm system 100
 - Immobilizer 100
 - Tow-away alarm 102
- Aquaplaning see Hydroplaning
- Armrest
 - Storage compartment in front of 272
 - Storage compartments 272
- Armrest in rear seat bench 275
- Ashtray*
 - Front center console 275
- Aspect ratio 365
- ATF (automatic transmission fluid) 332
- Attaching a trailer 316
- AUDIO menu 157
 - Selecting radio station 157
 - Selecting satellite radio* station (USA only) 157
- Audio system
 - CD mode 158
- Auto-dimming rear view mirror* 195
- Auto-dimming*
 - Rear view mirror 195
- Automatic central locking
 - Activating/deactivating (control system) 172

- Automatic climate control (3-zone)*
 - Adjusting air distribution 222
 - Adjusting air volume 222
 - Air recirculation mode 223
 - Defrosting 223
 - Rear passenger compartment 227
 - Rear window defroster 200
 - Residual heat utilization 226
 - Residual ventilation 226
 - Setting the temperature 221
- Automatic climate control*
 - 3-zone automatic climate control* 216
- Automatic climate control* (3-zone) 216
- Automatic headlamp mode 139
- Automatic lighting control
 - Deactivating 146
- Automatic locking when driving 125
- Automatic transmission 49
 - Accelerator position 190
 - Emergency operation (Limp Home Mode) 192
 - Gear ranges 187
 - Gear selector lever position 184, 185
 - Gear shifting malfunctions 192
 - Gearshift pattern for 49
 - Kickdown 190
 - Towing a trailer 191
 - Transmission fluid 332
- B**
- Backrest
 - Folding forward 261
- Backup lamps 444, 451
 - Bulbs 444
- Bar 365, 501
- BAS 95, 501
- Batteries, SmartKey
 - Check lamp 109, 115
- Batteries, vehicle
 - Messages in display 398, 407
- Battery
 - Key batteries 440
 - Replacing key batteries 440
- Battery discharged
 - Jump starting 470
- Battery, vehicle 462
 - Charging 469
 - Dis-/reconnecting 464
 - Removing/installing 464
- Bead 365, 501
- Belt reel 267
- Bi-Xenon headlamps* 501
- Block heater (Canada only) 370
- Blocking
 - Rear door window operation 89
- Brake assist system (BAS) 501
- Brake fluid 495
 - Message in display 409
- Brake lamp bulbs 444

Index

Brake pads
 Message in display 408
 Brakes 300
 Warning lamp 383
 Break-in period 298
 Bulbs, replacing 443
 Additional turn signals 443
 Backup lamps 444
 Brake lamps 444
 Fog lamps 443
 Front fog lamp 449
 Front lamps 443
 High beam 443
 License plate lamps 444, 451
 Low beam 443
 Parking, standing lamp 443
 Rear fog lamps 450
 Rear side marker lamp bulbs 450
 Side marker lamp 443
 Side marker lamps 444
 Turn signal lamps 443, 444

C
 CAC (Customer Assistance Center) 501
 Calibrating
 Compass 171
 California
 Important notice 11
 Call priority
 Tele Aid* 287
 Calling up
 Range (distance to empty) 178
 Service indicator 372
 CAN system 501
 Capacities
 Fuels, coolants, lubricants, etc. 493
 Cargo compartment
 Fuse box in 479
 Interior lighting 145
 Lamp 147
 Tie-down rings 260
 Cargo compartment cover* 265
 Closing 265
 Installing 265
 Opening 265
 Removing 265
 Cargo tie-down rings 260

Carpet
 Cleaning 379
 Catalytic converter 320
 CD player
 Operating 158
 Center console 27
 Lower part 28
 PASS AIR BAG OFF indicator
 lamp 393
 Upper part 27
 Central locking
 Automatic 125
 Switch 126
 Switching on/off
 (control system) 172
 Unlocking from inside 126
 Central locking switch 126
 Certification label 484
 Changing
 SmartKey setting 173
 Charging
 Vehicle battery 469
 CHECK ENGINE malfunction
 indicator lamp 385, 386

- Checking
 - Coolant level 332
 - Engine oil with the control system (ML 500 only) 328
 - Engine oil with the oil dipstick (ML 350 only) 330
 - Oil level 327
 - Tire inflate pressure 325
 - Vehicle lighting 325
- Checking tire pressure electronically with the Advanced Tire Pressure Monitoring System* (Advanced TPMS*) 351
- Checking weights
 - Trailer and vehicle 315
- Checklist
 - Off-road driving 307
 - Returning from off-road driving 313
- Child safety 78
 - Air bags 68
 - Infant and child restraint systems 73, 78
 - LATCH type child seat mounts 88
- Child safety switch see Blocking of rear door window operation
- Cigarette lighter*
 - Front center console 275
- Cleaning
 - Carpet 379
 - Cup holder 379
 - Gear selector lever 379
 - Hard plastic trim items 379
 - Headlamps 194
 - Headliner 379
 - Instrument cluster 379
 - Leather upholstery* 380
 - Light alloy wheels 379
 - MB Tex upholstery 380
 - Plastic and rubber parts 380
 - Seat belts 379
 - Steering wheel 379
 - Windows 378
 - Windshield 56
 - Wiper blades 378
- Cleaning and care of the vehicle 374
- Cleaning tires 337
- Climate control 202
 - Adjusting 207
 - Adjusting air volume 208
 - deactivating 206
 - Defrosting 208
 - Rear passenger compartment 213
 - Rear window defroster 200
 - Setting the temperature 207
- Clock 165
- Closing
 - Glove box 270
 - Hood 327
 - Power tilt/sliding sunroof* 439
 - Side windows 231
 - Side windows with KEYLESS-GO* 234
 - Tailgate 120
 - Vehicle with KEYLESS-GO* 123, 124
 - Tilt/sliding sunroof* 235
 - Tilt/sliding sunroof* with KEYLESS-GO* 234
 - Windows 230

Index

- Closing the tailgate 123, 124
- Closing the tailgate from
 - the inside electrically* 120
- Closing the tailgate from the
 - outside (vehicles without KEYLESS-GO*) 121
- Closing tilt/sliding sunroof*
 - In an emergency 439
- Cockpit 22, 501
- Cold tire inflation pressure 365
- Combination switch 142
 - High beam 54
 - Turn signals 54
 - Windshield wipers 55
- Compass 295
 - Adjusting compass zone 171
 - Calibrating 171
 - Zone map North America 295
 - Zone map South America 295
- Control and operation
 - of radio transmitters 320
- Control system 502
 - AUDIO menu 157
 - Convenience submenu 173
 - Display digital speedometer 156
 - Functions 154
 - Instrument cluster submenu 164, 165
 - Lighting submenu 167
 - Menus 153, 154
 - Message memory menu 159
 - Selecting radio system 157
 - Selecting satellite radio* station (USA only) 157
 - Settings menu 161
 - Standard display menu 156
 - Submenus 152, 154
 - TEL* menu 178
 - Trip computer menu 177
 - Vehicle submenu 171
- Convenience submenu 173
 - Activating easy-entry/exit feature* 173
 - Setting parking position* for exterior rear view mirror 174
- Coolant 332, 497
 - Adding 333
 - Anticorrosion/antifreeze quantity 498
 - Checking level 332
 - Messages in display 410, 412
 - Temperature 322
- Coolant level
 - Checking 332
- Corner-illuminating front fog lamps* 143
 - Switching off 144
 - Switching on 143, 144
- Crossing obstacles 311
- Cruise control 238, 502
 - Canceling 240
 - Driving downhill 240
 - Driving uphill 240
 - Message in display 398
 - Setting current speed 239
 - Setting speeds 243
- Cruise control lever 238, 246

- Cup holder 274
 - Cleaning 379
 - In front seat armrest 274
 - In rear center console 274
 - Reinstalling 275
 - Removing 275
- Curb weight 365
- Customer Assistance Center (CAC) 501
- D**
- Daytime running lamp mode 140
 - Setting 167, 168
- Deactivating
 - Air conditioning 211
 - Air conditioning (cooling) 226
 - Air recirculation mode 210, 225
 - Alarm 101
 - Anti-theft alarm system 101
 - Automatic climate control* (3-zone) 220
 - Central locking (control system) 172
 - Climate control 206
 - climate control system 206
 - Cruise control 240
- Defrost 209, 223
- Engine 62
- ESP® 97
- Hazard warning flasher 145
- Headlamps 62
- Immobilizer 100
- Interior lighting delayed switch-off 170
- Rear passenger compartment ventilation and climate control 228
- Rear window defroster 201
- Rear window wiper 58
- Residual heat 212, 227
- Seat heating* 134
- Tow-away alarm 102
- Deep water see Standing water
- Defogging
 - Windshield 208, 222
- Defrosting 208, 223
- Delayed switch-off
 - Interior lighting 170
- Department of Transportation see DOT
- Dialing
 - A number (telephone*) 180
- Difficulties
 - While driving see Problems while driving
- Digital speedometer 156
- Direction of rotation (tires) 338
- Discharged battery
 - Jump starting 470
- Disconnecting
 - Vehicle battery 464
- Display
 - Selecting 165
- Displays
 - Digital speedometer 156
 - Maintenance service indicator 371
 - Messages 329
 - Selecting 165
 - Showing messages 160
- Distance to empty (range)
 - Calling up 177
- Door control panel 30
- Door entry lamps 147
- Door handle 30
- Door unlock
 - With Tele Aid* 288

Index

- Doors
 - Message in display 413
 - Opening from inside vehicle 117
 - Opening from outside 108
 - DOT 365
 - Downhill driving
 - Cruise control 240
 - Downhill Speed Regulation (DSR) 243
 - Switching off 245
 - Switching on 245
 - Drink holder see Cup holder
 - Drinking and driving 299
 - Drive sensibly-save fuel 299
 - Driving 46, 52
 - Abroad 319
 - In winter 304
 - Problems 58
 - Safety systems 93
 - Through standing water 305
 - Driving abroad 319
 - Driving instructions
 - Towing a trailer 317
 - Driving off 301
 - Driving safety systems
 - 4-ETS 98
 - ABS 93
 - BAS 95
 - ESP® 95
 - Driving systems 238
 - Cruise control 238
 - Driving safety systems 93
 - EBP 98
 - Parktronic* 254
 - Driving through water 310
 - Driving tips 190
 - Accelerator position 190
 - Kickdown 190
- E**
- Easy-entry/exit feature
 - Vehicles with memory function* 128
 - Easy-entry/exit feature*
 - Activating 173
 - EBP 98
 - Electrical connections
 - Trailer 314
 - Electrical fuses 477
 - Electrical system
 - Technical data 490
 - Electronic Brake Proportioning see EBP
 - Electronic Stability Program® see ESP®
 - Electronic Traction System see 4-ETS
 - Emergency
 - Unlocking and opening
 - the tailgate in an 437
 - Emergency calls
 - Initiating an emergency call 284
 - With Tele Aid* 282
 - Emergency operation
 - (Limp Home Mode) 192

- Emergency operations
 - Closing tilt/sliding sunroof* 439
 - Locking the vehicle 436
 - Opening tilt/sliding sunroof* 439
 - Remote door unlock 288
 - Unlocking the vehicle 435
- Emergency tensioning device see ETD
- Emission control 321
- Ending
 - A call (telephone*) 180
- Engine
 - Message in the display 410
 - Starting 49
 - Starting with KEYLESS-GO* 50
 - Technical data 486
 - Turning off 62
- Engine cleaning 376
- Engine compartment
 - Hood 326
 - Main fuse box 478
- Engine malfunction
 - indicator lamp 385, 410
- Engine malfunction indicator lamp (Canada only) 25
- Engine malfunction indicator lamp (USA only) 25
- Engine number 502
- Engine oil 327, 495
 - Adding 331
 - Additives 495
 - Checking level 327
 - Checking with the control system (ML 500 only) 328
 - Checking with the oil dipstick (ML 350 only) 330
 - Consumption 327
 - Display messages 414–415
 - Messages in display 329, 414–415
 - Viscosity 502
- ESP® 25, 95, 502
 - Off-road-ESP® 98
 - Switching off 97
 - Switching on 98
 - Warning lamp 387
- ETD 502
 - Safety guidelines 70
- ETD (Emergency tensioning device) 76
- Exterior mirrors
 - Folding 197
- Exterior rear view mirrors
 - Adjusting 44
 - Parking position* for 174
- F**
 - Fastening the seat belts 46
 - First aid kit 430
 - Flat tire 456
 - Lowering the vehicle 460
 - Preparing the vehicle 457
 - Spare wheel 433
 - Flexible Service System PLUS (FSS PLUS) 502
 - Floormats* 279
 - Fluid level
 - Automatic transmission 332
 - Fog lamp, rear
 - Switching on 142
 - Fog lamps
 - Replacing bulbs 443
 - Fog lamps, front
 - Messages in display 418
 - Replacing bulbs 445
 - Switching on 142
 - Folding
 - Exterior mirrors 197
 - Folding the backrest forward 261
 - 4-ETS 98
 - Off-road - 4-ETS 99

Index

Front air bags 71
Front fog lamps
 Indicator lamp 138
 Switching on 142
Front lamps
 Messages in display 418
 Replacing bulbs 443, 445
Front turn signal bulbs
 Replacing 448
Front wiper blades
 Installing 453
 Removing 453
FSS Plus
 (Flexible Service System PLUS) 502
Fuel 324
 Additives 497
 Fuel tank reserve warning lamp 388
 Gasoline additives 497
 Premium unleaded gasoline 324,
 496
 Requirements 496
Fuel additives 497

Fuel cap
 Message in display 416
Fuel consumption statistics
 After start 177
 Since last reset 177
Fuel filler flap 323
 Locking 323
 Opening 438
 Unlocking 323
Fuel requirements 496
Fuel reserve tank
 Message in display 416
Fuel tank
 Filler flap 323
Fuels, coolants, lubricants etc. 493
Functions (control system) 154
 Resetting 162
Fuse box
 In cargo compartment 479
Fuse chart 478
Fuse extractor 478
Fuses 477
 Fuse chart 478
 Main fuse box 478

G
Garage door opener 289
 Erasing in remote control 294
Gasoline additives 497
Gasoline see Fuel
GAWR 365
GAWR (Gross Axle Weight Rating) 502
Gear range 503
 Limiting 187
 Shifting into optimal 190
Gear range limit
 Canceling 190
Gear ranges
 Automatic transmission 187
Gear selector lever
 Cleaning 379
 Gearshift pattern for automatic
 transmission 182
 Message in the display 400
 Position 185
 Shifting procedure 184
Global
 Locking 108
 Unlocking 108

Global Positioning System (GPS) 503
 Glove box 270
 Closing 270
 Opening 270
 Good visibility 194
 GPS 503
 Gross Axle Weight Rating see GAWR
 Gross Trailer Weight see GTW
 Gross Vehicle Weight Rating see GVWR
 Gross Vehicle Weight see GVW
 GTW 365
 GVW 366
 GVW (Gross Vehicle Weight) 503
 GVWR 366
 GVWR
 (Gross Vehicle Weight Rating) 503

H
 Hard plastic trim items
 Cleaning 379
 Hazard warning flasher 144
 Switching off 145
 Switching on 145
 Head restraints
 Power seats 40
 Headlamp aim
 Adjusting 451
 Headlamp cleaning system* 333
 Headlamps
 Automatic control 139
 Bi-Xenon* 501
 Cleaning 377
 Cleaning system* 194, 333
 Manual mode 139
 Refilling washer fluid 334
 Switching off 62
 Switching on 54
 Washer fluid 500
 Washer system 500
 Headliner
 Cleaning 379

Heated seats* 133
 Height adjustment
 Head restraints 40
 Seat belts 48
 Steering wheel 41
 High beam 54
 High beam flasher 143
 High beam halogen headlamps
 Replacing bulbs 447
 High beam headlamps
 Messages in display 419
 Replacing bulbs 443
 Switching on 142
 Hill start assist system 191
 Hood 326
 Closing 327
 Message in display 416
 Opening 326
 Hooks
 Loading 261
 Hydroplaning 303

Index

I

- Identification labels 484
 - Certification label 484
- Ignition 34
 - Switching on 50
- Immobilizer 100
 - Activating 100
 - Deactivating 100
- Important guidelines 335
- Infant and child restraint systems 78
 - Installing 87
 - LATCH type child seat mounts 88
- Information
 - About service and warranty 10
 - Button for Tele Aid* 286
- Inside rear view mirror
 - Antiglare 195
- Installing
 - Front wiper blades 453
 - Infant and child restraint systems 87
 - Rear wiper blade 455
 - Vehicle battery 464

- Installing towing eye bolt
 - Towing the vehicle 474
- Instrument cluster 24, 148, 503
 - Cleaning 379
 - Illumination 148
 - Lamps in 388
 - Outside temperature indicator 149
 - Selecting language 164
- Instruments and controls see Cockpit
- Integrated remote control
 - Erasing memory 294
 - Operating 294
- Interior lighting 145
 - Deactivating automatic control 146
 - Delayed switch-off 170
 - Manual operation 146
- Interior rear view mirror
 - Adjusting 44
- Intermittent wiping 56

J

- Jack 431
- Jump starting 470

K

- Key, Mechanical 435
- KEYLESS-GO* 503
 - Closing
 - Tailgate 123, 124
 - Closing side windows 234
 - Closing tilt/sliding sunroof* 234
 - Loss of SmartKey with KEYLESS-GO* 116
 - Starting the engine 50
 - Turning off engine 63
 - Unlocking and opening, tailgate 115
 - Unlocking with 33
- Kickdown 190, 503
- Kilometers/miles in speedometer 164
- Kilopascal 366
- Km/h or mph in speedometer 164

L

Labels, identification 484
 Lamp bulbs, exterior 443
 Lamps, exterior
 Front 443
 Light sensor 420
 Messages in display 418, 420
 Rear 444
 Lamps, indicator and warning
 ABS 382
 Air bag Off 72
 Battery (SmartKey with
 KEYLESS-GO*) 114
 Battery (SmartKey) 108
 Brakes 383
 CHECK ENGINE 385, 386
 CHECK Engine malfunction
 indicator lamp 386
 Engine diagnostics 385, 386
 ESP® 387
 Front fog lamps 138
 Fuel reserve 388
 Rear fog lamp 138
 Seat belts 388, 389
 SRS 390

Language
 Multifunction display 164
 Setting 164
 LATCH type child seat anchors 88
 LATCH type child seat mounts 88
 Layout of poly-V-belt drive (ML 350) 485
 Layout of poly-V-belt drive (ML 500) 485
 Leather upholstery*
 Cleaning 380
 Lever
 For cruise control 238
 License plate lamps
 Messages in display 419
 Replacing bulbs 444, 451
 Light alloy wheels
 Cleaning 379
 Light sensor 420
 Lighter see cigarette lighter

Lighting 138
 Automatic headlamp mode 139
 Cargo compartment lamp 147
 Daytime running lamp mode 140
 Door entry lamps 147
 Front fog lamps 142
 High beams 142
 Instrument cluster illumination 148
 Interior 145
 Locator lighting 141
 Low beam 138
 Manual headlamp mode 139
 Night security illumination 141
 Parking lamps 138
 Rear fog lamp 142
 Settings (control system) 167
 Standing lamps 138
 Limiting the gear range 187
 Limp Home Mode 192
 Line of fall 503

Index

- Loading 259
 - Cargo compartment cover* 265
 - Cargo tie-down rings 260
 - Hooks 261
 - Instructions 259
 - Partition net* 263
 - Roof rack* 269
 - Trailer 315
 - Loading terminology 365
 - Loading the vehicle 338
 - Locator lighting 141
 - Setting 168
 - Lock buttons
 - Door handle (KEYLESS-GO*) 64
 - Locking 106
 - Automatic while driving 125
 - Centrally from inside 126
 - Fuel filler flap 323
 - Global (SmartKey with KEYLESS-GO*) 113
 - Global, SmartKey 108
 - Vehicle in an emergency 436
 - Locking knob 503
 - Locking knobs 32
 - Locking the vehicle 116
 - Loss of Service and Warranty Information Booklet 483
 - Loss of SmartKey 110
 - Loss of Smartkey with KEYLESS-GO* 116
 - Low beam bulbs
 - Replacing bulbs 446
 - Low beam headlamps
 - Replacing bulbs 443
 - Switching on 54
 - Lowering
 - Vehicle 460
- M**
- Main dimensions 491
 - Main fuse box 478
 - Maintenance 12
 - Maintenance service
 - Resetting maintenance service indicator 373
 - Term exceeded 372
 - When due 371
 - Maintenance service indicator 371
 - Resetting 373
 - Malfunction
 - Parktronic* system 258
 - Manual headlamp mode 139
 - Manual operations
 - Fuel filler flap 438
 - Interior lighting control 146
 - Locking the vehicle 436
 - Power tilt/sliding sunroof* 439
 - Unlocking the driver's door 435
 - Manual seat
 - Adjusting head restraint tilt 41

- MAXCOOL maximum cooling 223
- Maximum inflation pressure 366
- Maximum load rating 366
- Maximum loaded vehicle weight 366
- Maximum tire inflation pressure 504
- MB Tex upholstery
 - Cleaning 380
- Mechanical key 435
- Memory function* 135, 504
 - Recalling positions from memory 136
- Menus 153
 - AUDIO 157
 - In control system 153, 154
 - Message memory 159
 - Settings menu 161
 - Standard display 156
 - Submenus 152
 - TEL* 178
 - Trip computer 177
- Message
 - Displaying 160
- Message memory 159
 - Calling up 159
- Miles/kilometers in speedometer
 - Setting 164
- Minispare wheel
 - Spare wheel 433
- Mirrors
 - Activating exterior mirror parking position* 196
 - Adjusting 43
 - Auto-dimming rear view mirror* 195
 - Exterior rear view mirror 44
 - Exterior rear view mirror parking positions* 174
- Modular COMAND System 504
- Modular COMAND System see separate operating instructions
- MON 324
- MON (Motor Octane Number) 504
- Mounting
 - New wheel 459
- Mph or km/h in speedometer 164
- Multicontour seat* 132
- Multifunction display 504
 - Selecting language 164
 - Standard display 154
- Multifunction display messages
 - ABS 397
 - Batteries 398, 407
 - Brake fluid 409
 - Brake pads 408
 - Coolant 412
 - Coolant level 410
 - Cruise control 398
 - Doors 413
 - EBP (Electronic Brake Proportioning) 408
 - Engine oil 414–415
 - Fuel cap 416
 - Fuel reserve tank 416
 - Hood 416
 - Lamps 420
 - Lamps, exterior 418
 - Oil 414–415
 - Parking brake 409
 - SmartKey 417
 - SmartKey with KEYLESS-GO* 417
 - Tailgate 427
 - Tele Aid* 425, 426
 - Washer fluid 427
- Multifunction steering wheel 26, 504

Index

N

Navigation system see separate Modular
COMAND System operating instructions
Night security illumination 141
Normal occupant weight 366

O

Occupant Classification System 81
 Self-test 86
Occupant Classification System see OCS
Occupant distribution 366
Occupant safety 66
 Children and air bags 68
 Children in the vehicle 78
 Fastening the seat belt 46
 Infant and child restraint systems 78
 LATCH type child seat mounts 88
 Seat belts 46, 70
OCS 504
Off-road - 4-ETS 99
Off-road - ABS 94
Off-road - ESP® 98

Off-road driving
 Checklist 307, 313
 Crossing obstacles 311
 Driving instructions off-road
 driving 306
 Driving through water 310
 Returning 313
 Rules 307
 Special driving features 306
 Steep terrain 308
Off-road driving program 248
 Switching off 249
 Switching on 249
Oil
 Adding 331
 Consumption 327
 Dipstick 327
 Filler neck 331
 Viscosity 502
One-touch gearshifting
 Canceling gear range limit 190

Opening

Doors from the inside 117
Fuel filler flap 323
Fuel filler flap manually 438
Glove box 270
Hood 326
Power tilt/sliding sunroof* 439
Side windows 232
Tailgate 118
Tilt/sliding sunroof* 235
Tilt/Sliding sunroof* in an
 emergency 439
Windows 230
Opening the tailgate from
 the inside electrically* 118
Opening the tailgate from
 the outside 118

Operating
 CD player 158
 Garage door opener 294
 Integrated remote control 294
 Radio 157
 Radio transmitters 320
 Telephone* 178
 Vehicle outside the USA or
 Canada 13
Operating safety 17
Operator's Manual 10
Ornamental moldings 377
Outside temperature indicator 149
Overhead control panel 29
Overspeed range 504

P
Paintwork 375
Panic alarm 91
 Panic button on SmartKey 91
 Panic button on SmartKey with
 KEYLESS-GO* 91
Parcel net in front passenger
 footwell 270
Parking 301
Parking and locking 60
Parking brake 52, 61
 Engaging 61
 Message in display 409
 Releasing 52
Parking position*
 Exterior rear view mirrors 174
Parking, standing lamp
 Replacing bulbs 443
Parking/standing lamp bulb
 Replacing 448
Parktronic (Parking assist)* 504
Parktronic system*
 Cleaning system sensor 377
 Range of the sensors 255
 Sensor cover 377

Parktronic*
 Warning indicators 256
Parktronic* system
 Malfunction 258
 Switching off 257
 Switching on 257
Parktronic* system (Parking assist) 254
Partition net* 263
 Engaging 263
 Removing 264
 Tightening 264
Parts see Parts service
Parts service 482
Passenger compartment 319
Passenger safety see Occupant safety
Pedals 299
Phone book*
 Loading 180
 Quick search 180
Phone number*
 Dialing 180
 Redialing 181
Plastic and rubber parts
 Cleaning 380

Index

- Poly-V-belt drive 504
 - Layout (ML 350) 485
 - Layout (ML 500) 485
 - Positions (Memory function*)
 - Recalling from memory 136
 - Storing in memory 136
 - Potential problems associated
 - with underinflated and overinflated tires 354
 - Power assistance 299
 - Power outlets
 - 12-V sockets 277
 - Power seat
 - Adjusting backrest tilt 40
 - Adjusting head restraint height 40
 - Adjusting seat cushion tilt 40
 - Adjusting seat height 39
 - Seat fore and aft adjustment 39
 - Power tilt/sliding sunroof* 235
 - Closing 439
 - Opening 439
 - Power train 504
 - Power washer 375
 - Power windows
 - Blocking of rear door window operation 89
 - Side windows 230
 - Synchronizing 232
 - Practical hints
 - First aid kit 430
 - Fuses 477
 - Jump starting 470
 - Lamp in center console 393
 - Lamps in instrument cluster 382
 - Messages in the display 395
 - Spare wheel 433
 - Vehicle jack 431
 - Vehicle tool kit 430
 - Premium unleaded gasoline 496
 - Problems
 - While driving 58
 - With vehicle 18
 - Product information 9
 - Production options weight 366
 - PSI 366, 367
-
- Q**
 - Quick search
 - Phone book* 180
-
- R**
 - Radio
 - Selecting stations 157
 - Selecting stations (satellite*) 157
 - Radio transmitters, control and operation 320
 - Range (distance to empty)
 - Calling up 178
 - Range of the sensors
 - Parktronic* system 255
 - Rear automatic climate control 227, 228
 - Rear climate control 213
 - Rear door window
 - Blocking operation 89
 - Rear fog lamp
 - Indicator lamp 138
 - Switching on 142
 - Rear lamp bulbs
 - Replacing 450

- Rear lamps
 - Messages in display 418
- Rear lamps see Tail lamps
- Rear passenger compartment ventilation and
 - automatic climate control Deactivating 228
- Rear passenger compartment ventilation and rear
 - automatic climate control 227
- Rear passenger compartment ventilation and rear climate control 213
- Rear view mirror auto-dimming* 195
- Rear view mirrors see Mirrors
- Rear window defroster 200
 - Activating 201
 - Deactivating 201
- Rear window wiper/washer 57
- Rear wiper blade
 - Installing 455
 - Removing 454
- Recommended tire inflation pressure 366
- Reconnecting
 - Vehicle battery 464
- Recovery services
 - For stolen vehicle 289
- Refrigerant
 - Air conditioning 495
- Regular checks 324
- Reinstalling
 - Cup holder 275
- Remote control
 - Integrated 106
 - SmartKey 106
 - SmartKey with KEYLESS-GO* 110
- Remote door unlock
 - With Tele Aid* 288
- Removing
 - Cup holder 275
 - Front wiper blades 453
 - Rear wiper blade 454
 - Vehicle battery 464
 - Wheel 459
- Removing rear seat cushions (Vehicles with cargo management system*) 268
- Removing the mechanical key
 - Unlocking the vehicle 435
- Replacing
 - Backup lamp bulbs 450
 - Bulbs 443
 - Bulbs for rear lamps 450
 - Front fog lamp (ML 350, ML 500 with AMG Sport Package) 449
 - Front fog lamp (ML 350, ML 500) 449
 - Front lamp bulbs 445
 - Front turn signal bulbs 448
 - High beam halogen bulbs 447
 - License plate lamp bulbs 451
 - Low beam bulbs 446
 - Parking/standing lamp bulb 448
 - Rear fog lamp bulbs 450
 - Rear lamp bulbs 444, 450
 - Rear side marker lamp bulbs 450
 - Rear turn signal bulbs 450
 - Side marker lamp bulb 448
 - Turn signal bulb 448
 - Wiper blades 453
- Replacing front fog lamp bulb 449

Index

- Replacing key batteries
 - SmartKey with KEYLESS-GO* 441
- Reporting
 - Safety defects 19
- Reset button in the instrument cluster 161
- Resetting
 - All functions of a submenu 162
 - Fuel consumption 177
 - Maintenance service indicator 373
 - Trip odometer 149
- Residual heat utilization 212, 226, 227, 505
- Residual ventilation 212, 226
- REST (Residual engine heat utilization) 505
- Restraint system 505
- Restraint system see Infant and child restraint systems
- Returning from off-road driving 313
- Returning seat backrest to original position 262
- Rim 367
- Rims 487
- Roadside assistance 12
 - Tele Aid* 284
- RON 324
- RON (Research Octane Number) 505
- Roof rack* 269
- Rotating wheels 368
- Rubber parts
 - Cleaning 380
- Run Flat Indicator 348
- S**
- Safety
 - Occupant 66
- Safety belts see Seat belts
- Safety defects
 - Reporting 19
- Safety systems
 - Driving 93
- Seat backrest
 - Returning to original position 262
- Seat belt force limiter 76
- Seat belt height adjustment 48
- Seat belts 73
 - Cleaning 379
 - Fastening 46
 - Height adjustment 48
 - Proper use of 48, 74
 - Safety guidelines 70
 - Warning lamp 388, 389

- Seat cushion depth
 - Adjusting 132
- Seat heating*
 - Switching off 134
 - Switching on 134
- Seating capacity 340
- Seats 128
 - Adjusting 38
 - Easy entry/exit feature (Vehicles with memory function*) 128
 - Heater* 133
 - Multicontour seat* 132
- Securing cargo
 - Cargo tie-down rings 260
- Selecting display 165
- Self-test
 - Occupant Classification System 86
 - Tele Aid* 282
- Service
 - Calling up the service indicator 372
 - Parts 482
- Service and Warranty Booklet
 - Loss of 483
- Service and warranty information 10
- Service indicator
 - Calling up 372
 - Clearing 372
- Service life (tires) 336
- Setting
 - Convenience functions 163, 173
 - Cruise control 239
 - Day (clock) 166
 - Daytime running lamp mode 167, 168
 - Higher speed in cruise control 241
 - Hours (clock) 165
 - Individual vehicle settings 161
 - Interior lighting delayed switch-off 170
 - Lamps and lighting (control system) 167
 - Language, multifunction display 164
 - Locator lighting 168
 - Lower speed in cruise control 242
 - Miles/kilometers in speedometer 164
 - Minutes (clock) 166
 - Month (clock) 166
 - Parking position* for exterior rear view mirrors 174
 - Slower speed in cruise control 242
 - Speed in cruise control 243
 - Speedometer display mode 164
 - Temperature (interior) 207, 221
 - Units
 - Speedometer 164
 - Year (clock) 167
- Setting current speed 239
- Setting the vehicle level* 252
- Setting up the collapsible wheel chock
 - Vehicle tool kit 432
- Settings
 - Convenience functions 173
 - Factory, SmartKey 108
 - Lighting (control system) 167
 - Menus and submenus 152
 - Resetting all (control system) 161
 - Resetting in the submenu 162
 - Selective 108, 114

Index

- Settings menu
 - Individual vehicle settings 161
 - Submenus 161, 162
- Shifting
 - Gear selector lever positions 185
 - Into optimal gear range (automatic transmission) 190
- Side impact air bags 72
- Side marker lamp
 - Replacing bulbs 443
- Side marker lamp bulb
 - Replacing 448
- Side marker lamps
 - Replacing bulbs 444
- Side markers
 - Vehicle care 377
- Side windows 230
 - Automatic opening 232
 - Cleaning 378
 - Closing 230, 231
 - Closing with KEYLESS-GO* 234
 - Opening 230
 - Opening fully (Express-open) 232
 - Stopping 232
 - Synchronizing power windows 232
- Sidewall 367
- Simultaneous wiping and washing
 - Rear window wiper/washer 58
 - Windshield wipers 56
- Single wipe 56
- SmartKey 106
 - Battery check lamp 108, 114
 - Checking the batteries 109, 115
 - Factory setting 108
 - Global locking 108
 - Global locking and unlocking 108
 - Global unlocking 108
 - Loss of 110
 - Selective setting 108
 - Starter switch positions 34
 - Turning off engine 62
 - Unlocking with 32
- SmartKey with KEYLESS-GO* 110
 - Factory setting 113
 - Global locking 113
 - Loss of 116
 - Messages in display 417
 - Remote control 110
 - Replacing key batteries 441
 - Selective setting 114
 - Unlocking 110

- Snow chains 370
- Spare fuses 478
- Spare wheel 433
 - Minispare wheel 433
- Speed
 - Setting current 239
- Speed settings
 - Cruise control 241, 242, 243
- Speedometer 25
 - Settings units 164
- Speedometer display mode
 - Selecting 164
- Split rear bench seat 261
- SRS 74, 505
 - Indicator lamp 390
- SRS indicator lamp 25
- Standing water
 - Driving instructions 305
- Starting difficulties 51
- Starting position 34
- Starting the engine 49
- Steep terrain
 - Driving 308
- Steering column
 - Height adjustment 43
 - Length adjustment 43
- Steering wheel
 - Adjusting 41
 - Cleaning 379
 - Electrical adjustment* 42
- Steering wheel gearshift control 188
- Stolen vehicle
 - Recovery services 289
- Stopping
 - Windows 232
- Storage compartment
 - in the center console 271
- Storage compartments 270
 - Armrest 272
 - Cup holder 274
 - Glove box 270
 - Parcel net in front passenger footwell 270
 - Storage compartment in front of armrest 272
 - Storage compartment in the center console 271
- Storing (Memory function*)
 - Positions in memory 136
- Storing tires 337
- Stranded vehicle 476

Index

Submenus

- Convenience 173
- For settings 152
- In control system 154
- Instrument cluster 164, 165
- Lighting 167
- Resetting functions in Control system 162
- Selecting 162
- Settings menu 162
- Vehicle 171
- Sun visor 198
- Supplemental Restraint System see SRS
- Switching off
 - Automatic central locking (control system) 172
 - Corner-illuminating front fog lamps* 144
 - Downhill Speed Regulation (DSR) 245
 - ESP® 97
 - Hazard warning flasher 145
 - Headlamps 62
 - Seat heating* 134

Switching on

- Automatic central locking (control system) 172
- Corner-illuminating front fog lamps* 143, 144
- Downhill Speed Regulation (DSR) 245
- ESP® 98
- Front fog lamps 142
- Hazard warning flasher 145
- Headlamps 54
- High beams 142
- Low beam headlamps 54
- Rear fog lamp 142
- Seat heating* 134
- Windshield wipers 55
- Synchronizing
 - Power windows 232
 - Tilt/sliding sunroof* 237

T

- Tachometer 149
 - Displaying gear range 187
 - Overspeed range 149
- Tail lamps
 - Cleaning 377
- Tailgate
 - Closing 120
 - Closing from the inside electrically* 120
 - Closing from the outside (vehicles without KEYLESS-GO*) 121
 - Message in display 427
 - Opening 118
 - Opening from the inside electrically* 118
 - Opening from the outside 118
 - Unlocking and opening the tailgate in an emergency 437
 - Unlocking and opening with KEYLESS-GO* 115
 - Unlocking with SmartKey 109

- Tar stains 375
- Technical data 495
 - Brake fluid 495
 - Coolants 497
 - Electrical system 490
 - Engine 486
 - Engine oil 495
 - Engine oil additives 495
 - Fuel requirements 496
 - Gasoline additives 497
 - Main dimensions 491
 - Premium unleaded gasoline 496
 - Rims and tires 487
 - Weights 492
 - Windshield washer and headlamp cleaning* system 500
- Tele Aid* 280
 - Call priority 287
 - Emergency calls 282
 - Information 286
 - Initiating an emergency call manually 284
 - Messages in display 425, 426
 - Remote door unlock 288
 - Roadside assistance 284
 - Stolen vehicle recovery services 289
 - System self-check 282
- Tele Aid* System 505
- Telematics* 506
- Telephone* 279
 - Answering a call 179
 - Dialing a number from the phone book 180
 - Ending a call 180
 - Loading phone book* 180
 - Operating 178
 - Redialing 181
- Telephones and two-way radios 320
- Telescoping rod 268
- Temperature
 - Setting interior temperature 207, 221
 - Tires 346
- The coolant level is correct if the level 333
- Tie-down rings (Cargo compartment) 260
- Tightening torque 506
- Tightening torque (Wheel bolts) 461
- Tilt
 - Head restraint 41
- Tilt/sliding sunroof*
 - Closing 235
 - Closing with KEYLESS-GO* 234
 - Opening 235
 - Synchronizing 237

Index

- Time
 - Setting day 166
 - Setting hours 165
 - Setting minutes 166
 - Setting month 166
 - Setting year 167
- TIN 367
- Tire
 - Vehicle maximum load on 368
- Tire and Loading Information 339
- Tire and loading terminology 365
- Tire care and maintenance 336
- Tire Identification Number see TIN
- Tire inflation pressure
 - Checking 325, 345, 347
- Tire inflation pressure see
 - the placard on the fuel filler flap
- Tire inspection 336
- Tire load rating 367
- Tire ply composition and material used 367
- Tire speed rating 303, 357, 367, 506
- Tire terminology 365
- Tire traction 303
- Tires 487
 - Direction of rotation 338
 - Driving instructions 302
 - Low tire pressure telltale 391
 - Retreads 335
 - Rims and tires 487
 - Run Flat Indicator 348
 - Service life 336
 - Temperature 346, 364
 - TPMS malfunction telltale 391
 - Tread depth 337, 369
 - Wear pattern 368
 - Winter 369
- Tools 430
- Tow-away alarm 102
 - Arming 102
 - Disarming 102
 - Disarming for transport 102
- Towing
 - Trailer 314
- Towing a trailer 317
 - Automatic transmission 191
- Towing the vehicle
 - Installing towing eye bolt 474
 - Stranded vehicle 476
- Traction 367, 506
- Trailer
 - Attaching 316
 - Loading 315
 - Towing 317

Trailer hitches* 314
Trailer towing 314
 Attaching a trailer 316
 Checking weights 315
 Electrical connections 314
 Hitches* 314
 Loading 315
 Weights and ratings 315
Trailer weights and ratings 315
Transfer case 193, 506
Transmission positions 185
Tread 367
Tread depth 337
Tread depth (tires) 369
Treadwear indicators 367
Trip computer 177
Trip odometer
 Resetting 149

Turn signal bulb
 Replacing 448
Turn signal lamps
 Replacing bulbs 443, 444
Turn signals 54
 Additional in mirrors 443
 Cleaning lenses 377
 Front bulbs 443
 Rear bulbs 444, 451
Turning off
 Engine 62
Turning off engine 62
Turning off the engine 63
TWR (Tongue Weight Rating) 506

U

Uniform Tire Quality Grading
 Standards 367
Units
 Setting speedometer units 164
Unlocking 32, 106
 Centrally from inside 126
 Driver's door in an emergency 435
 Fuel filler flap 323
 Global 108
 Global (SmartKey with
 KEYLESS-GO*) 113
 In an emergency 435
 Selective settings 108, 114
 Tailgate with SmartKey 109
 Vehicle in an emergency 288
 With the SmartKey 32
 With the SmartKey with
 KEYLESS-GO* 110

Index

Unlocking and opening
 Tailgate with KEYLESS-GO* 115
Unlocking the vehicle
 Removing the mechanical key 435
Unlocking with KEYLESS-GO* 33
Uphill driving
 Cruise control 240
Upholstery
 Cleaning 380
Useful features 270
 Ashtrays and cigarette lighter* 275
 Cup holder 274
 Garage door opener 289
 Power outlet 277
 Storage compartments 270
 Tele Aid* 280
 Telephone* 279

V
Vehicle
 Data recording 20
 Individual settings 161, 163
 Locking in an emergency 436
 Lowering 460
 Proper use of 17
 Unlocking in an emergency 435
Vehicle and trailer weights and ratings 315
Vehicle capacity weight 367

Vehicle care
 Carpet 379
 Cup holder 379
 Engine cleaning 376
 Gear selector lever 379
 Hard plastic trim items 379
 Headlamps 377
 Instrument cluster 379
 Leather upholstery* 380
 Light alloy wheels 379
 MB Tex upholstery 380
 Ornamental moldings 377
 Paintwork 375
 Parktronic* system sensor 377
 Plastic and rubber parts 380
 Power washer 375
 Seat belts 379
 Side markers 377
 Steering wheel 379
 Tail lamps 377
 Tar stains 375
 Turn signal lenses 377
 Upholstery 380
 Vehicle washing 376
 Window cleaning 378
 Wiper blades 378

- Vehicle jack 431
- Vehicle level control* 250, 506
- Vehicle lighting
 - Checking 325
- Vehicle loading terminology 365
- Vehicle maximum load on the tire 368
- Vehicle tool kit 430
 - Setting up the collapsible wheel chock 432
- Vehicle washing 376
- VIN (Vehicle Identification Number) 506
- W**
- Warning indicators
 - Parktronic* 256
- Warning sounds
 - Drivers seat belts 75
 - Parking brake 53
- Warranty coverage 483
- Washer fluid see Windshield washer fluid
- Wear pattern (tires) 368
- Weights 492
- Wheel change
 - Tightening torque 461
- Wheels
 - Rotating 368
- Window curtain air bags 72
- Windows see Side windows
- Windshield
 - Defogging 208, 222
 - Refilling washer fluid 334
 - Replacing wiper blades 453
 - Washer fluid 333, 500
 - Washer system 500
- Windshield washer fluid 500
 - Message in display 427
 - Mixing ratio 500
 - Refilling 333
 - Wiping with 56
- Windshield washer system 500
- Windshield wipers 55
 - Fast wiper speed 55
 - Intermittent 55
 - Intermittent wiping 55
 - Interval wiping 56
 - Normal wiper speed 55
 - Rear window wiper/washer 57
 - Replacing wiper blades 453
 - Simultaneous wiping and washing 58
 - Single wipe 56
 - Switching on 55
 - Wiping with windshield washer fluid 56

Index

- Winter driving
 - Snow chains 370
 - Tires 369
 - Winter driving instructions 304
 - Winter tires 369
 - Wiper blades
 - Cleaning 378
 - Replacing 453
 - Wiper switch 55
 - Wiper/washer
 - Rear window 57
 - Wiping
 - And washing simultaneously 56
 - Intermittent 55, 56
 - Interval 55
 - With windshield washer fluid 56
 - Wiping and washing simultaneously 58
- X**
- Xenon headlamps*
 - Bi-Xenon* 501

Service and Literature

Your authorized Mercedes-Benz Center has trained technicians and original Mercedes-Benz parts to service your vehicle properly. For expert advice and quality service, see your authorized Mercedes-Benz Light Truck Center.

If you are interested in obtaining service literature for your vehicle, please contact your authorized Mercedes-Benz Light Truck Center. We consider this the best way for you to obtain accurate information for your vehicle.

For further information you can find us on the Mercedes-Benz web-site *www.mbusa.com* or *www.mercedes-benz.ca*.

Warning!



To help avoid personal injury, be extremely careful when performing any service work or repairs. Improper or incomplete service or the use of incorrect or inappropriate parts or materials may damage the vehicle or its equipment, which may in turn result in personal injury.

If you have questions about carrying out any type of service, turn to the advice of an authorized Mercedes-Benz Light Truck Center.

We reserve the right to modify the technical details of the vehicle as given in the data and illustrations of this Operator's Manual. Reprinting, translation and copying, even of excerpts, is not permitted without our prior authorization in writing.

Title illustration no. P00.01-3040-31

Press time January 13, 2005

GSP/TIP

Printed in Germany

PDF Compressor Free Version