

P32.25-0254-09

16a Torsion bar spring
16b Counterplate

16c Screw
16f Screw

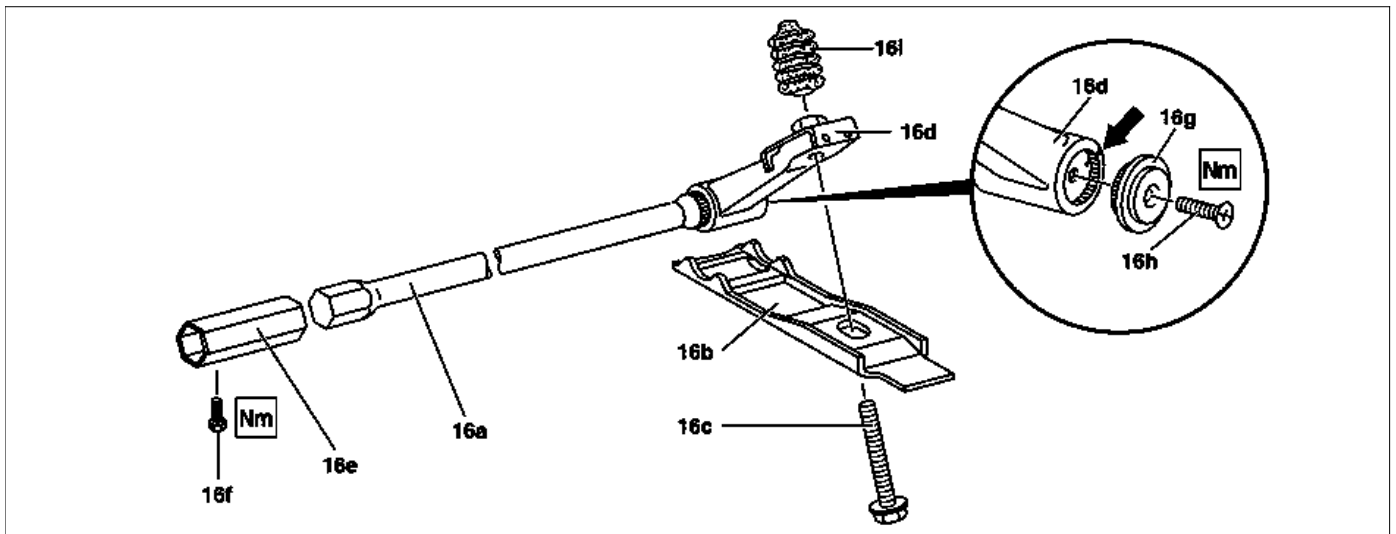





P32.20-0273-08

16a Torsion bar spring
16b Counterplate
16c Screw

16d Clamping lever
16e Profile sleeve
16f Screw

16g End cover
16h Screw
16i Rubber bellows

	Remove/install		
	Risk of death caused by vehicle slipping or toppling off of the lifting platform.	Align vehicle between the columns of the lifting platform and position the four support plates at the lifting platform support points specified by the vehicle manufacturer.	AS00.00-Z-0010-01A
1	Raise vehicle		
2	Measure initial spring tension of torsion bar spring (16a) using vernier caliper on bore	i Installation: Restore initial spring tension.	
3	Unscrew bolt (16c) and relieve pressure on torsion bar spring (16a)	i Installation: Grease bolt (16c) again. Rubber bellows (16i) must be filled with grease.	*BR00.45-Z-1005-06A
4	Release bolt (16f) from profile sleeve (16e)	Only up to model year 1999 Nm	*BA32.20-P-1001-01A
5	Slide back profile sleeve (16e)	i Sluggishness through soiling possible.	

6	Remove torsion bar spring (16a)	 Installation: Position of torsion bar spring (16a) marked relative to clamping lever (16d) (arrow).	
7	Undo bolt (16h). Remove end cover (16g)		*BA32.20-P-1002-01A
8	Pull torsion bar spring (16a) out of clamping lever (16d)	 Installation: Grease components.  Installation: Observe markings.	*BR00.45-Z-1005-06A
9	Install in the reverse order		
10	Check vehicle level at front and rear axle with electronic inclinometer and adjust if necessary		AR40.20-P-0301GH
11	Check and correct the adjustment of the headlamps  AP Check and correct the adjustment of the headlamps		AP82.10-P-8260GH

 **Front axle steel suspension**

Number	Designation		Model 163
BA32.20-P-1001-01A	Bolt to profile sleeve	Nm	23
BA32.20-P-1002-01A	Bolt to end cover	Nm	≈23

Repair materials

Number	Designation	Order number
BR00.45-Z-1005-06A	Paste, hot lubrication 1 kg, DB supply specification 6879.20	A 000 989 76 51