

P09.40-2224-09

- 1 Engine air intake duct downstream of air filter
 2 Engine charge air duct
 3 Heat shield
 4 Bracket
 5 Exhaust pipe

- 6 Screw/bolt
 7 Clamp
 8 Exhaust gas recirculation pipe
 9 Screw/bolts
 10 exhaust collector pipe

- 11 Screw/bolts
 12 Screw/bolts
 B60 Exhaust back pressure sensor
 Y27/9 Left exhaust gas recirculation positioner
 Y77/1 **Boost pressure control**

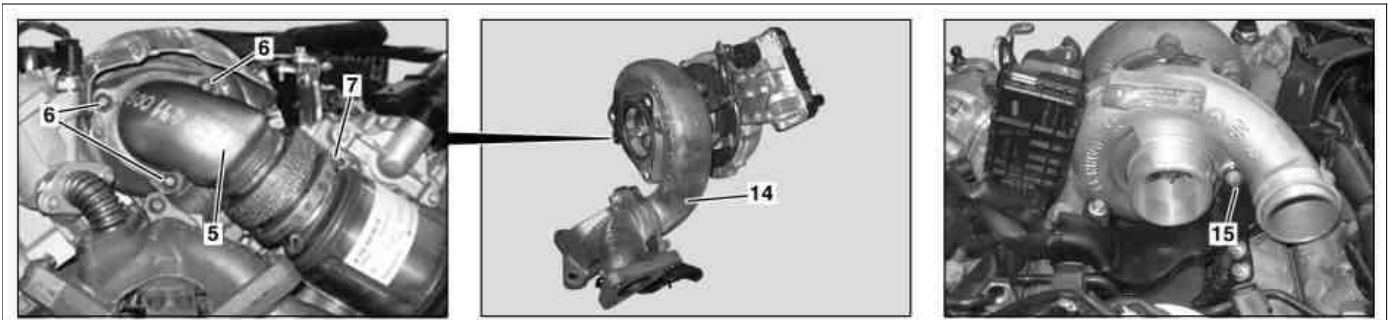

P09.40-2225-07

- 5 Exhaust pipe
 6 Screw/bolts

- 7 Clamp
 14 Turbocharger

- 15 Screw/bolt

- 16 Screw/bolts
- 17 Right partition wall
- 18 Center partition wall
- 19 Left partition wall

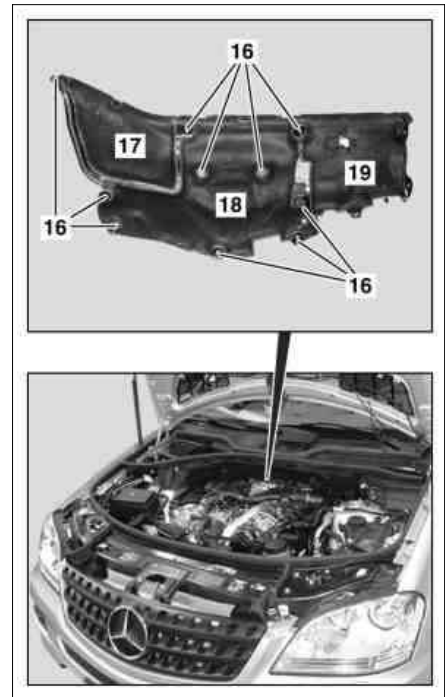

P62.25-2635-03

Turbocharger with coolant cooling

- 20 Coolant line
- 21 Screw/bolt
- 22 Clamp

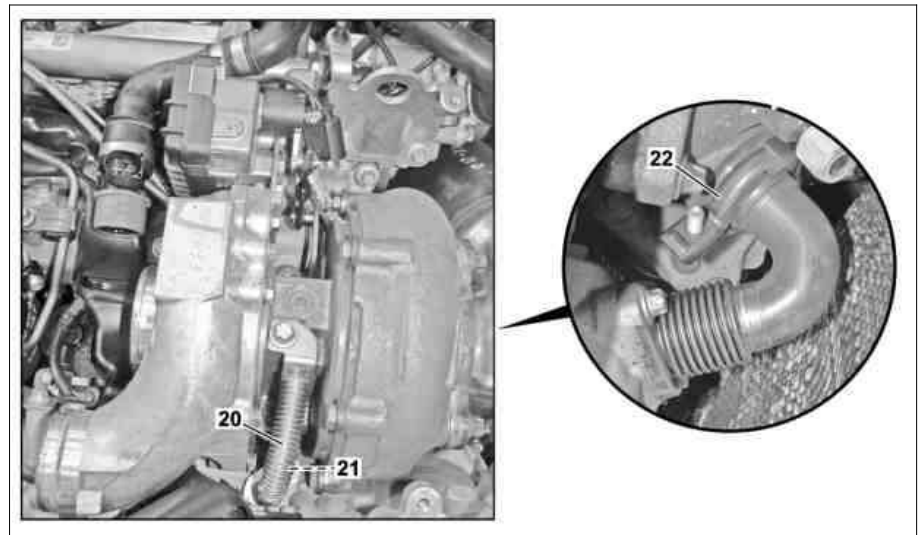







P09.40-2404-05

Modification notes

3.4.12	Value modified: Fit bolt, turbocharger to oil supply connection fitting, Stage 1		*BA09.40-P-1010-01K
	Value modified: Fit bolt, turbocharger to oil supply connection fitting, Stage 2		*BA09.40-P-1010-01K

	Remove/install		
Danger!	Risk of injury to skin and eyes caused by handling hot or glowing objects.	Wear protective gloves, protective clothing and safety glasses, if necessary.	AS00.00-Z-0002-01A
Danger!	Risk of injury caused by fingers being pinched or crushed when removing, installing or adjustment operations on hoods, doors, trunk lids, liftgates or sliding roof	Keep body parts and limbs well clear of moving components.	AS00.00-Z-0011-01A
1	Remove right air filter housing		AR09.10-P-1150GZC
2	Remove engine air intake duct downstream of the air filter (1)		AR09.10-P-8130GZB
3	Remove engine charge air duct (2) upstream of charge air cooler		AR09.41-P-8623GZB
4	Remove engine charge air duct (2) from turbocharger (14)		AR09.41-P-8622GZB
5	Remove heat shield (3) from turbocharger (14)		
6	Remove screw/bolts (16) for partition wall		

7	Remove the right partition wall (17)	i Installation: Check partition wall on the right (17) for damage. If damage to the partition wall on the right (17) is visible, particularly in the catalytic converter area of the exhaust system, then this must be replaced.	
8	Remove center partition wall (18)	i The left partition wall (19) remains in the vehicle.	
9.1	Disconnect connector from exhaust back pressure sensor (B60)	With code (474) diesel particulate filter	
9.2	Remove exhaust back pressure sensor (B60)	Except code (474) diesel particulate filter	
10	Remove left exhaust gas recirculation positioner (Y27/9)		AR14.20-P-1020GZB
11	Disconnect electrical connector from boost pressure control (Y77/1)		
12	Remove hose clamp (7) at exhaust pipe (5)		
13	Remove screw/bolts (6)	i Remove top screw/bolts (6) but only loosen bottom screw/bolt (6) as the flange is slotted. i Installation: Replace seal and screw/bolts (6). Nm	*BA09.40-P-1012-01K
14	Remove exhaust pipe (5)		
15	Remove exhaust gas recirculation pipe (8)	i Installation: Replace seal and screw/bolts. i Installation: On engine with coolant-cooled turbocharger (14), check clamp (22), replace if necessary. Nm Nm Nm	*BA14.20-P-1003-01G *BA14.20-P-1004-01G *BA14.20-P-1013-01G
16	Remove screw/bolts (9)	i Installation: Replace seals and screw/bolts (9). Nm	*BA14.10-P-1001-01L
17	Drain coolant Notes on coolant	For a turbocharger (14) with coolant cooling	AR20.00-P-1142GZB AH20.00-N-2080-01A
18	Remove screw/bolt (21) for coolant line (20)	For a turbocharger (14) with coolant cooling Nm	*BA09.40-P-1013-01K
19	Remove screw/bolts (11) from carrier (bolts connecting carrier to crankshaft housing)	Nm	*BA09.40-P-1007-01K
20	Remove screw/bolts (12) from the oil supply connection fitting	Nm	*BA09.40-P-1010-01K
21	Remove bracket (4)		
22	Remove screw/bolt (15)	Nm	*BA09.40-P-1009-01K
23	Disconnect electrical connector from temperature sensor upstream of turbocharger (B19/11)	For a turbocharger (14) with coolant cooling	
24	Remove turbocharger (14)	i Replace seal for oil supply connection fitting and align with the hole pattern. Ensure that the oil supply duct is not concealed. Damage can occur on the turbocharger (14) otherwise. i Installation: Close off openings on turbocharger (14). Clean turbocharger (14) and primary catalytic converter free of sealant residues. i Installation: Close off openings on a removed oil supply connection fitting. i Installation: On engines with coolant-cooled turbocharger (14), replace seal for coolant line. S S	*001589019100 *129589009100
25	Replace seal between turbocharger (14) and exhaust collector pipe (10)	i Only in the event of leaks between turbocharger (14) and exhaust collector pipe (10). i To achieve tension-free installation and to prevent consequential damage to exhaust manifold, a provisional installation should be carried out to establish positioning of exhaust collector pipe (10) at turbocharger (14). i Installation: Install new screw/bolts.	AR09.40-P-6024-15A

			*BA09.40-P-1011-01K
26	Install in the reverse order		
	Checking		
27	Check engine oil level	 Vehicle must be horizontal and standing on its wheels. Measurement errors can occur otherwise.  Shut off engine once it has reached operating temperature and wait approx. 5 minutes before checking engine oil level.  Except code (474) diesel particulate filter  With code (474) diesel particulate filter	AR18.00-P-3035-01PI *BF18.00-P-1001-01A *BF18.00-P-1001-01S
 Danger!	Risk of accident caused by vehicle starting off by itself when engine is running. Risk of injury caused by contusions and burns from working on the vehicle as it is being started or when the engine is running	Secure vehicle to prevent it from starting off by itself. Wear closed and snug-fitting work clothes. Do not touch hot or rotating parts.	AS00.00-Z-0005-01A
28	Check for leaktightness with engine running		

Exhaust manifold

Number	Designation	Engine 642		
BA14.10-P-1001-01L	Flange connection, exhaust manifold/front exhaust pipes to exhaust collector pipe	Stage 1	Nm	20
		Stage 2	∠°	90

Exhaust gas recirculation

Number	Designation	Engine 642.82/83/ 85/86/87/ 886/9		
BA14.20-P-1003-01G	Exhaust gas recirculation pipe to charge air distribution line		Nm	13
BA14.20-P-1004-01G	Exhaust gas recirculation pipe to exhaust collector pipe	Stage 1	Nm	10
		Stage 2	∠°	90
BA14.20-P-1013-01G	Clamp, exhaust gas recirculation pipe to exhaust collector pipe		Nm	9

Turbocharger

Number	Designation	Engine 642		
BA09.40-P-1007-01K	Screw/bolt, exhaust collector pipe support brace to cylinder crankcase		Nm	20
BA09.40-P-1009-01K	Screw/bolt, turbocharger to charge air manifold		Nm	9
BA09.40-P-1010-01K	Fit bolt, turbocharger to oil supply connection fitting	Stage 1	Nm	20

		Stage 2	∠°	60
BA09.40-P-1011-01K	Screw/bolt, turbocharger to exhaust collector pipe	Stage 1	Nm	20
		Stage 2	∠°	90
BA09.40-P-1012-01K	Exhaust line to turbocharger		Nm	20
BA09.40-P-1013-01K	Screw/bolt, coolant line to turbocharger/charge air distribution line		Nm	9

📄 Engine lubrication system

Number	Designation	Engine 642.820/822/870/ 872 with diesel particulate filter	Engine 642.940/950 with diesel particulate filter
BF18.00-P-1001-01S	Engine oil Filling capacity (oil and filter change)	Liters	8.5
	Specifications for Operating Fluids	Sheet	BB00.40-P-0228-51A
		Sheet	BB00.40-P-0229-31A
		Sheet	BB00.40-P-0229-51A

📄 Engine lubrication system

Number	Designation	Engine 642.940/950 without diesel particulate filter	Engine 642.820/822/870 /872 without diesel particulate filter
BF18.00-P-1001-01A	Engine oil Filling capacity (oil and filter change)	Liters	8.5
	Specifications for Operating Fluids	Sheet	BB00.40-P-0228-03A
		Sheet	BB00.40-P-0228-05A
		Sheet	BB00.40-P-0228-51A
		Sheet	BB00.40-P-0229-03A
		Sheet	BB00.40-P-0229-31A
		Sheet	BB00.40-P-0229-05A
		Sheet	BB00.40-P-0229-51A

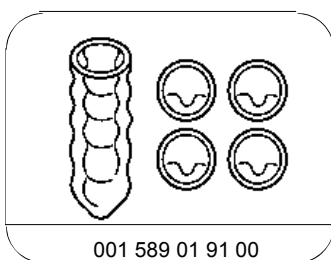

Set of protective covers

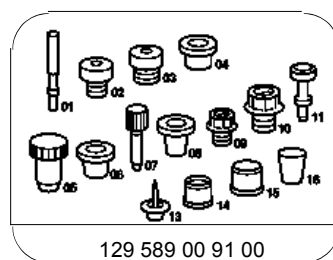

Set of stop plugs