

**Nm** Timing chain, chain tensioner

Number	Designation	Engine
		<b>642</b>
BA05.10-P-1005-01L	Bolt of rivet element in timing chain (reference value)	Nm 32



602 589 00 98 00

Case

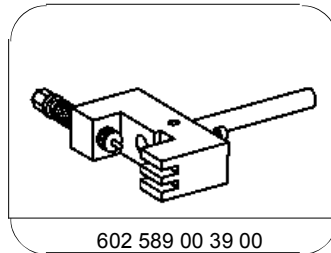

602 589 00 39 00

Riveting tool

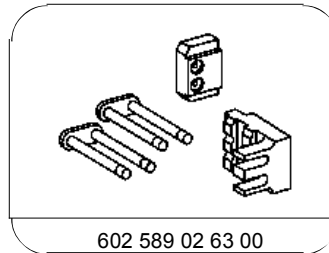

602 589 02 63 00

Assembly inserts

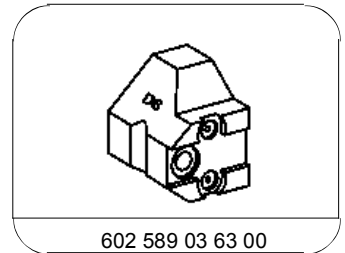

602 589 03 63 00

Thrust piece

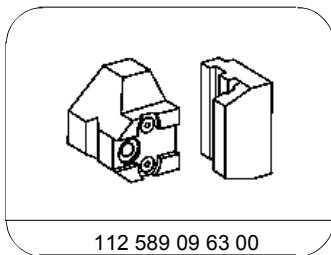

112 589 09 63 00

Assembly inserts

- Cover timing case recess and cylinder head with shop towel.
- ⚠ Parts, which have fallen into the timing case recess or cylinder head must be removed in order to prevent damage to the engine.

2 Insert new rivet element (7.1) and new middle plate (7.2) together with centering fork (3) into the ends of the new timing chain (1). Secure new center plate (7.2) with new rivet element (7.1).
- 3 Insert assembly insert (6) with the digit F5 into the rivet press tool (5) and fasten with screw.
- 4 Place assembly insert (7) with the digit D9 into the rivet press tool (5) .



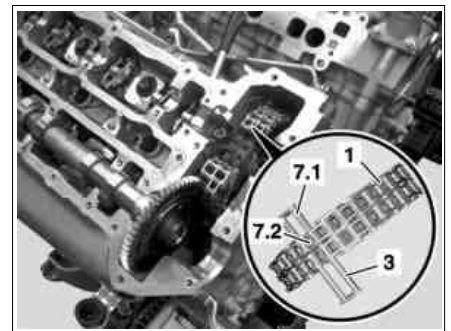

**i** The assembly insert (7) is able to move on the pressure pin and is loosely mounted.

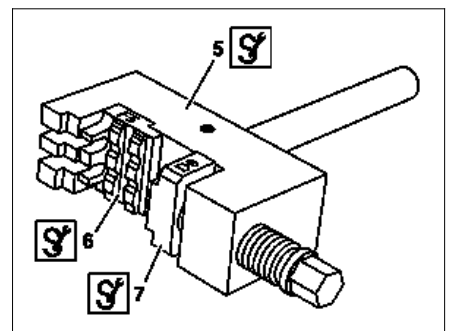

P05.10-2306-01





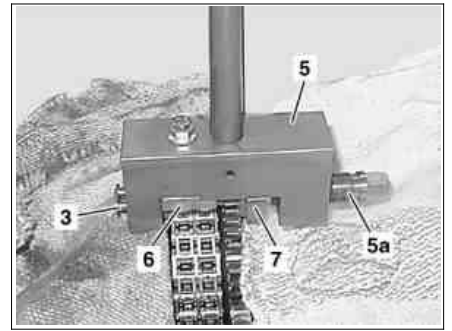

D05.10-1112-01

- 5 Press in new rivet element (7.1) with the rivet press tool (5)  as far as the stop.
- i** Ensure that the rivet element (7.1) and the rivet press tool (5)  are aligned. Do not allow the centering fork (3) which is pressed out to drop into the timing case recess.
- 6 Unscrew pressure pin (5a) and remove rivet press tool (5) .
- 7 Dismount assembly inserts (6, 7)  from rivet press tool (5) .



P05.10-2156-01

- 8 Place assembly insert (8)  with digit F1 into the rivet press tool (5)  and mount with mounting screw.
- 9 Place thrust piece (9)  with the digit D8 into the rivet press tool (5) .

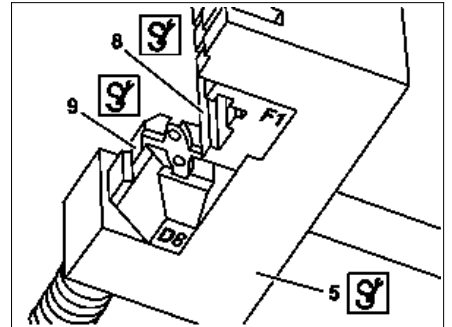

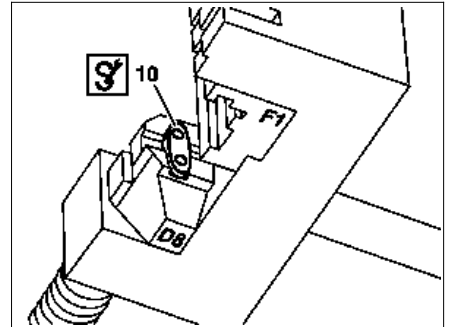

D05.10-1114-01

- 10 Place outer plate (10) into the thrust piece (9)  with the digit D8
- i** The new outer plate (10) is held by a magnet.



D05.10-1115-01

- 11 Fit on rivet press tool (5)  in such a way, that the spacer webs of the guide are supported (arrows).
- i** Ensure that the rivet element (7.1) and the new external plate (10) are aligned.
- 12 Screw in the pressure pin (5a) at the rivet press tool (5)  until there is solid resistance.
- i** When turning the pressure pin (5a), make sure that the pins of the new rivet element (7.1) break into the bores of the new external plate (10).
- 13 Remove the rivet press tool (5) .

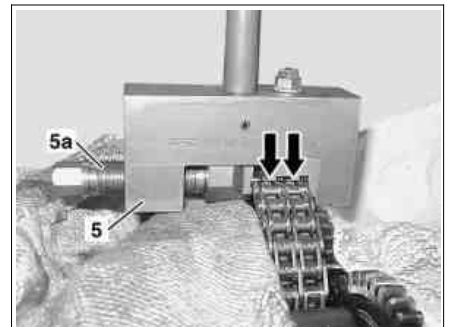





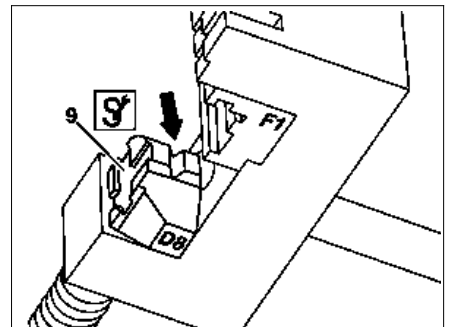

P05.10-2157-01

- 14 Turn over moving thrust piece (9)  onto the riveting section (arrow).



D05.10-1117-01

- 15 Attach rivet press tool (5)  to the center of one of the two timing chain bolts of the new rivet press tool (7.1) (arrow).
- 16 Tighten pressure pin (5a) of the rivet press tool (5)   and rivet first timing chain bolts of the new rivet element (7.1).
- 17 Loosen pressure pin (5a) and attach rivet press tool (5)  to second timing chain bolt of the new rivet element (7.1).
- 18 Tighten pressure pin (5a) of the rivet press tool (5)   and rivet second timing chain bolt.
- 19 Loosen pressure pin (5a) and remove rivet press tool (5) .
- 20 Check both rivets (arrows), re-rivet if required.
- 21 Remove rag from timing case recess and cylinder head.

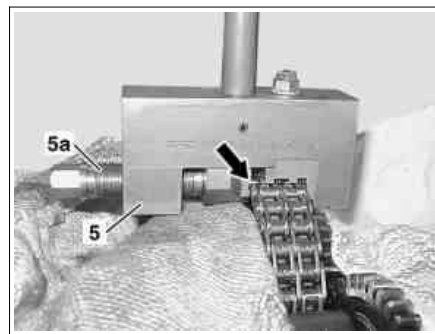

P05.10-2158-01

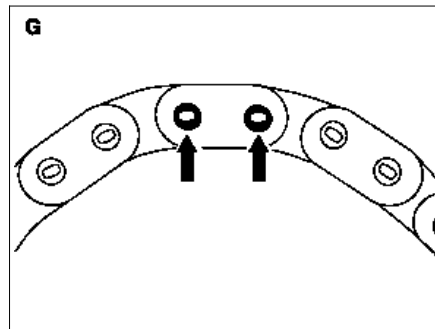

P05.10-0213-01