

N40/3 Amplifier for sound system

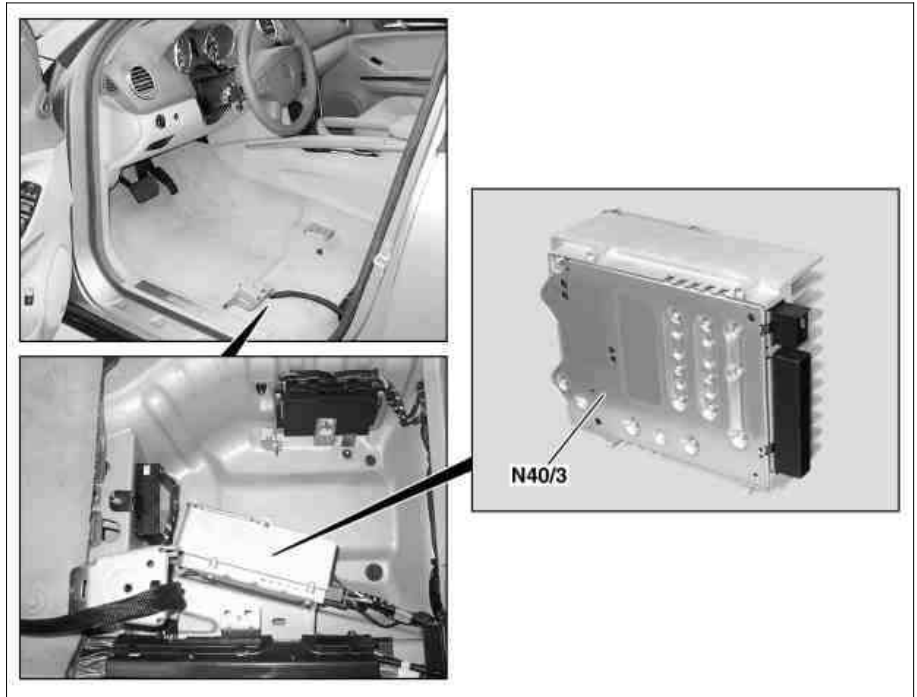

P82.62-2730-06

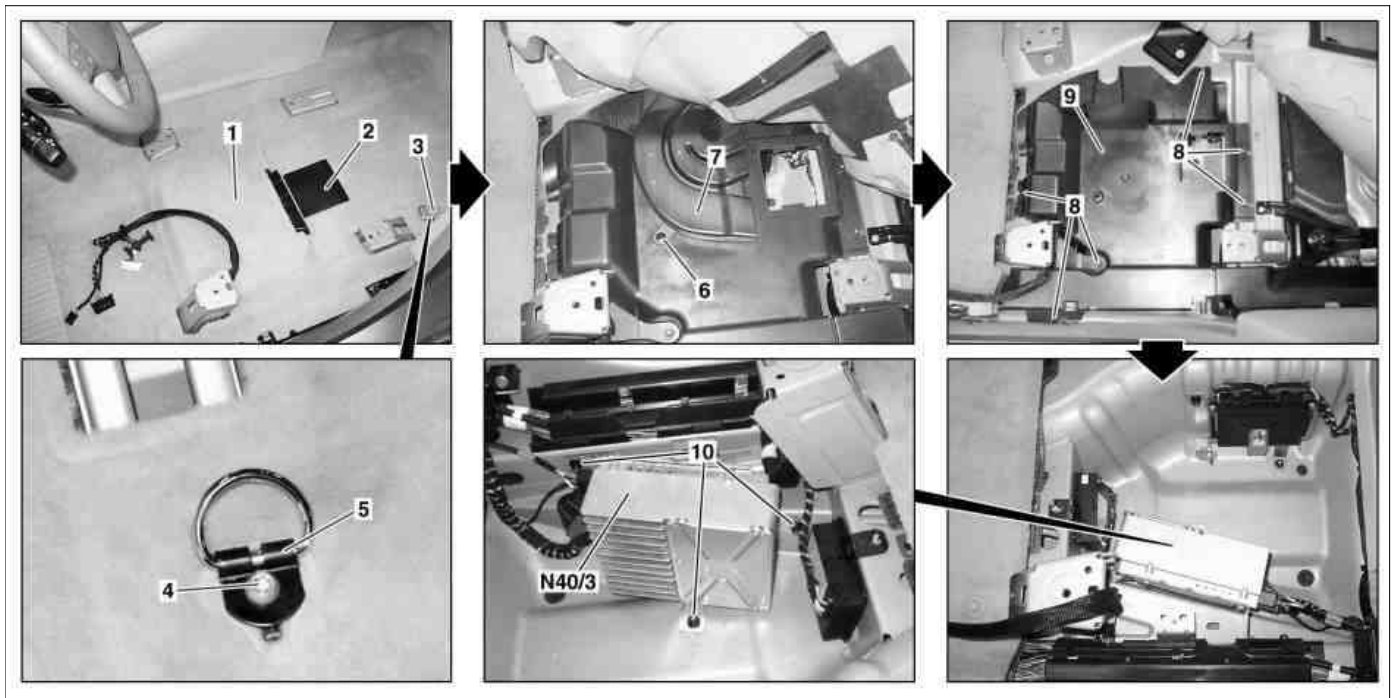

P82.62-2731-09

- 1 Rear floor covering
- 2 Cover
- 3 Anchoring lug cover
- 4 Bolt

- 5 Anchoring lug
- 6 Clip
- 7 Air duct
- 8 Nuts

- 9 Left intermediate bottom
- 10 Nuts

N40/3 Amplifier for sound system

- 11 Bolts
- 12 Bracket



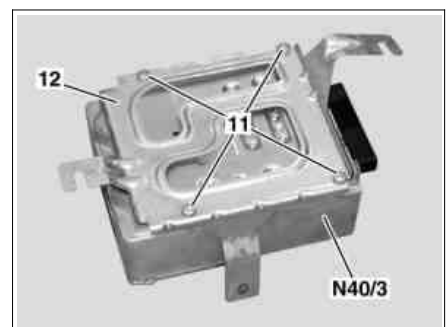





N40/3 Amplifier for sound system



P82.62-2732-01

Modification notes

26.7.06	Disconnect/connect ground line for battery and carry out basic programming removed	Steps 2 and 18	
---------	--	----------------	--

 	Remove/install		
	Notes on avoiding damage to electronic components due to electrostatic discharge		AH54.00-P-0001-01A
1	<p>Read out coding of amplifier for sound system (N40/3)</p> <p>Connect STAR DIAGNOSIS and read out fault memory</p>	<p>Only when replacing amplifier for sound system (N40/3) and when it can still be read out with STAR DIAGNOSIS.</p> <p>STAR DIAGNOSIS diagnosis system</p>	<p>AD00.00-P-2000-04A</p> <p>*WH58.30-Z-1048-13A</p>
 AD			
2	Remove left front seat		AR91.10-P-1000GZ
3	Remove left front door sill molding		AR68.30-P-4100GZ
4	Remove left rear door sill molding		AR68.30-P-4100GZ
5	Remove B-pillar paneling at bottom left		AR68.30-P-4700GZ
6	Remove cover (2).		
7	Remove anchoring lug cover (3)		
8	Remove bolt (4) and remove anchoring lug (5)	<p> Installation: Insert anchoring lug with its positioning tab properly aligned.</p> <p></p>	*BA68.50-P-1001-03F
9	Fold over left rear floor covering (1)		
10	Remove clip (6) and remove air duct (7)		
11	Remove nuts (8) and remove left intermediate bottom (9)		
12	Disconnect electrical connectors from amplifier for sound system (N40/3)	 Cover fiber optic cable using suitable means.	
13	Remove nuts (10) and remove amplifier for sound system (N40/3) together with bracket		
14	Remove bolts (11) and remove bracket (12) from amplifier for sound system (N40/3)		
15	Install in the reverse order		
16	<p>Code amplifier for sound system (N40/3)</p> <p>Connect STAR DIAGNOSIS and read out fault memory</p>	<p>Only when installing new amplifier for sound system (N40/3).</p> <p>STAR DIAGNOSIS diagnosis system</p>	<p>AD00.00-P-2000-04A</p> <p>*WH58.30-Z-1048-13A</p>
 AD			

Cargo retainers

Number	Designation	Model
BA68.50-P-1001-03F	Bolt, cargo retainers to body	164.1/8
		Nm 24

Commercially available tools

Number	Designation	
WH58.30-Z-1048-13A	STAR DIAGNOSIS diagnosis system, Compact Passenger Car	6511 1801 00