

Model 164, 166, 292

Modification notes

21.04.2017	Supporting joint not individually replaceable.	Model 166, 292
------------	--	----------------

Shown on model 164.1

- 1 Brake cable
- 2 Fuse

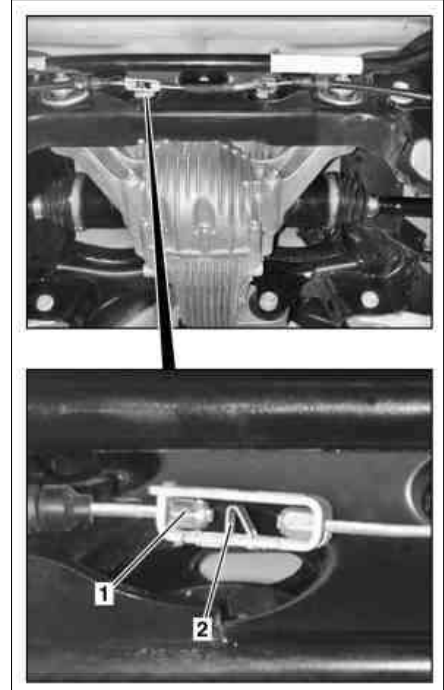

P35.30-2103-03

Shown on model 164.1

- 3 Collar nut
- 4 Nut
- 5 Camber strut
- 6 Screw
- 7 Tie rod
- 8 Nut
- 9 Strut rod

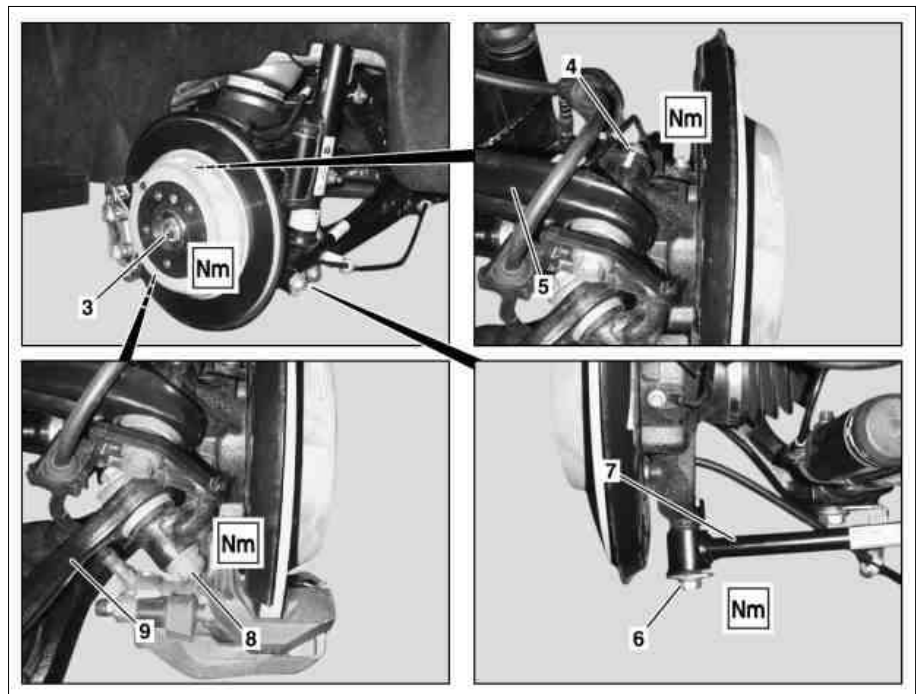

P35.30-2104-06





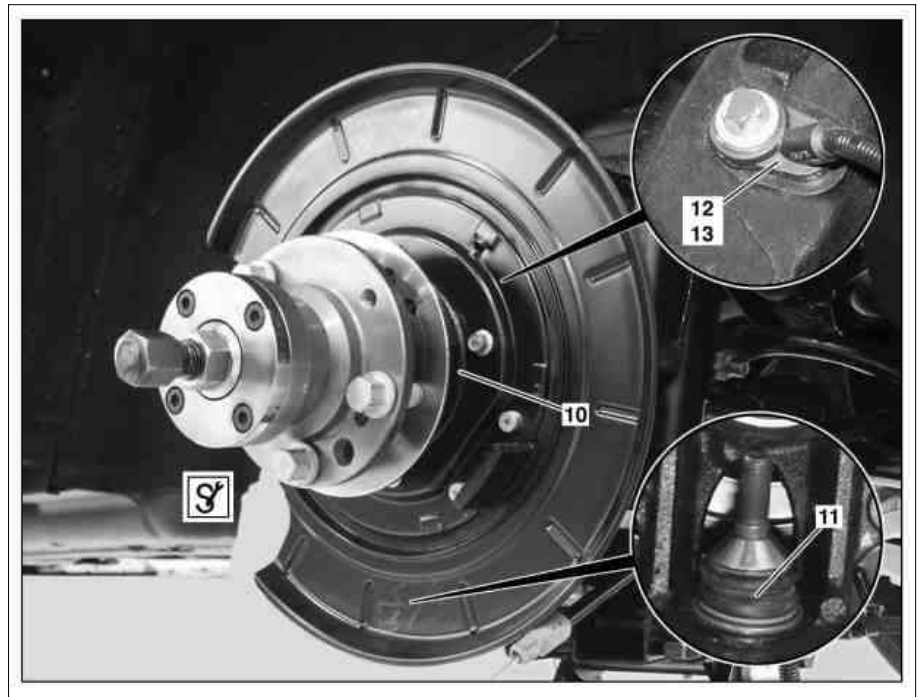







Shown on model 164.1

- 10 Wheel carrier
- 11 Supporting joint
- 12 Left rear rpm sensor
- 13 Right rear rpm sensor



P35.20-2361-06

Warning	Risk of injury caused by pinching or crushing when working on springs or spring bodies that are under tension	Use only approved tensioning devices; additionally screen off hazardous area if necessary. Check special tools for damage and proper operation (visual inspection). Wear protective gloves.	AS00.00-Z-0001-01A
Warning	Risk of injury. Moving parts can pinch, crush or, in extreme cases even sever extremities.	No parts of the body or limbs should be within the operating area of mechanical components when moving components.	AS00.00-Z-0009-01A
	Notes on installing brake hoses		AH42.10-P-9406-01A
	Notes on self-locking nuts and bolts		AH00.00-N-0001-01A
	Notes on repair work on suspension components		AH00.00-P-0100-01A
	Remove		
1	Secure vehicle on vehicle lift	Vehicle hoist securing tool	AR00.60-P-0100GZ *171589013100
2 AP AP	Remove complete wheel	Model 164 Model 166 Model 292	AP40.10-P-4050Z AP40.10-P-4050EW AR40.10-P-1100GQC
3	Unscrew collar nut (3) from rear axle shaft	A second person must operate the service brake.	
4	Unscrew brake caliper from brake caliper support	Model 164 Model 166, 292	AR42.10-P-0080GZ AR42.10-P-0080W
5	Fasten brake caliper with attached brake hose and electric lines onto vehicle	Fasten brake caliper in place free of any tension. Otherwise, the brake hose and electric lines may be damaged.	
6	Remove brake disk		AR42.10-P-0220GZ
7	Remove locking clip (2) and cut brake cable (1) in the middle	Model 164	
8	Remove parking brake shoes	Model 164	AR42.20-P-0530GZ
9	Remove brake cable (1) from wheel carrier (10)	Model 164	
10	Remove rear left rpm sensor (12) or rear right rpm sensor (13) from wheel carrier (10)		
11 WS	Raise wheel suspension on supporting joint (11) to driving level 000 588 11 62 00 Major assembly mount	To move the elastomer bearings for the suspension into the neutral position.	WS01.00-P-0092B
12	Unscrew bolt (6) of tie rod (7) from wheel carrier (10)		

13	Unscrew nut (4) of camber strut (5) from wheel carrier (10)		
14	Unscrew nut (8) of strut rod (9) from wheel carrier (10)		
15 WS	Slowly lower wheel suspension 000 588 11 62 00 Major assembly mount		WS01.00-P-0092B
16	Secure rear axle shaft on vehicle	 Secure rear axle shaft. The boots can otherwise be damaged.	
17	Press rear axle shaft out of the rear axle shaft flange	 Extraction and insertion tool	*210589034300
18	Unscrew nut from supporting joint (11)		
19	Remove wheel carrier (10)		
	Check		
20.1	Check supporting joint (11) and boot of supporting joint (11) on wheel carrier (10)	Model 166, 292 If a problem arises ↓ Replace wheel carrier (10).	
20.2	Check supporting joint (11) and boot of supporting joint (11) on wheel carrier (10)	Model 164 If a problem arises ↓ Replace supporting joint (11).	AR35.20-P-0117GZ
21	Remove brake cover plate	When replacing wheel carrier (10). Model 164 Model 166, 292	AR35.20-P-0130RT AR35.20-P-0130GQ
	Install		
22	Install brake cover plate	When replacing wheel carrier (10). Model 166, 292 Model 164	AR35.20-P-0130GQ AR35.20-P-0130RT
23	Install wheel carrier (10)		
24	Tighten nut on supporting joint (11)	 Self-locking nut, supporting joint to spring link/wheel carrier	*BA35.15-P-1003-02D
25	Remove locking clip from rear axle shaft		
26	Install rear axle shaft into rear axle shaft flange	 Extraction and insertion tool	*210589034300
27 WS	Raise wheel suspension on supporting joint (11) to driving level 000 588 11 62 00 Major assembly mount	 To move the elastomer bearings for the suspension into the neutral position.	WS01.00-P-0092B
28	Loosely screw in nut (8) of strut rod (9)		
29	Align dog bone washer between brake hose clip and camber strut (5) and loosely screw in nut (4)		
30	Loosely screw in bolt (6) of tie rod (7) on wheel carrier (10)		
31	Tighten bolt (6)	 Self-locking nut, tie rod to wheel carrier	*BA35.20-P-1002-04F
32	Tighten nut (4)	 Self-locking nut, camber strut to wheel carrier	*BA35.20-P-1002-02F
33	Tighten nut (8)	 Self-locking nut, strut rod to wheel carrier	*BA35.20-P-1002-03F
34 WS	Slowly lower wheel suspension on supporting joint (11) 000 588 11 62 00 Major assembly mount		WS01.00-P-0092B
35	Install rear left rpm sensor (12) or rear right rpm sensor (13) onto wheel carrier (10)	 Self-locking bolt, rpm sensor on rear axle to wheel carrier	*BA42.30-P-1001-02G
36	Install brake cable (1) into wheel carrier (10)	Model 164	
37	Install brake shows on parking brake	Model 164	AR42.20-P-0530GZ
38	Hook brake cable (1) into place	Model 164	
39	Install locking clip (2)	Model 164	
40	Install brake disk		AR42.10-P-0220GZ
41	Remove mounting for brake caliper and install brake caliper with attached brake hose and electric lines	Model 164 Model 166, 292	AR42.10-P-0080GZ AR42.10-P-0080W
42	Tighten new collar nut (3) of rear axle shaft	 Installation: Replace collar nut (3).  Model 164 Collar nut/bolt, rear axle shaft to rear axle shaft flange	*BA35.30-P-1001-01G

		Model 166, 292 Collar nut, rear axle shaft to rear axle shaft flange	*BA35.30-P-1001-01K
43	Adjust parking brake	Model 164	AR42.20-P-0540GZ
44	Remove rear complete wheel	Model 164 Model 166 Model 292	AP40.10-P-4050Z AP40.10-P-4050EW AR40.10-P-1100GQC
45	Remove vehicle lift safety device and lower vehicle		AR00.60-P-0100GZ

Trailing arms, transverse control arms

Number	Designation			Model 164.1/8	Model 166
BA35.15-P-1003-02D	Self-locking nut, supporting joint to spring link/ wheel carrier	Stage 1	Nm	205	180
		Stage 2	∠°	-	45

Trailing arms, transverse control arms

Number	Designation			Model 292
BA35.15-P-1003-02D	Self-locking nut, supporting joint to spring link/ wheel carrier	Stage 1	Nm	180
		Stage 2	∠°	45

Camber strut

Number	Designation			Model 164.1/8	Model 166
BA35.20-P-1002-02F	Self-locking nut, camber strut to wheel carrier	Stage 1	Nm	55	80
		Stage 2	∠°	90	90

Camber strut

Number	Designation			Model 292
BA35.20-P-1002-02F	Self-locking nut, camber strut to wheel carrier	Stage 1	Nm	80
		Stage 2	∠°	90

Strut rod

Number	Designation			Model 164.1/8	Model 166
BA35.20-P-1002-03F	Self-locking nut, strut rod to wheel carrier	Stage 1	Nm	50	80
		Stage 2	∠°	90	90

Strut rod

Number	Designation			Model 292
BA35.20-P-1002-03F	Self-locking nut, strut rod to wheel carrier	Stage 1	Nm	80
		Stage 2	∠°	90

Tie rod

Number	Designation			Model 164.1/8	Model 166
BA35.20-P-1002-04F	Self-locking nut, tie rod to wheel carrier		Nm	110	110

Tie rod

Number	Designation			Model 292
BA35.20-P-1002-04F	Self-locking nut, tie rod to wheel carrier		Nm	110

Nm Rear axle shaft

Number	Designation		Model 164
BA35.30-P-1001-01G	Collar nut/bolt, rear axle shaft to rear axle shaft flange	Stage 1	Nm 250
		Stage 2	45° 45

Nm Rear axle shaft

Number	Designation		Model 166	Model 292
BA35.30-P-1001-01K	Collar nut, rear axle shaft to rear axle shaft flange	Stage 1	Nm 250	250
		Stage 2	Loosen 45°	180
		Stage 3	Nm 200	200
		Stage 4	45° 30	30

Nm Rear axle rpm sensor

Number	Designation		Model 164.1/8	Model 166
BA42.30-P-1001-02G	Self-locking bolt, rpm sensor on rear axle to wheel carrier	Nm	8	8

Nm Rear axle rpm sensor

Number	Designation		Model 292
BA42.30-P-1001-02G	Self-locking bolt, rpm sensor on rear axle to wheel carrier	Nm	8

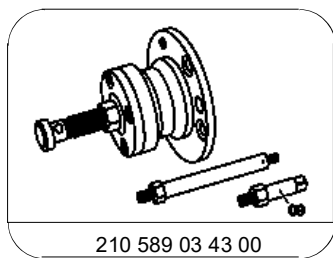

Extraction and insertion tool

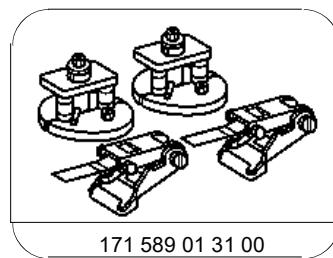

Vehicle hoist securing tool