

P09.40-2224-09

- |                                                   |                                  |                                                 |
|---------------------------------------------------|----------------------------------|-------------------------------------------------|
| 1 Engine air intake duct downstream of air filter | 6 Screw/bolt                     | 11 Screw/bolts                                  |
| 2 Engine charge air duct                          | 7 Clamp                          | 12 Screw/bolts                                  |
| 3 Heat shield                                     | 8 Exhaust gas recirculation pipe | B60 Exhaust back pressure sensor                |
| 4 Bracket                                         | 9 Screw/bolts                    | Y27/9 Left exhaust gas recirculation positioner |
| 5 Exhaust pipe                                    | 10 exhaust collector pipe        | Y77/1 Boost pressure control                    |

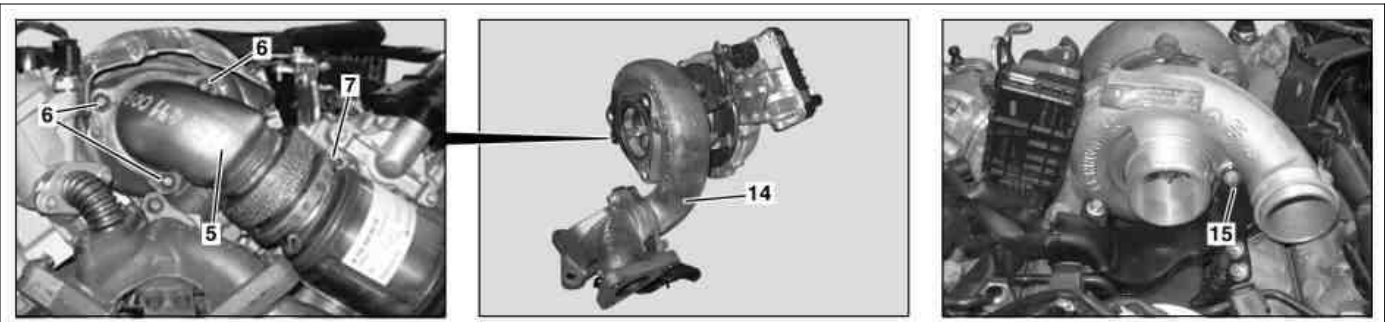

P09.40-2225-07

- |                |                 |               |
|----------------|-----------------|---------------|
| 5 Exhaust pipe | 7 Clamp         | 15 Screw/bolt |
| 6 Screw/bolts  | 14 Turbocharger |               |

- 16 Screw/bolts
- 17 Right partition wall
- 18 Center partition wall
- 19 Left partition wall

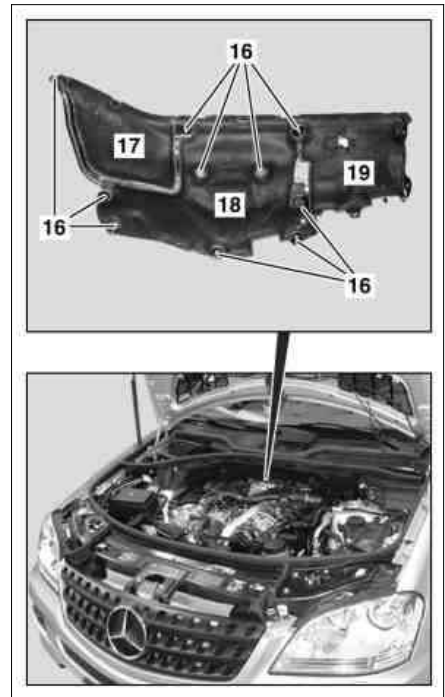

P62.25-2635-03

**Turbocharger with coolant cooling**

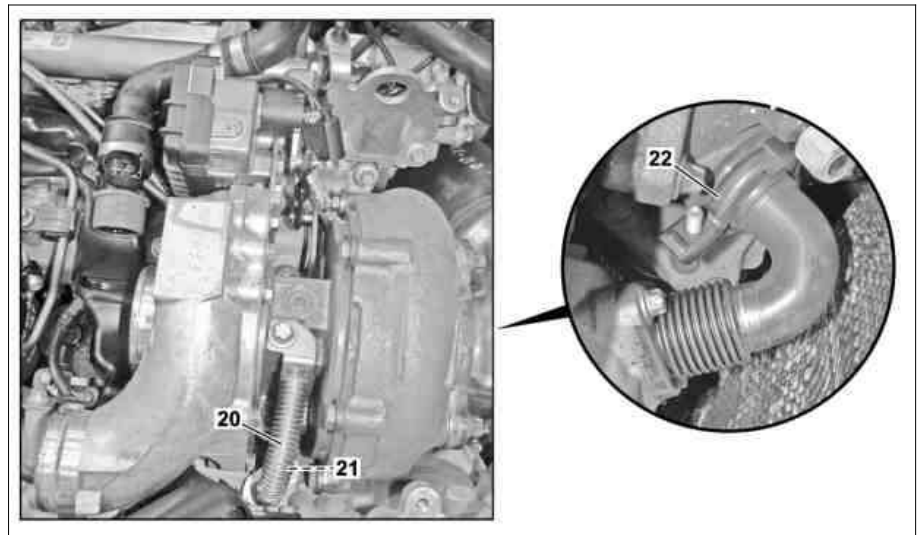

- 20 Coolant line
- 21 Screw/bolt
- 22 Clamp









P09.40-2404-05

**Modification notes**

|        |                                                                                  |  |                     |
|--------|----------------------------------------------------------------------------------|--|---------------------|
| 3.4.12 | Value modified: Fit bolt, turbocharger to oil supply connection fitting, Stage 1 |  | *BA09.40-P-1010-01K |
|        | Value modified: Fit bolt, turbocharger to oil supply connection fitting, Stage 2 |  | *BA09.40-P-1010-01K |

|   | Remove/install                                                                                                                                                                    |                                                                               |                    |
|------------------------------------------------------------------------------------------------------------------------------------------------------------------------|-----------------------------------------------------------------------------------------------------------------------------------------------------------------------------------|-------------------------------------------------------------------------------|--------------------|
|                                                                                                                                                                        | <b>Risk of injury</b> to skin and eyes caused by handling hot or glowing objects.                                                                                                 | Wear protective gloves, protective clothing and safety glasses, if necessary. | AS00.00-Z-0002-01A |
|                                                                                                                                                                        | <b>Risk of injury</b> caused by <b>fingers being pinched or crushed</b> when removing, installing or adjustment operations on hoods, doors, trunk lids, liftgates or sliding roof | Keep body parts and limbs well clear of moving components.                    | AS00.00-Z-0011-01A |
| 1                                                                                                                                                                      | Remove right air filter housing                                                                                                                                                   |                                                                               | AR09.10-P-1150GZC  |
| 2                                                                                                                                                                      | Remove engine air intake duct downstream of the air filter (1)                                                                                                                    |                                                                               | AR09.10-P-8130GZB  |
| 3                                                                                                                                                                      | Remove engine charge air duct (2) upstream of charge air cooler                                                                                                                   |                                                                               | AR09.41-P-8623GZB  |
| 4                                                                                                                                                                      | Remove engine charge air duct (2) from turbocharger (14)                                                                                                                          |                                                                               | AR09.41-P-8622GZB  |
| 5                                                                                                                                                                      | Remove heat shield (3) from turbocharger (14)                                                                                                                                     |                                                                               |                    |
| 6                                                                                                                                                                      | Remove screw/bolts (16) for partition wall                                                                                                                                        |                                                                               |                    |

|     |                                                                                           |                                                                                                                                                                                                                                                                                                                                                                                                                                                                                                                                                                                                       |                                                                   |
|-----|-------------------------------------------------------------------------------------------|-------------------------------------------------------------------------------------------------------------------------------------------------------------------------------------------------------------------------------------------------------------------------------------------------------------------------------------------------------------------------------------------------------------------------------------------------------------------------------------------------------------------------------------------------------------------------------------------------------|-------------------------------------------------------------------|
| 7   | Remove the right partition wall (17)                                                      | <b>i</b> <b>Installation:</b> Check partition wall on the right (17) for damage. If damage to the partition wall on the right (17) is visible, particularly in the catalytic converter area of the exhaust system, then this must be replaced.                                                                                                                                                                                                                                                                                                                                                        |                                                                   |
| 8   | Remove center partition wall (18)                                                         | <b>i</b> The left partition wall (19) remains in the vehicle.                                                                                                                                                                                                                                                                                                                                                                                                                                                                                                                                         |                                                                   |
| 9.1 | Disconnect connector from exhaust back pressure sensor (B60)                              | With code (474) diesel particulate filter                                                                                                                                                                                                                                                                                                                                                                                                                                                                                                                                                             |                                                                   |
| 9.2 | Remove exhaust back pressure sensor (B60)                                                 | Except code (474) diesel particulate filter                                                                                                                                                                                                                                                                                                                                                                                                                                                                                                                                                           |                                                                   |
| 10  | Remove left exhaust gas recirculation positioner (Y27/9)                                  |                                                                                                                                                                                                                                                                                                                                                                                                                                                                                                                                                                                                       | AR14.20-P-1020GZB                                                 |
| 11  | Disconnect electrical connector from boost pressure control (Y77/1)                       |                                                                                                                                                                                                                                                                                                                                                                                                                                                                                                                                                                                                       |                                                                   |
| 12  | Remove hose clamp (7) at exhaust pipe (5)                                                 |                                                                                                                                                                                                                                                                                                                                                                                                                                                                                                                                                                                                       |                                                                   |
| 13  | Remove screw/bolts (6)                                                                    | <b>i</b> Remove top screw/bolts (6) but only loosen bottom screw/bolt (6) as the flange is slotted.<br><b>i</b> <b>Installation:</b> Replace seal and screw/bolts (6).<br><b>Nm</b>                                                                                                                                                                                                                                                                                                                                                                                                                   | *BA09.40-P-1012-01K                                               |
| 14  | Remove exhaust pipe (5)                                                                   |                                                                                                                                                                                                                                                                                                                                                                                                                                                                                                                                                                                                       |                                                                   |
| 15  | Remove exhaust gas recirculation pipe (8)                                                 | <b>i</b> <b>Installation:</b> Replace seal and screw/bolts.<br><b>i</b> <b>Installation:</b> On engine with coolant-cooled turbocharger (14), check clamp (22), replace if necessary.<br><b>Nm</b><br><b>Nm</b><br><b>Nm</b>                                                                                                                                                                                                                                                                                                                                                                          | *BA14.20-P-1003-01G<br>*BA14.20-P-1004-01G<br>*BA14.20-P-1013-01G |
| 16  | Remove screw/bolts (9)                                                                    | <b>i</b> <b>Installation:</b> Replace seals and screw/bolts (9).<br><b>Nm</b>                                                                                                                                                                                                                                                                                                                                                                                                                                                                                                                         | *BA14.10-P-1001-01L                                               |
| 17  | Drain coolant<br>Notes on coolant                                                         | For a turbocharger (14) with coolant cooling                                                                                                                                                                                                                                                                                                                                                                                                                                                                                                                                                          | AR20.00-P-1142GZB<br>AH20.00-N-2080-01A                           |
| 18  | Remove screw/bolt (21) for coolant line (20)                                              | For a turbocharger (14) with coolant cooling<br><b>Nm</b>                                                                                                                                                                                                                                                                                                                                                                                                                                                                                                                                             | *BA09.40-P-1013-01K                                               |
| 19  | Remove screw/bolts (11) from carrier (bolts connecting carrier to crankshaft housing)     | <b>Nm</b>                                                                                                                                                                                                                                                                                                                                                                                                                                                                                                                                                                                             | *BA09.40-P-1007-01K                                               |
| 20  | Remove screw/bolts (12) from the oil supply connection fitting                            | <b>Nm</b>                                                                                                                                                                                                                                                                                                                                                                                                                                                                                                                                                                                             | *BA09.40-P-1010-01K                                               |
| 21  | Remove bracket (4)                                                                        |                                                                                                                                                                                                                                                                                                                                                                                                                                                                                                                                                                                                       |                                                                   |
| 22  | Remove screw/bolt (15)                                                                    | <b>Nm</b>                                                                                                                                                                                                                                                                                                                                                                                                                                                                                                                                                                                             | *BA09.40-P-1009-01K                                               |
| 23  | Disconnect electrical connector from temperature sensor upstream of turbocharger (B19/11) | For a turbocharger (14) with coolant cooling                                                                                                                                                                                                                                                                                                                                                                                                                                                                                                                                                          |                                                                   |
| 24  | Remove turbocharger (14)                                                                  | <b>i</b> Replace seal for oil supply connection fitting and align with the hole pattern. Ensure that the oil supply duct is not concealed. Damage can occur on the turbocharger (14) otherwise.<br><b>i</b> <b>Installation:</b> Close off openings on turbocharger (14). Clean turbocharger (14) and primary catalytic converter free of sealant residues.<br><b>i</b> <b>Installation:</b> Close off openings on a removed oil supply connection fitting.<br><b>i</b> <b>Installation:</b> On engines with coolant-cooled turbocharger (14), replace seal for coolant line.<br><b>S</b><br><b>S</b> | *001589019100<br>*129589009100                                    |
| 25  | Replace seal between turbocharger (14) and exhaust collector pipe (10)                    | <b>i</b> Only in the event of leaks between turbocharger (14) and exhaust collector pipe (10).<br><b>i</b> To achieve tension-free installation and to prevent consequential damage to exhaust manifold, a provisional installation should be carried out to establish positioning of exhaust collector pipe (10) at turbocharger (14).<br><b>i</b> <b>Installation:</b> Install new screw/bolts.                                                                                                                                                                                                     | AR09.40-P-6024-15A                                                |

|                                                                                  |                                                                                                                                                                                                                                                                               |                                                                                                                                                                                                                                                                                                                                                                                                                                                                                                                                                                                                                                                              |                                                                       |
|----------------------------------------------------------------------------------|-------------------------------------------------------------------------------------------------------------------------------------------------------------------------------------------------------------------------------------------------------------------------------|--------------------------------------------------------------------------------------------------------------------------------------------------------------------------------------------------------------------------------------------------------------------------------------------------------------------------------------------------------------------------------------------------------------------------------------------------------------------------------------------------------------------------------------------------------------------------------------------------------------------------------------------------------------|-----------------------------------------------------------------------|
|                                                                                  |                                                                                                                                                                                                                                                                               |                                                                                                                                                                                                                                                                                                                                                                                                                                                                                                                                                                               | *BA09.40-P-1011-01K                                                   |
| 26                                                                               | Install in the reverse order                                                                                                                                                                                                                                                  |                                                                                                                                                                                                                                                                                                                                                                                                                                                                                                                                                                                                                                                              |                                                                       |
|  | <b>Checking</b>                                                                                                                                                                                                                                                               |                                                                                                                                                                                                                                                                                                                                                                                                                                                                                                                                                                                                                                                              |                                                                       |
| 27                                                                               | Check engine oil level                                                                                                                                                                                                                                                        |  Vehicle must be horizontal and standing on its wheels. Measurement errors can occur otherwise.<br> Shut off engine once it has reached operating temperature and wait approx. 5 minutes before checking engine oil level.<br> Except code (474) diesel particulate filter<br> With code (474) diesel particulate filter | AR18.00-P-3035-01PI<br><br>*BF18.00-P-1001-01A<br>*BF18.00-P-1001-01S |
| 28                                                                               | <b>Risk of accident</b> caused by vehicle starting off by itself when engine is running. <b>Risk of injury</b> caused by contusions and burns from working on the vehicle as it is being started or when the engine is running<br>Check for leaktightness with engine running | Secure vehicle to prevent it from starting off by itself.<br>Wear closed and snug-fitting work clothes.<br>Do not touch hot or rotating parts.                                                                                                                                                                                                                                                                                                                                                                                                                                                                                                               | AS00.00-Z-0005-01A                                                    |

#### Exhaust manifold

| Number             | Designation                                                                       |         |    | Engine<br>642 |
|--------------------|-----------------------------------------------------------------------------------|---------|----|---------------|
| BA14.10-P-1001-01L | Flange connection, exhaust manifold/front exhaust pipes to exhaust collector pipe | Stage 1 | Nm | 20            |
|                    |                                                                                   | Stage 2 | ∠° | 90            |

#### Exhaust gas recirculation

| Number             | Designation                                                     |         |    | Engine<br>642.82/83/<br>85/86/87/<br>886/9 |
|--------------------|-----------------------------------------------------------------|---------|----|--------------------------------------------|
| BA14.20-P-1003-01G | Exhaust gas recirculation pipe to charge air distribution line  |         | Nm | 13                                         |
| BA14.20-P-1004-01G | Exhaust gas recirculation pipe to exhaust collector pipe        | Stage 1 | Nm | 10                                         |
|                    |                                                                 | Stage 2 | ∠° | 90                                         |
| BA14.20-P-1013-01G | Clamp, exhaust gas recirculation pipe to exhaust collector pipe |         | Nm | 9                                          |

#### Turbocharger

| Number             | Designation                                                            |         |    | Engine<br>642 |
|--------------------|------------------------------------------------------------------------|---------|----|---------------|
| BA09.40-P-1007-01K | Screw/bolt, exhaust collector pipe support brace to cylinder crankcase |         | Nm | 20            |
| BA09.40-P-1009-01K | Screw/bolt, turbocharger to charge air manifold                        |         | Nm | 9             |
| BA09.40-P-1010-01K | Fit bolt, turbocharger to oil supply connection fitting                | Stage 1 | Nm | 20            |

|                    |                                                                       |         |    |    |
|--------------------|-----------------------------------------------------------------------|---------|----|----|
|                    |                                                                       | Stage 2 | ∠° | 60 |
| BA09.40-P-1011-01K | Screw/bolt, turbocharger to exhaust collector pipe                    | Stage 1 | Nm | 20 |
|                    |                                                                       | Stage 2 | ∠° | 90 |
| BA09.40-P-1012-01K | Exhaust line to turbocharger                                          |         | Nm | 20 |
| BA09.40-P-1013-01K | Screw/bolt, coolant line to turbocharger/charge air distribution line |         | Nm | 9  |

### 📄 Engine lubrication system

| Number             | Designation                                         | Engine<br>642.820/822/870/<br>872 with diesel<br>particulate filter | Engine<br>642.940/950<br>with diesel<br>particulate filter |
|--------------------|-----------------------------------------------------|---------------------------------------------------------------------|------------------------------------------------------------|
| BF18.00-P-1001-01S | Engine oil Filling capacity (oil and filter change) | Liters                                                              | 8.5                                                        |
|                    | Specifications for Operating Fluids                 | Sheet                                                               | BB00.40-P-0228-51A                                         |
|                    |                                                     | Sheet                                                               | BB00.40-P-0229-31A                                         |
|                    |                                                     | Sheet                                                               | BB00.40-P-0229-51A                                         |

### 📄 Engine lubrication system

| Number             | Designation                                         | Engine<br>642.940/950<br>without diesel<br>particulate filter | Engine<br>642.820/822/870<br>/872 without<br>diesel<br>particulate filter |
|--------------------|-----------------------------------------------------|---------------------------------------------------------------|---------------------------------------------------------------------------|
| BF18.00-P-1001-01A | Engine oil Filling capacity (oil and filter change) | Liters                                                        | 8.5                                                                       |
|                    | Specifications for Operating Fluids                 | Sheet                                                         | BB00.40-P-0228-03A                                                        |
|                    |                                                     | Sheet                                                         | BB00.40-P-0228-05A                                                        |
|                    |                                                     | Sheet                                                         | BB00.40-P-0228-51A                                                        |
|                    |                                                     | Sheet                                                         | BB00.40-P-0229-03A                                                        |
|                    |                                                     | Sheet                                                         | BB00.40-P-0229-31A                                                        |
|                    |                                                     | Sheet                                                         | BB00.40-P-0229-05A                                                        |
|                    |                                                     | Sheet                                                         | BB00.40-P-0229-51A                                                        |

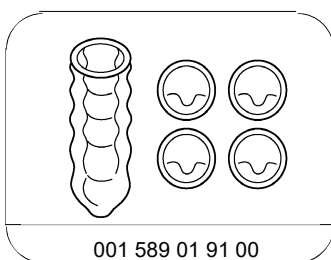

Set of protective covers

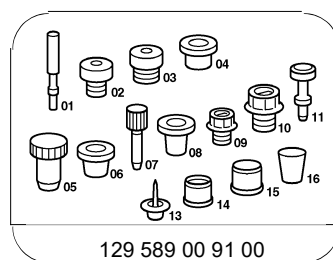

Set of stop plugs