



Driver Assistance Systems

Technology Guide



Mercedes-Benz

Preface	2
Driving systems	3
Overview	3
Blind Spot Assist/Active Blind Spot Assist	4
Lane Keeping Assist/Active Lane Keeping Assist	6
DISTRONIC/DISTRONIC PLUS	8
DISTRONIC PLUS with Steer Assist	12
Night View Assist/Night View Assist PLUS	14
Adaptive Highbeam Assist/Adaptive Highbeam Assist PLUS	17
Cruise control and Speedtronic	19
Downhill Speed Regulation	21
Speed Limit Assist/Traffic Sign Assist	22
ATTENTION ASSIST	24
Parking systems	26
Overview	26
PARKTRONIC/PARKTRONIC with Parking Guidance	27
Active Park Assist	29
Reversing camera	31
360° camera system	34
Driving Safety Systems	36
Overview	36
Brake Assist System (BAS/BAS PLUS)	37
Adaptive Brake Assist	38
Brake Assist System (BAS PLUS) with Intersection Assist	39
PRE-SAFE® brake	41
PRE-SAFE® PLUS	43
COLLISION PREVENTION ASSIST/ COLLISION PREVENTION ASSIST PLUS	45
Annex	47
Information and copyright	47

Preface

Dear Reader,

Driver assistance systems make driving easier by providing assistance and protection to the driver – and they help to make the Mercedes-Benz brand even more fascinating than before. Bring this fascination for the brand to life for your customers in your role as a service specialist.

This manual provides all of the important information you need about the driver assistance systems found in Mercedes-Benz cars. It is compact, clearly arranged and contains the most important facts about their operation as well as practical tips for service and diagnosis. It will help you to perform in accordance with the motto of "The Best or Nothing" in your customer consultations and when preparing your service jobs.

Global Service & Parts wishes you good luck!

Daimler AG

Retail Operation (GSP/OR)

Note

This manual is not subject to the ongoing update service. When working on the vehicle, always use the most up-to-date workshop aids (e.g. EPC net, WIS net, DAS, special tools) for the vehicle in question.

See the respective sales documentation for country-specific special considerations.

Driving systems	Abbreviation	SA code	Model series
Blind Spot Assist	BSM	234	117, 164, 166, 172, 176, 197, 204 MOPF, 207, 212, 218, 216/221 up to MY 2009, 246, 251 MOPF
Active Blind Spot Assist	BSM+	237	166, 204 MOPF, 207, 212, 216 MOPF, 218, 221 as of MY 2010, 222, 231
Lane Keeping Assist	ALDW	476	117, 166, 172, 176, 204 MOPF, 207, 212, 216 MOPF, 218, 221 MOPF, 231, 246
Active Lane Keeping Assist	LDP	238	166, 204 MOPF, 207, 216 MOPF, 212, 218, 221 MY 2011, 222, 231
DISTRONIC	DTR	219	209, 211/219, 220/215, 230, 164/251
DISTRONIC PLUS	DTR+	233/239	166, 172, 204 MOPF, 207, 212/218, 221/216, 207/212 MOPF, 222, 231 (code 233) 117, 176, 246, 463 MOPF (code 239)
DISTRONIC PLUS with Steer Assist	DTR+Q	266	207/212 MOPF, 222
Night View Assist	NV	610	216, 221
Night View Assist PLUS	NV+	610	166, 212, 218, 216/221 MOPF, 222, 231
Adaptive Highbeam Assist	IHC	608	117, 166, 172, 176, 204 MOPF, 207, 212, 216 MOPF, 218, 221 MOPF, 231, 246
Adaptive Highbeam Assist PLUS	IHC+	628	207/212 MOPF, 222
Cruise control	TPM	440	169, 203 up to MY 2005, 245 – non-braking cruise control 117, 164, 166, 171, 172, 176, 203, 204, 207, 209, 211, 212, 216, 218, 219, 221, 222, 230, 231, 246, 251 – braking cruise control
Speedtronic	LIM	440	169, 203 up to MY 2005, 245 – non-braking variable speed limiter 117, 171, 172, 176, 203, 204, 207, 211, 212, 216, 218, 219, 221, 222, 230, 231, 246, – braking variable speed limiter
Downhill Speed Regulation	DSR	430 ¹	164, 166, X204
Speed Limit Assist	SLA	513	117, 166, 172, 176, 204 MOPF, 207, 212, 216 MOPF, 218, 221 MOPF, 231, 246 As of MY 2012 Speed Limit Assist 1.5 207/212 MOPF, 222 Traffic Sign Assist
ATTENTION ASSIST	AA	538	117, 166, 172, 176, 204 MOPF (only with code 442), 207, 212, 216 MOPF, 218, 221 MOPF (without S400 Hybrid), 222, 231, 246

¹ Included with off-road package (code 430)

Blind Spot Assist/Active Blind Spot Assist

Features

The **Blind Spot Assist** system developed by Mercedes-Benz uses radar technology to monitor the area 3 m to the side and 3 m to the rear of the vehicle. The system becomes active as of 30 km/h and the yellow visual indicator in the outside mirrors then disappears. If the system detects another vehicle in the blind spot, this is indicated in the first stage by a red hazard warning triangle lighting up in the respective outside mirror. If the driver sets the turn signal despite the visual warning, an acoustic warning is issued additionally in a second stage.

The **Active Blind Spot Assist** system builds upon the functionality of Blind Spot Assist. This system can additionally help to avoid accidents in a third stage by performing a single-sided, targeted brake application to correct the course of the vehicle in a vehicle speed range of 30 - 200 km/h.

The driver is able to abort the course-correcting brake system intervention by countersteering at a steering angle of $> 5^\circ$ or by depressing the accelerator pedal to change its position by $> 10\%$.

Extended functionality on BR 222

The readiness indicator is displayed on the instrument cluster and not in the form of a visual indicator consisting of a yellow triangle in the outside mirror. The warning indicator is displayed in the outside mirror and on the instrument cluster.

System limits

False warnings can be issued near guardrails or concrete sidewalks and the system is automatically shut off in the vicinity of radio astronomy facilities by means of the navigation data.

Overtaking vehicles are reliably detected up to a speed differential of 35 km/h. During overtaking, warnings are issued up to a speed differential of 12 km/h. Vehicles with a higher speed differential may - under certain circumstances - be detected too late or not at all. As a consequence, any warning may then come too late or not at all.

At a vehicle speed of > 200 km/h, and in the event of heavy longitudinal or lateral acceleration, only a warning is issued and no course-correcting brake system intervention is performed.



Instrument cluster display for Blind Spot Assist

P54.33-3399-00

i Service information

No calibration is required. When accident repairs are performed, the paint coat thickness on the bumper must be observed and filler repairs may not be carried out in the area of the sensors on the bumper.

Blind Spot Assist components without additional control unit:

- 2 x short range sensors (NBR) in outer rear bumper

Blind Spot Assist components with additional control unit:

- 2 x NBR in outer rear bumper
- 1 x radar sensors control unit (SGR)
- On BR 221 before MOPF: 2 x NBR in front bumper, 4 x NBR in rear bumper

Components of Active Blind Spot Assist:

- 2 x NBR in outer rear bumper
- 1 x radar sensors control unit (SGR)
- 1 x long range radar

Diagnosis

- Radar sensors control unit (SGR)
- Outer left rear intelligent radar sensor control unit (IRS-HLA)
- Outer right rear intelligent radar sensor control unit (IRS-HRA) (with Blind Spot Assist without additional control unit)

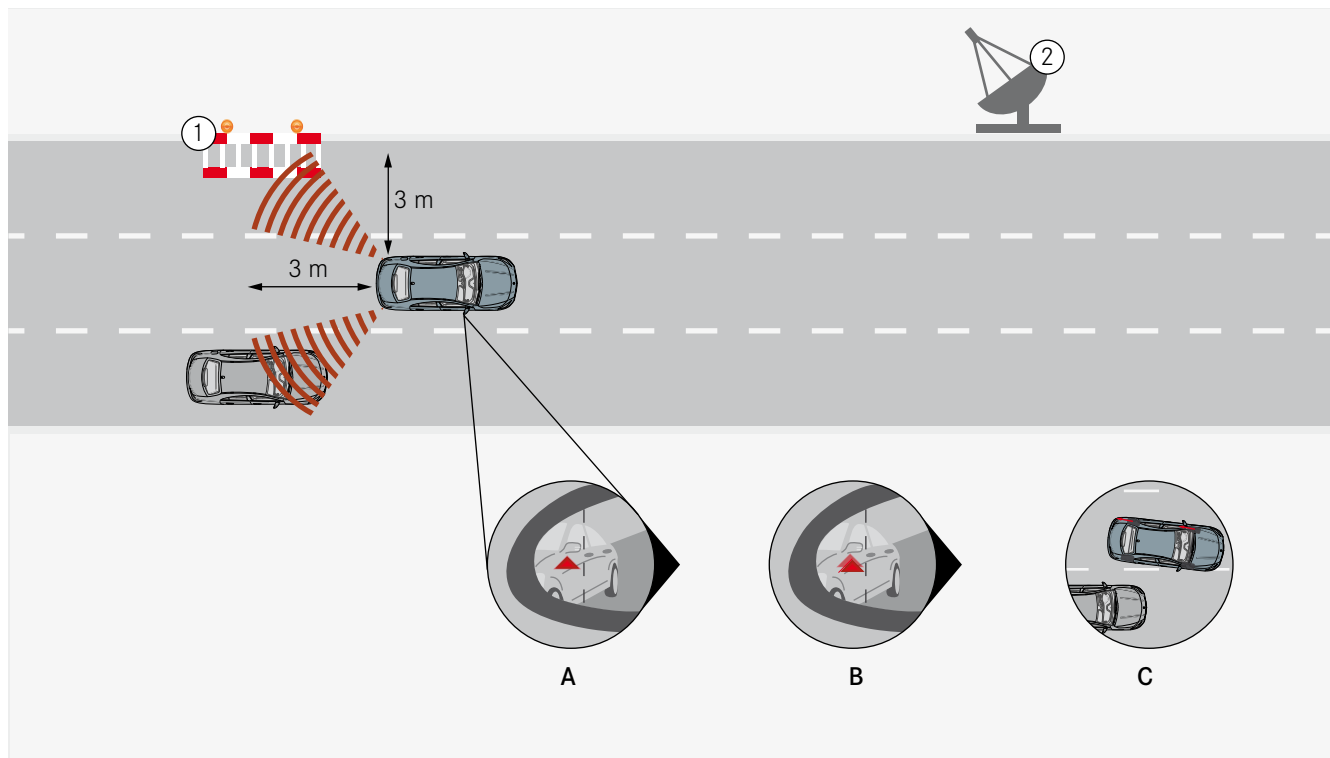
**Active Blind Spot Assist**

P54.33-3400-00

- 1 False warnings may be issued near guardrails or concrete sidewalls in roadwork zones.
- 2 The system shuts off automatically in the vicinity of certain radio astronomy facilities by means of navigation data.

- A Warning stage 1
- B Warning stage 2: If the driver sets the turn signal despite the warning, the red triangle flashes and an acoustic warning also sounds in the instrument cluster.
- C Warning stage 3: Course-correcting, single-sided brake system intervention if risk of side collision detected. (Only with Active Blind Spot Assist)

Lane Keeping Assist/Active Lane Keeping Assist

Features

The **Lane Keeping Assist** system from Mercedes-Benz helps the driver to keep the vehicle in its lane. The multifunction camera recognizes the lane markings through contrast comparison. If the system detects that the vehicle is unintentionally leaving its lane, a vibration motor in the steering wheel warns the driver with a haptic signal (3x pulsation). The system is activated as of a vehicle speed of 60 km/h and indicates that it is ready to operate by means of an inverted or green icon on the instrument cluster. The Lane Keeping Assist system also detects single-sided lane markings.

No warnings are issued when a turn signal is set, on narrow bends, directly after a warning has been issued, for ambiguous markings (yellow/white roadworks markings), during dynamic driving (e.g. heavy acceleration/braking), kickdown or rapid steering. Deliberate corner cutting results in a delayed warning. Earlier warnings are issued on the outside of bends and on narrow lanes.

As of model series 246 and 166, different operating modes can be set on the instrument cluster.

The **Active Lane Keeping Assist** system also intervenes when the vehicle is threatening to cross over continuous lines. If the driver does not respond to the haptic warning in stage 1, the system attempts to keep the vehicle in its lane by performing a single-sided, course-correcting brake system intervention using the ESP.

No intervention is performed by the Active Lane Keeping Assist system if a trailer is coupled, if the ESP is off, in run-flat mode (tires) or if there are single-sided lane markings.

As of model series 207/212 MOPF and 222, the system also performs a course-correcting, single-sided brake system intervention with non-continuous lane markings if there is a risk of collision with vehicles on the adjacent lane due to oncoming traffic, vehicles overtaking rapidly, parallel traffic or stationary vehicles. If a vehicle is detected close behind in the same lane (tailgating scenario) or the system detects an obstacle in the same lane, e.g. cyclists, the course-correcting brake system intervention may be aborted.



Steering wheel with vibration element

1 Vibration motor

P46.10-3366-00

i Service information

The camera has to be re-calibrated if the windshield is replaced, the camera is replaced or the suspension is modified.

Special tool Romess Rogg 0840-10, calibration target for Night View Assist.

System limits

Warnings are only issued if the lane is clearly recognizable. Leaves, snow etc. can conceal the lane and limit the function of the system. Functional impairments can also be caused by the sun shining directly on the camera lens, heavy rain or other visual obstructions e.g. fog. If the vehicle in front is too close, the camera cannot recognize the lane markings because they are concealed by the vehicle in front.

Course-correcting interventions are only performed by the Active Lane Keeping Assist system if the lane markings are continuous and a haptic warning has previously been issued. The maximum change in longitudinal and lateral acceleration is approx. 2 m/s^2 . Furthermore, no interventions are performed on tight bends with a curve radius of $< 150 \text{ m}$. In the case of BR 207/212 MOPF and 222, the system can perform a course-correcting intervention with non-continuous lane markings under certain circumstances (e.g. if there is oncoming traffic in the lane).

The system operates in a vehicle speed range of 60 - 200 km/h. As of a speed of $> 200 \text{ km/h}$, haptic warnings are issued only.

Components

- 1 x multifunction camera
- 1 x vibration motor in steering wheel
- Radar sensors control unit (SGR) (only with Active Lane Keeping Assist)

Additional components as of model series 207/212 MOPF and 222 for recognizing occupied adjacent lanes

- 1 x stereo multifunction camera
- 1 x front long range radar
- 4 x short range radar (2 each at front and rear)
- 1 x rear multi-mode radar

Diagnosis

- Multifunction camera (MFK)
- Radar sensors control unit (SGR)
- Guided calibration via Xentry Diagnostics



P54.33-3401-00

Instrument cluster display

1 Systems vehicle

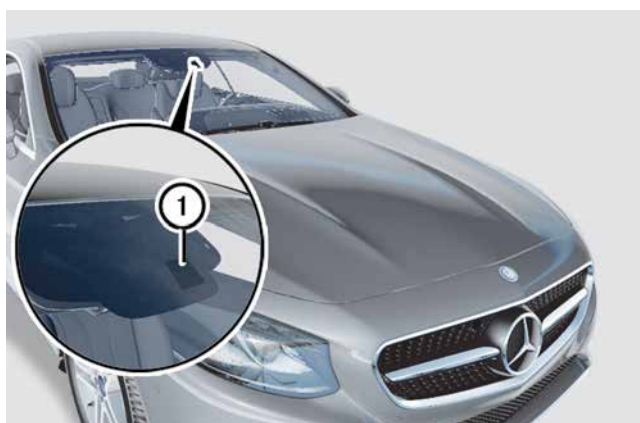

P54.33-3402-00

Installation location of multifunction camera

1 Multifunction camera

DISTRONIC/DISTRONIC PLUS

Features

The DISTRONIC and DISTRONIC PLUS systems from Mercedes-Benz ensure that the systems vehicle maintains a preset time interval to vehicles in front. The radar-assisted adaptive cruise control system maintains a preset speed. If the distance to the vehicle in front reduces, the acceleration is reduced or the system activates the brakes if necessary. As soon as the traffic situation allows it again, the system automatically accelerates back up to the previously set speed.

The time interval can be steplessly adjusted using the cruise control lever in a range of 1 – 2 s. The system brakes and accelerates automatically, but is not able to react to stationary vehicles. The potential braking effect is limited to approx. 30 % of the maximum possible braking power of the vehicle (approx. 40 % with DISTRONIC PLUS and 50 % with DISTRONIC PLUS with Steer Assist). If the braking power which can be applied by the DTR or DTR+ system is not adequate, the driver is warned visually and acoustically. The control response of the DISTRONIC system is determined by the distance to the target object, the vehicle speed and the steering angle.

Additional functions

On vehicles with code 233 as of MY 2011, the system is able to suppress acceleration commands if the target vehicle is lost on freeway exits or traffic circles. The multi-object control function (BR 221/216, 212, 218, 207 with code 233 as of MY 2011) enables the system to respond earlier to vehicles which cut into the lane and to perform situation-dependent braking based on the second vehicle ahead as well as early and dynamic acceleration in the case of lane changes. Here, activation is carried out by actuating the turn signal function.

Additional extended functionality as of BR 207, 212 MOPF and 222

More dynamic acceleration is carried out in the dynamic transmission mode. Braking is carried out with up to approx. 50 % of the max. braking power of the vehicle. The system takes into account the fact that overtaking on the right on freeways or similar roads is not permitted above 80 km/h and adjusts the speed to the traffic line in the left-hand lane. In countries with left-hand traffic, the system prevents overtaking in the left-hand lane.

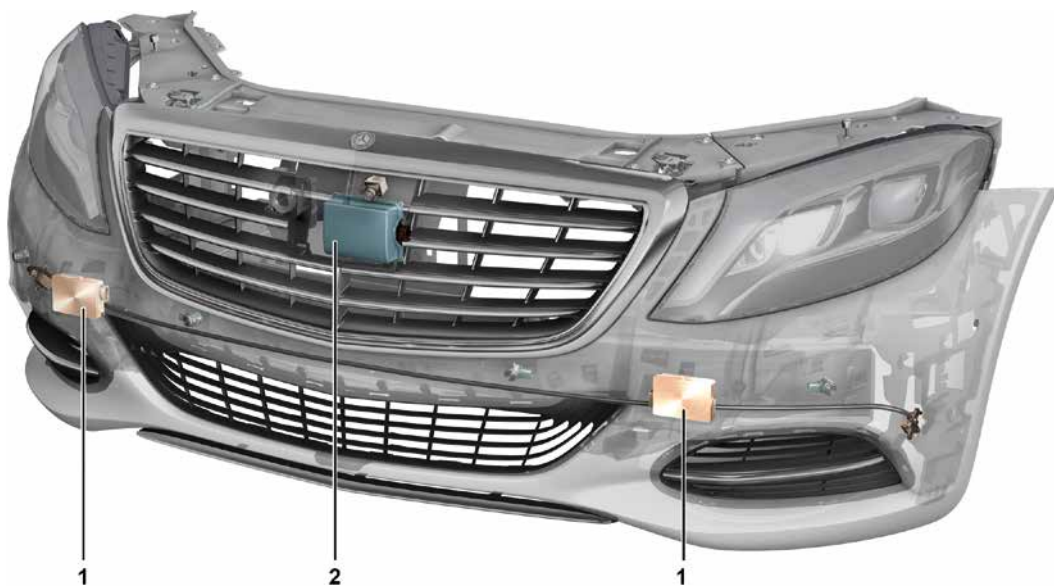

Installation situation of DTR+ radar sensors (code 233)

- 1 Short-range radar sensor
- 2 Long-range radar sensor

P30.30-2660-00

DISTRONIC sensor types: ARS 210 and as of MY 2011 (BR 164/251) ARS 310

Components

- 1 x Long-range radar sensor with integrated control unit

Diagnosis

- DISTRONIC (DTR)



ARS 210 sensor

P30.30-2661-00

DISTRONIC PLUS sensor types: LRR 3 (code 239) and ARS 310/315/316 (code 233)

Components

- 1 x long-range radar sensor with integrated control unit
- 2 x short-range radar (code 233 only)
- 1 x radar sensors control unit (SGR) (code 233 only)

Diagnosis

- DISTRONIC (DTR)
- Radar sensors control unit (SGR) (code 233 only)



Sensor LRR 3

P30.30-2662-00



ARS 310 sensor

P30.30-2663-00

Service information

Manual calibration must be performed on sensor type ARS 210, see AR30.30-P-1000R.

Special tool: Romess Rogg, Order no. 09803

A calibration drive must be performed for sensor type ARS 310/315/316, see Xentry Diagnostics.

Service information

Special tool for sensor type LRR 3:
Beissbarth Order no. 1690380004 or Romess Rogg
Order no. 09807-10

DISTRONIC/DISTRONIC PLUS

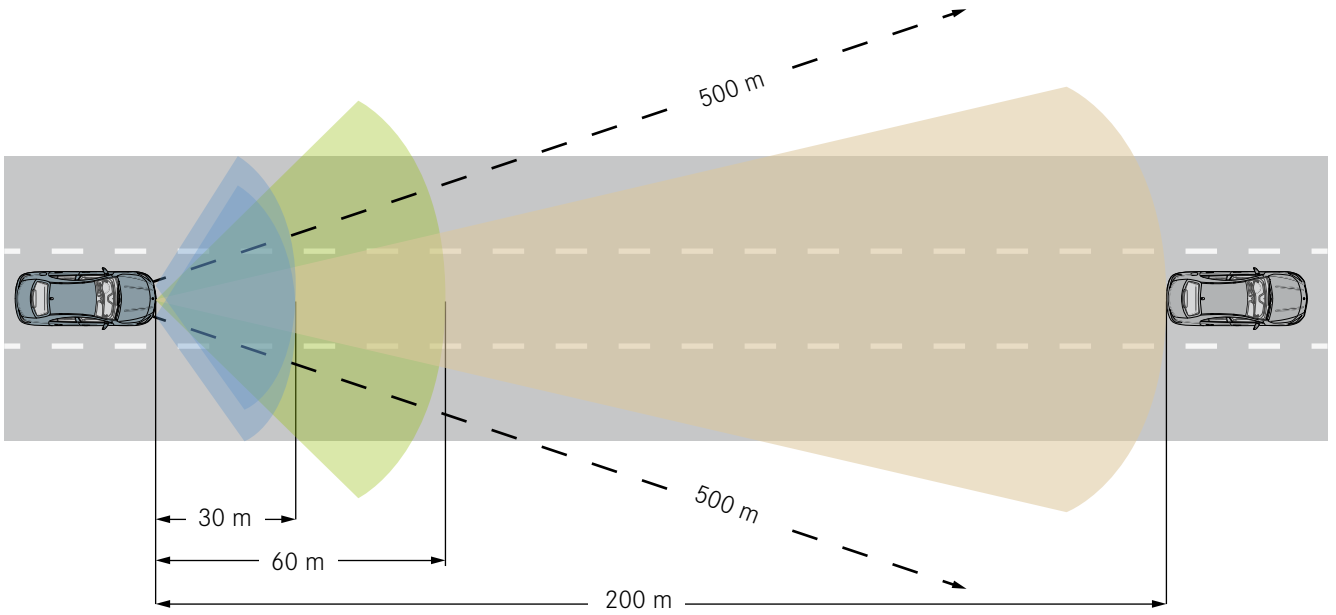

P30.30-2664-00

Detection range of DISTRONIC PLUS with ARS 310 long-range radar sensor and short-range sensors

- Short range with 80° detection angle
 - Medium range with 60° detection angle
- Long range with 18° detection angle
 - Camera range with 35° detection angle

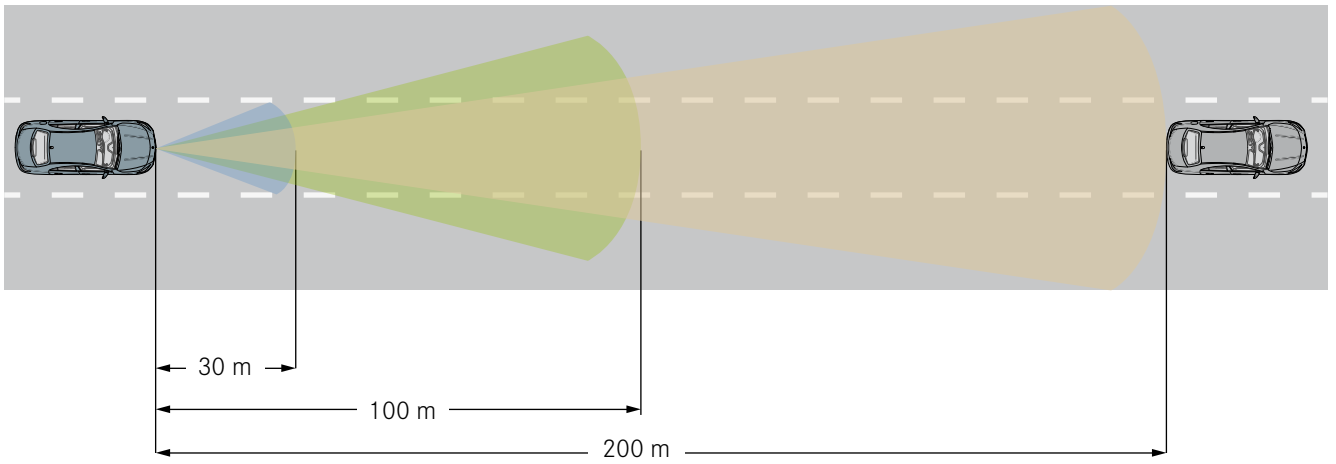

P30.30-2665-00

Detection range of DISTRONIC PLUS with LRR 3 radar sensor

- Short range with 30° detection angle
 - Medium range with 16° detection angle
- Long range with 12° detection angle

System limits

The DTR and DTR+ systems operate in a certain vehicle speed range (see table). Cross-traffic is not detected by the system and the detection of narrow vehicles is not fully reliable. On roads which slope down at the sides, the countersteering changes the sensing angle. Stationary obstacles, e.g. signs on bends, can trigger collision warnings. A further limitation is in the detection of vehicles on bends, whereby brake applications can be performed unexpectedly or with a delay. Furthermore, vehicles driving at an offset may not be detected, which can cause the distance to the vehicle in front to become too short.

In the event of heavy snowfall or icing on the sensor cover in the radiator grille, the system may shut off. This is indicated by the message "System currently unavailable".

In addition, the DTR+ system can shut off in the vicinity of radio astronomy facilities. Manual deactivation may sometimes be necessary here (code 233 only). Similar radar technology in use by other road users or e.g. toll systems, automatic door systems, can also cause the system to shut off.

System	Model series	Sensor	Code	Vehicle speed range	Maximum possible deceleration
DISTRONIC	209, 211, 219, 220, 215, 230	ARS 210	219	30 - 180 km/h	30 %
	164, 251 as of MY 2011	ARS 310	219	0 - 200 km/h	30 %
DISTRONIC PLUS	166, 172, 204 MOPF, 207, 212, 218, 216, 221, 231	ARS 310	233	0 - 200 km/h	40 %
	222,	ARS 315	233	0 - 200 km/h	50 %
	207/212 MOPF	ARS 316	233	0 - 200 km/h	50 %
	117, 176, 246, 463 MOPF	LRR 3	239	0 - 200 km/h	40 %

DISTRONIC PLUS with Steer Assist

Features

The extended functionality of DISTRONIC PLUS with Steer Assist helps the driver to keep the vehicle in the center of the lane on straight roads and minor bends through the application of steering torque in a targeted manner and makes it easier to follow the vehicle in front in traffic jam situations with the "Stop & Go Pilot" function.

The vehicle is kept the center of the lane either by lane or object guidance. The function requirements for lane guidance are a maximum speed of 200 km/h while the stereo multifunction camera is able to detect lane markings on both sides. The lane width must be ≤ 4.2 m and the maximum offset to the center of the lane cannot exceed 40 cm at the start of a control operation. Steering assistance is canceled when the turn signal is actuated. An additional function requirement for object guidance is a vehicle speed of max. 60 km/h while the stereo multifunction camera is able to detect the position of the vehicle in front. The distance to the vehicle in front must be between 1.0 - 40.0 m (speed-dependent) and the offset to the vehicle in front can be max. 0.35 m at the start of a control operation.

The "Stop & Go Pilot" function operates in the range up to 60 km/h. If the lane marking is not detected or missing, the vehicle is kept in the center of the lane through object guidance.

The torque sensor of the electric power steering records the steering torque applied by the driver (hands-off detection) and the signal is evaluated by a control unit. If no steering torque or an insufficient steering torque is measured for approx. 10 s, a visual warning is issued in the first stage. After a further 5 s, an acoustic warning is output in the second stage and the Steer Assist function is deactivated. The DISTRONIC PLUS system still remains active in this case.

System limits

The lane guidance function is aborted if the lane markings cannot be clearly recognized (e.g. due to multiple markings in roadwork zones), if the markings are concealed (snow, leaves etc.), if the contrast to the road surface is too low and in heavy rain or thick fog. The object guidance function is aborted if the vehicle in front changes lane or the distance to passing or parked vehicles is too short. No assistance is provided by the Steer Assist function if a collision with a vehicle in the blind spot is imminent, the driver actively changes lane, the turn signal is operated, the driver does not steer by themselves for an extended period of time or the driver takes his/her hands off the steering wheel.



P54.33-3403-00

Instrument cluster indicator of DISTRONIC PLUS with Steer Assist

1 Steer Assist icon

Components

- 1 x stereo multifunction camera
- 1 x long range radar
- 4 x short range radar (2 each at front and rear)
- Radar sensors control unit (SGR)

Diagnosis

- Stereo multifunction camera (MFK)
- Radar sensors control unit (SGR)

Service information

Guided calibration for multifunction camera and long-range radar with Xentry Diagnostics.

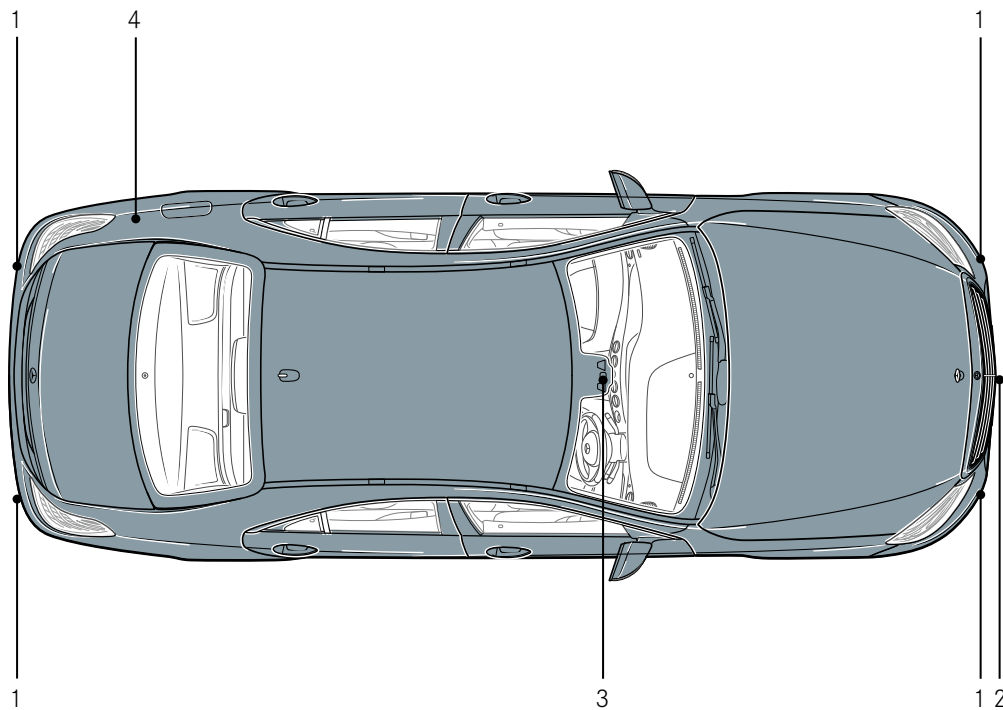

Components of DISTRONIC PLUS with Steer Assist

- | | |
|---------------------|-------------------------------|
| 1 Short range radar | 3 Stereo multifunction camera |
| 2 Long range radar | 4 Radar sensors control unit |

P30.30-2666-00

Night View Assist/Night View Assist PLUS

Features

The Night View Assist and Night View Assist PLUS systems from Mercedes-Benz are infrared light-based camera systems which are used to detect obstacles and hazards at an early stage. The system only works in the dark and if the light switch is set to "On" or "Auto". Special headlamp modules then emit infrared light which is reflected by the surroundings. The reflected infrared light is recorded by the infrared camera and displayed as a grayscale picture. The picture on the display allows the driver to see the path of the road beyond the range of the low beams.

On vehicles with Night View Assist PLUS, an icon at the top right of the picture indicates when pedestrian detection is available on unlit roads. Pedestrians are detected based on their silhouette and a spotlight/warning light function flashes at them three times on the right-hand side of the road with the right-hand high beam. (Only BR 216 MOPF/MY 2012)

Extended functionality as of MY 2014 (BR 222, 231)

The system was extended with a thermal imaging camera which can recognize relevant people at a range of up to 160 m and animals (e.g. deer, cows, horses) up to 100 m ahead of the vehicle. This allows even people or animals without sufficient contrast to be seen. In the dark, the pedestrian detection function is available as of a vehicle speed of 10 km/h. Pedestrian/animal detection is not active when the vehicle is at a standstill. Furthermore, the automatic picture display and spotlight are available on unlit roads as of a vehicle speed of 60 km/h. The automatic picture display function is activated when relevant people or animals are detected.

In contrast to the previous Night View Assist system (BR 221 MOPF, 212, 166), the range of the pedestrian detection function has been increased and it is now also available on illuminated roads. Furthermore, detected people and animals are highlighted more clearly by colored markings. In dark surroundings, the night view picture is automatically activated when objects are detected. The spotlight function is performed by means of a mechanical flap in the headlamp.

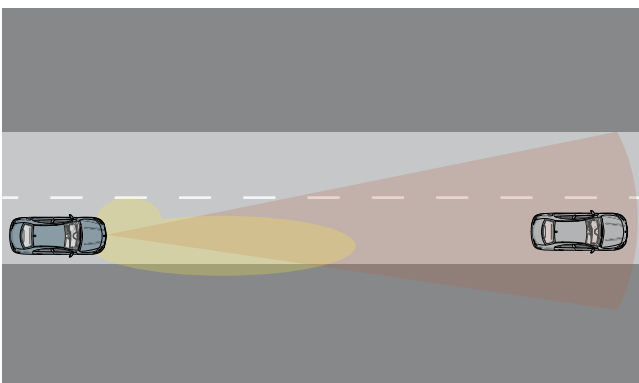

P82.10-7309-00

Viewing range of Night View Assist

- Viewing range with low beams
- Viewing range with Night View Assist

System limits

The infrared illumination function is activated at a vehicle speed of ≥ 10 km/h and it is shut off at a vehicle speed of < 5 km/h. If the windshield is dirty within the camera field of view or in conditions of poor visibility such as snow, rain, fog, sea spray etc., the functionality of the system is limited. The functionality may also be limited on bends and on uphill/downhill slopes.

If people are partially or fully concealed by other objects or if they are not contrasted strongly against the background, the detection capability of the Night View Assist system may be limited. This also applies if people are not standing upright e.g. squatting, sitting or lying down. The function can also be impaired if the silhouette of the person in the display of the Night View Assist PLUS system is incomplete or broken e.g. due to bright light reflections.

On the Night View Assist PLUS system with thermal imaging camera, pedestrian detection may also be impaired if the outside temperature is above 28°C or if insulating objects (rucksacks, functional clothing etc.) hinder the thermal imaging camera's view of objects. Furthermore, the spotlight function does not flash at animals.



P54.33-3404-00

Display on instrument cluster in the dark (pedestrian detection)

- 1 Visual highlighting of person detected by system
- 2 Pedestrian detection active symbol

Night View Assist/Night View Assist PLUS

Components

- 1 x near-infrared camera
- 1 x thermal imaging camera (including cleaning nozzle) (222, 231 as of MY2014)
- 1 x control unit
- 2 x IR headlamp, infrared

Diagnosis

- NV control unit, Night View
- NSA control unit, Night View Assist (222, 231 as of MY2014)

i Service information

The camera has to be re-calibrated if the windshield is replaced, the camera is replaced or the suspension is modified. On systems with thermal imaging camera, the system has to be calibrated if the vehicle suffers significant damage in the area of the radiator grille and after suspension modifications.

Calibration with special tool Romess Rogg 0840-10, calibration target for Night View Assist and calibration device W000589022100.

If the image quality is impaired, the windshield and the camera lens can be cleaned after folding down the cover (see WIS).

The protective glass of the thermal imaging camera can be replaced if it is damaged by stone chipping.



B84/2 Night View Assist infrared camera

P54.33-2595-00

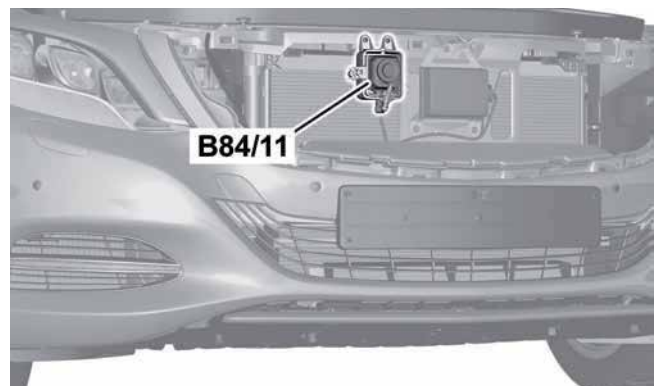

B 84/11 Night View Assist infrared camera (thermal imaging camera)

P54.33-2596-00

Features

The **Adaptive Highbeam Assist** system from Mercedes-Benz automatically adjusts the headlamp range of the low beams to the distance of illuminated vehicles which are in front of or coming towards the systems vehicle. The optimal headlamp range of up to 300 m is thus made available to the driver. A multifunction camera on the inside of the windshield observes the traffic situation in front of the car and helps the driver to see the course of the road, pedestrians or hazards by providing optimal light distribution in every driving situation.

The system is activated by switching the light switch to "Auto" and moving the lever to the high beams position and an indicator on the instrument cluster shows that it is active. The normal high beams symbol indicates when the high beams are active.

Depending on the traffic situation, the high beams are activated and deactivated automatically, which provides added convenience because it is not normally necessary to intervene manually. The multifunction camera detects points of light and evaluates them. If there are vehicles in front or oncoming or if the road lighting is sufficient, the high beams and possibly also the dynamic low beams are dimmed.

The **Adaptive Highbeam Assist PLUS** system makes it possible for the first time to drive with the high beams switched on permanently. The lights are dimmed in the area where other vehicles are located through the actuation of a mechanical flap in the LED headlamp module. This makes nighttime driving even safer.

The system regulates the headlamp range of the low beams dynamically. Reflective glare, e.g. due to reflective traffic signs, is detected and avoided by selective dimming of the headlamps.

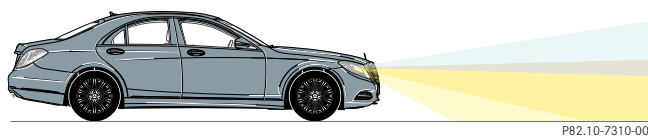

Various light systems

- Low beams
- Dynamic low beams
- No low beams, no high beams (certification: registration not permissible either for low beams or high beams)
- High beams

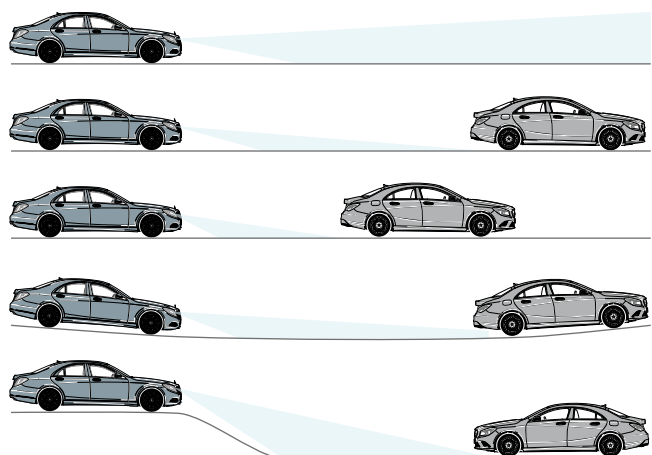

Adaptive Highbeam Assist PLUS

Adaptive Highbeam Assist/Adaptive Highbeam Assist PLUS

System limits

The reflectors of vehicles parked by the side of the road and heavily reflective signs can be mistaken for a vehicle driving front, which can cause the system to dim the headlamps. Individual road lamps and roads where the oncoming traffic is separated by guardrails at headlamp level can also cause the system to dim the headlamps. Vehicles crossing in front and pedestrians are not detected or are detected ineffectively and the system thus does not dim the headlamps.

The Adaptive Highbeam Assist system switches on as of a speed of 55 km/h and switches off at a speed of below 45 km/h. As of 40 km/h, adaptive headlamp range adjustment is performed for the low beams.

The Adaptive Highbeam Assist PLUS system is activated as of 30 km/h in the dark and without road lighting.

Components

- 1 x multifunction camera
- ILS headlamps, Intelligent Light System, with code 622
- LED-ILS headlamps, LED-Intelligent Light System, code 642 (Adaptive Highbeam Assist Plus)

Diagnosis

- Multifunction camera (MFK)

i Service information

The camera has to be re-calibrated if the windshield is replaced, the camera is replaced or the suspension is modified.

Calibration with special tool Romess Rogg 0840-10, calibration target for Night View Assist.

Guided calibration via Xentry Diagnostics.

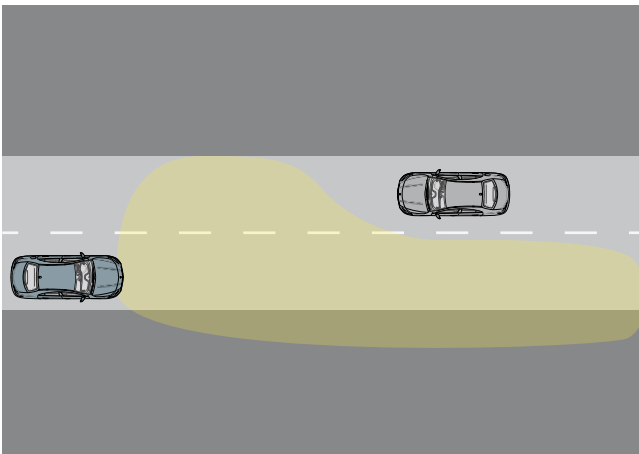

High Beam Assist PLUS with oncoming vehicle

P82.10-7312-00

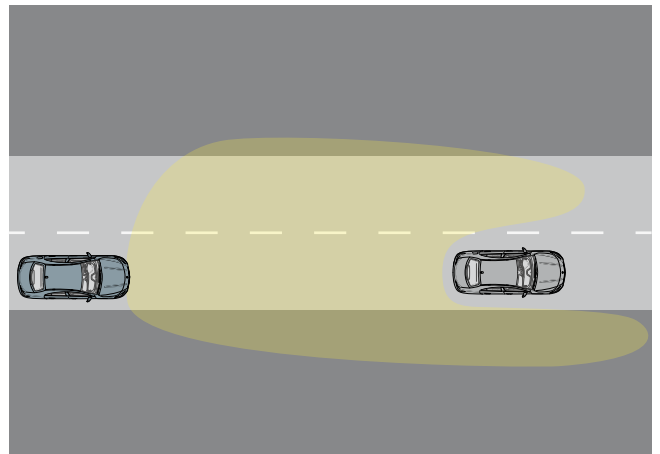

High Beam Assist PLUS with vehicle in front

P82.10-7313-00

Features of cruise control

Cruise control systems from Mercedes-Benz automatically regulate the torque so that the vehicle maintains its set speed. The system automatically brakes, accelerates and shifts gears (with automatic transmission).

There is a non-braking system whereby the vehicle speed is reduced by releasing the accelerator in the vehicle speed range of 40 - 250 km/h. The control interventions are performed by the engine control unit.

On the braking system, the cruise control maintains the set speed between 30 - 250 km/h. The system brakes or shifts down automatically in order to maintain the speed setting.

The cruise control system shuts off automatically if the brake pedal or parking brake is operated or the speed drops below 30 km/h. The system also shuts off as soon as the ESP performs a control intervention or is switched off. On vehicles with manual transmission, the cruise control shuts off automatically if the vehicle is in neutral for longer than 6 s or the clutch is operated. This also happens if a gear which is too high is engaged or the engine speed drops too much. The system is also shut off if the transmission is shifted to the "N" position on vehicles with automatic transmission or if DSR (Downhill Speed Regulation) is switched on on cross-country vehicles. An acoustic warning indicates automatic shutoff, while manual shutoff is not confirmed. The cruise control does not shut off if the driver accelerates.

Speedtronic in combination with (code 440)

The Speedtronic system prevents the vehicle from exceeding a preset speed. The driver is free to choose how he or she wants to accelerate.

The system operates in a vehicle speed range of 30 - 250 km/h. During operation, the system brakes or shifts down automatically so that the speed limit is not exceeded. The limit is either variable or permanent (e.g. winter tire limit).

The Speedtronic system shuts off automatically if the kick-down function is operated (as of model series 117 only switches to "passive"). On vehicles with manual transmission, shutoff is also performed if a gear which is too high is engaged or the engine speed drops too much. Activating "DSR" on cross-country vehicles also causes the system to shut off.

As with the cruise control function, manual shutoff is not confirmed while automatic shutoff is indicated by an acoustic warning.



P54.33-3405-00

Instrument cluster display for cruise control



P54.33-3406-00

Instrument cluster display for Speedtronic

Cruise control and Speedtronic

System limits

Both systems do not take the traffic situation into account and have no distance control functionality.

The cruise control system operates in a vehicle speed range of 30 - 250 km/h. The Speedtronic with variable speed limiter operates in the vehicle speed range of 30 - 250 km/h.

The permanent speed limiter operates in the vehicle speed range of 160 - 240 km/h (e.g. winter tire limit).

Components

- ESP control unit
- Engine control unit
- Steering column tube switch module incl. operating lever

Diagnosis

- ESP control unit
- Engine control unit (non-braking cruise control/variable speed limiter)



P54.33-3407-00

Instrument cluster display for permanent speed limiter

i Service information

The braking cruise control/variable speed limiter is integrated in the ESP. The non-braking cruise control/variable speed limiter is integrated in the engine control unit.

If there is a variation in wheel circumference between the individual wheels of > 4 %, the functions are not available.

Features

The downhill cruise control system maintains the set speed when driving downhill in cross-country vehicles with off-road package. Within certain limits, the vehicle speed can be changed by braking or accelerating at any time. After this, the system returns the vehicle back to the set speed. The steeper the downhill slope, the more powerfully the system brakes. On the flat or on uphill slopes, the system does not brake much or at all. The speed setting is made using the cruise control lever.

System limits

Depending on the type of ground the vehicle is driving on, the system may not be able to maintain the speed exactly. On model series 166 and X 204 MOPF, the speed setting can be adjusted within the range of 2 - 18 km/h. Downhill Speed Regulation can be switched on at vehicle speeds of up to 40 km/h and the system shuts off automatically at speeds above 45 km/h.

On model series X204 before MOPF and 164, the speed setting can be adjusted within the range of 4 - 18 km/h. Downhill Speed Regulation can be switched on at vehicle speeds of up to 30 km/h and the system shuts off automatically at speeds above 35 km/h.

Components

- ESP control unit
- Cruise control lever

Diagnosis

- ESP control unit

Service information

Downhill Speed Regulation is integrated in the ESP.

If there is a variation in wheel circumference between the individual wheels of > 4 %, the function is not available.

Speed Limit Assist/Traffic Sign Assist

Features

The system is able to recognize speed limit markings on round traffic signs. In addition to the image detection by the multifunction camera, the system also performs verification using the map material of the navigation system. The maximum speed indicated on the sign is displayed to the driver on the instrument cluster.

Furthermore, the system is able to reset the display after a minimum distance (country-dependent) without the sign appearing again. This also takes place for end of restriction signs, when the vehicle passes a city limit boundary or when the road type changes e.g. a freeway exit.

System limits

The system is only able to recognize round speed limit signs. Rectangular signs, e.g. for play streets, recommended speeds, or additional signs such as "only when wet" are not recognized. Traffic signs may not be detected or may be detected too late due to rain, fog, direct sunlight on the lens, tailgating or if the field of view of the camera is impaired. Signs on tight bends may be missed.

Irrelevant information, e.g. speed stickers on the rear end of trucks, may be incorrectly recognized as speed limit signs and displayed by the system.



P54.33-2573-00

Instrument cluster display

Extended functionality as of MY 2012

As of MY 2012, Speed Limit Assist 1.5 was introduced. In addition to the maximum speed, this also displays the end of restriction symbol on the multifunction and/or central display. The system also recognizes additional signs and displays them. Speed limits can now also be displayed without traffic signs due to the use of verified map data of the navigation system. The display of irrelevant signs is suppressed (e.g. additional signs only applicable to trucks). As of MY 2012, the extended functionality is additionally available for the following countries: Portugal, Czech Republic, Great Britain, Norway, Poland, Sweden, Latvia, Lithuania, Estonia, Russia, Greece, Slovakia, Hungary, Croatia and Slovenia.

Extended functionality as of 207/212 MOPF and 222

Introduction of Traffic Sign Assist. This additionally recognizes no passing signs - and their associated end of restriction signs - as well as no entry signs. If a no entry sign is detected when the vehicle drives onto a freeway or expressway in the wrong direction (wrong-way driver scenario), the no entry sign is displayed on the instrument cluster and on the Audio/COMAND display. In addition, a warning message is shown on the instrument cluster and an acoustic warning is output.

Components

- 1 x multifunction camera
- 1 x navigation unit

Diagnosis

- MFK control unit

 Service information

The camera has to be re-calibrated if the windshield is replaced, the camera is replaced or the suspension is modified.

Calibration is performed with special tool Romess Rogg 0840-10, calibration target for Night View Assist.

ATTENTION ASSIST

Features

The ATTENTION ASSIST system from Mercedes-Benz analyzes the driver's behavior using sensors and can detect increasing inattentiveness and fatigue based on typical steering patterns and changes in driving style. It supports the driver during long, monotonous journeys, e.g. on freeways and long-distance highways. The system is switched on and off using the assistance systems menu on the instrument cluster and can issue warnings in the vehicle speed range of 80 - 180 km/h.

The system learns the specific steering behavior of the driver during the first 20 min. It evaluates typical signs of fatigue or reduced attentiveness based on the personal driving and steering behavior, time of day and driving time, the operation of vehicle controls and longitudinal/lateral acceleration.

The driver is prompted to take a break through the output of a visual and acoustic warning message. After a break warning, a new warning is issued after another 15 min at the earliest. The system is reset when the engine is switched off or the driver changes, when the seat belt buckle is released and the door is opened.

Extended functionality as of BR 207/212 MOPF and 222

The function of the ATTENTION ASSIST system is active in an extended vehicle speed range of 60 - 200 km/h. In addition, the driver can select three operating modes: "Standard", "Sensitive" and "Off". In "Sensitive" operating mode, the Attention Assist system responds more sensitively and issues warning messages earlier than in "Standard" operating mode. In "Off" operating mode, the output of warnings is suppressed but the system continues to analyze driving behavior.

The attention status of the driver is also shown on the instrument cluster. If the warning threshold is exceeded, the driving time since the last break is displayed in addition to an acoustic warning. Selected rest stop possibilities are also displayed on the Audio/Command display in addition to the warning indication on the instrument cluster. The display of rest stop possibilities can be deactivated on the Audio/Command display.

No warnings or delayed warnings are issued if Steer Assist (code 266) is active.

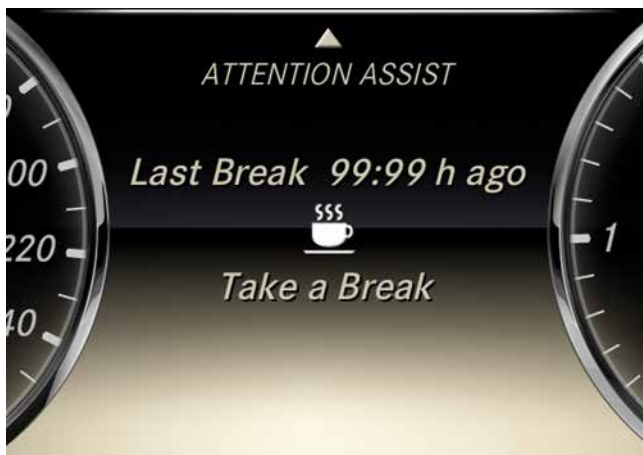

Instrument cluster display for ATTENTION ASSIST

P54.33-3408-00

i Service information

Monitoring and evaluation of the steering wheel angle sensor on the steering column tube is performed by the ESP control unit. In the event of faults in the ESP control unit related to the steering wheel angle sensor, the service instructions must be followed precisely (valid for BR 221 MOPF/216 MOPF).

System limits

The time of day and driving time can affect the sensitivity of the system. Functional impairments and omitted/delayed warnings can occur with a sporty driving style and when driving outside of a vehicle speed range of 80 - 180 km/h or 60 - 200 km/h.

Components

- High-resolution steering wheel angle sensor
- ESP control unit

Diagnosis

- ESP control unit

Even in the active vehicle speed range, the driving behavior cannot be evaluated if certain circumstances occur e.g. frequent lane changes, high cornering speeds, heavy acceleration, frequent operation of audio unit or COMAND controls, very poor road surface condition, e.g. surface undulations, crosswind, short driving periods or if the time is set incorrectly.

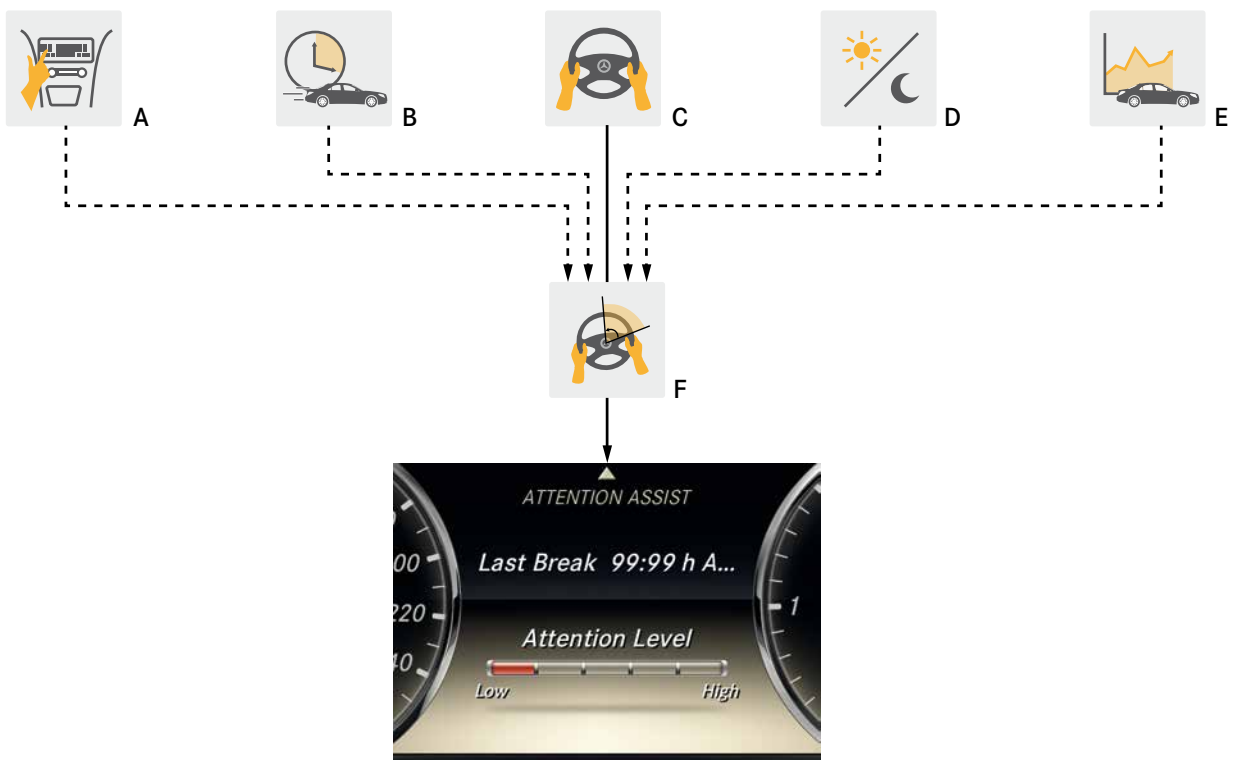

P54.33-3409-00

Schematic illustration of function sequence with display on instrument cluster

- A Operation of controls
- B Driving time
- C Current steering wheel behavior compared to start
- D Time of day
- F Current steering wheel angle
- Part of calculation for fatigue probability using algorithms
- Evaluation

Overview

Parking systems	Abbrevia- tion	SA code	Model series
PARKTRONIC	PTS	220	164/251, 166, 171, 172, 197, 203, 204, 207, 209, 211, 212, 215, 216, 218, 219, 220, 221, 230, 231, 245/169, 246/176, 463
PARKTRONIC with Parking Guidance	APA	230	172, 204 MOPF (not X204), 207, 212, 216 MOPF, 221 MOPF
Active Park Assist	APC	235	117, 166, 169/245 MOPF, 176, X204 MOPF, 207/212 MOPF, 218, 222, 231, 246
Reversing camera	RVC	218	117, 164, 166, 176, 204, 207, 212, 216, 218, 221, 222, 231, 246, 251
360° camera system	SVS	501	X166, W166 as of MY 2013, X204 MOPF, 207/212 MOPF, 222

Features

The PARKTRONIC system from Mercedes-Benz features ultrasonic sensors in the front and rear bumpers. The system uses the echo sounding principle to monitor the surroundings of the vehicle and measures the distance to other vehicles or obstacles during parking maneuvers. As of a distance of approx. 1 - 1.2 m (depending on model series), a visual warning is issued by the system. As of approx. 30 cm, acoustic and visual signals warn the driver about the possibility of a collision.

The system is always active at low vehicle speeds of <16 km/h provided that the ignition is switched on, gear range D, R or N is engaged and the parking brake is released.

The system is deactivated by pressing the "PTS Off" button.

The PARKTRONIC system with Parking Guidance offers additional convenience. This always builds on the functionality of the PARKTRONIC system. If the system detects a parking space of sufficient size, this is indicated by an arrow next to the "P" on the instrument cluster.

Once Parking Guidance is activated, the required steering movements and driving path are indicated. Parking spaces are scanned on the passenger side by default and on the driver side when the turn signal is set.

Steering and driving prompts are displayed after reverse gear is engaged and the parking system is activated. The prerequisite for parking space gaining is a vehicle speed of <35 km/h. The P symbol is displayed as of a vehicle speed of <30 km/h.

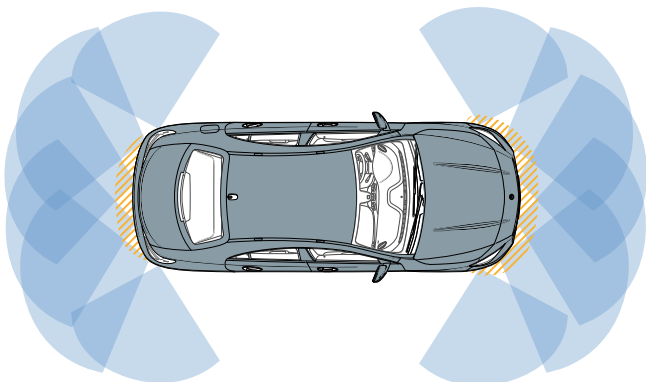

P54.65-5173-00

Location of short range sensors

- Detection range of Park Assist
- Area not scanned

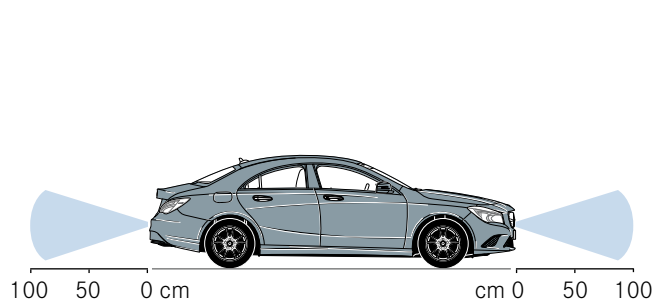

P54.65-5174-00

Range of ultrasonic sensors

- Detection range of ultrasonic sensors

PARKTRONIC/PARKTRONIC with Parking Guidance

System limits

No warning or a delayed warning is issued for objects with a small reflective area, e.g. narrow bars, narrow objects with a surface at an unfavorable angle to the vehicle, objects above or below the sensor detection range or due to snow and other sound-absorbing materials.

System interference can also be caused by the vehicle detection loops used for traffic lights and automatic gates, high grass, sound waves at the same frequency of 50 kHz, e.g. from other Parktronic systems, jackhammers, tramway squeaking noises or the floor echoes that occur in steep underground parking garage entrances. If a trailer is coupled, the system is deactivated at the rear end.

Parking Guidance is only possible for parallel parking and the parking space must have a minimum length equal to the vehicle length + 1.3 m. The system detects all spaces between two vehicles and between vehicles and a clearly recognizable curb. In traffic jams, the system may erroneously indicate parking spaces between vehicles.

Components

- 12 x ultrasonic sensors (8 x on BR 169, 197, 245 before MOPF)
- 1 x control unit
- 1 x front warning element
- 1 x rear warning element

Diagnosis

- PTS control unit

i Service information

The volume and the sound can be adjusted using Xentry Diagnostics. It is also possible to code in an earlier acoustic warning ("extended acoustic warning"). On vehicles equipped with a trailer hitch, this must also be coded in because otherwise it is detected as an obstacle and is not included in distance calculations.

In the case of PARKTRONIC with Parking Guidance, the outer left/right front sensors are special sensors with an extended detection range and separate part numbers.

Features

With the Active Park Assist system from Mercedes-Benz, the vehicle automatically searches for a suitable parking space and then parks the vehicle in it automatically after confirmation by the driver. The driver accelerates and brakes while the Active Park Assist system performs the steering maneuvers automatically. The parking system uses the ultrasonic measuring principle and always incorporates the PARKTRONIC function.

The system scans for parking spaces on both sides. When a suitable parking space is found, an arrow appears next to the "P" on the instrument cluster.

As with PARKTRONIC with parking guidance, parking spaces are scanned on the passenger side by default and on the driver side when the turn signal is set. The parking process starts once reverse gear has been engaged and the Active Park Assist system is activated.

The function requirement is a vehicle speed of <math><10\text{ km/h}</math>. A warning is issued as of a vehicle speed of

System limits

The system only works for parallel parking spaces and not on tight bends or perpendicular parking spaces and does not provide assistance when exiting a parking space. The system also does not perform any automatic brake system interventions and the minimum length of a parking space is: vehicle length + $1.3\text{ m}</math>.$

Steering maneuvers by the Active Park Assist system can be aborted by intervening in the steering maneuver or pressing the "PTS Off" button. Further cancellation conditions include vehicle speeds of $> 10\text{ km/h}</math> or opening the driver seat belt buckle or driver door. EPS faults, e.g. overheating of the steering system, and ESP control interventions also cause the process to abort.$

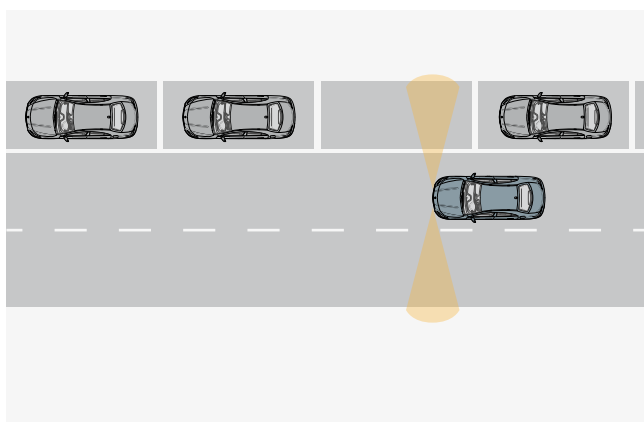

P54.65-5175-00

System detects a suitable parking space

 Ultrasonic sensors with extended range

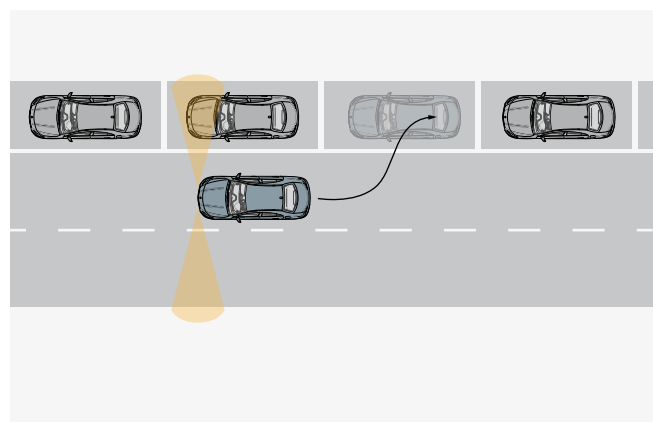

P54.65-5176-00

Semi-automatic parking

 Ultrasonic sensors with extended range

Active Park Assist

Extended functionality on 176, 231, X204 MOPF, 166 as of MY 2013, 246 as of MY 2013

The system was extended with the function of being able to park on bends. Another new feature is parking space exit assistance for parallel parking spaces. It is activated if the vehicle was previously parked in the space using the Park Assist system and the turn signal is set. In this case, the minimum length of the parking space must be: vehicle length +1.0 m.

Extended functionality on BR 117, 207/212 MOPF, 222

With this extended function, the option of parking in perpendicular parking spaces was added. In this case, the width of the parking space must be: vehicle width +1 - 2 m. The vehicle brakes automatically at the necessary maneuvering points and when the final parking position is reached. The vehicle also brakes if the system detects an object or person in the path of the vehicle during the parking maneuver (except BR 117).

Components

- 10 x ultrasonic sensors
- 1 x control unit
- 1 x front warning element
- 1 x rear warning element

Diagnosis

- PTS control unit



Start Park Assist display on instrument cluster

P54.33-3410-00

i Service information

The volume and the sound can be adjusted using Xentry Diagnostics. It is also possible to code in an earlier acoustic warning ("extended acoustic warning"). On vehicles equipped with a trailer hitch, this must also be coded in because otherwise it is detected as an obstacle and is not included in distance calculations.

The outer left/right front sensors are special sensors with an extended detection range and separate part numbers.

Features

The reversing camera (RBC) from Mercedes-Benz switches on automatically when reverse gear or gear range "R" is engaged and displays the area behind the vehicle on the COMAND display. It thus provides a better view of the immediate surroundings at the rear of the vehicle and provides effective assistance for parallel and perpendicular parking.

Different variants are in use depending on the model series. Reversing camera version 1.0 (RVC 1.0) displays only a picture without guide lines on the central display as soon as reverse gear is engaged. The system uses an operating voltage of 5 V and requires an additional modulator (control unit). On certain model series (see table), the COMAND shows static guide lines, or dynamic guide lines in BR 221 before MOPF.

Reversing camera version 2.0 (RVC 2.0) was extended with trailer hitch mode. The picture displays a guide line for the path of the trailer hitch (not with Audio 20) and is equipped with optical and electrical distortion correction. The camera is located centrally, directly on the rear-end door handle and has a special new dirt-resistant coating on the lens. Another new feature is maneuvering mode whereby the camera remains switched on in a forward gear for a defined period of time or defined distance. Static guide lines are replaced by dynamic guide lines on the new version and show the path of the vehicle depending on the steering wheel angle. The PTS indicator is also shown on the COMAND display (not with Audio 20).

In the case of version 3.0 (RVC 3.0), the reversing camera has a direct digital connection to the COMAND and features a 180-degree field of view as well as object recognition.

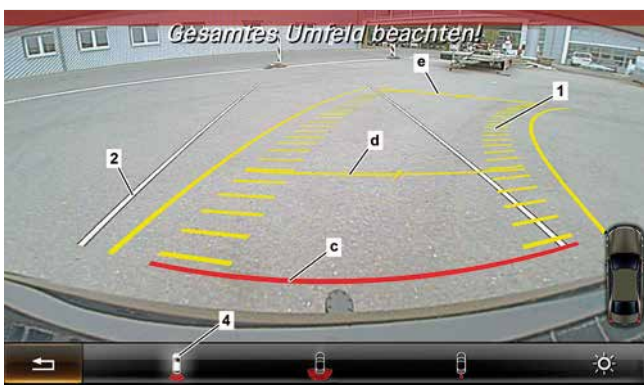

P54.33-3411-00

Display on instrument cluster for maneuvering mode

- 1 Virtual steering angle (dynamic, yellow guide lines)
- 2 Virtual vehicle width (static, white guide lines)
- 4 "Maneuvering mode active" symbol
- c Distance line 0.30 m
- d Distance line 1.0 m
- e Distance line 4.0 m



P54.33-3412-00

Instrument cluster display for trailer mode (with code 550 Trailer hitch)

- 3 Virtual steering angle (yellow guide line)
- 5 "Trailer mode active" symbol
- f Distance line around ball head (red guide line):

Reversing camera

System limits

The camera does not detect any objects outside of the camera viewing cone. The function is limited or not available in the event of direct sunlight, heavy rain, fog or a concealed/dirty lens.

Components

- 1 x camera
- 1 x modulator with RVC 1.0
- 1 x control unit with BR 221 before MOPF

Diagnosis

- RVC control unit

i Service information

The reversing camera with dynamic guide lines has to be calibrated after installation.

Special tool for calibration for RVC 2.0
Order no.: 00058901210 (see Gotis)

Automatic calibration with RVC 2.0 in model 207/212
MOPF, C218 MY 2014 and RVC 3.0



P54.33-3413-00

180° view

6 Parktronic indicator



P54.65-5177-00

Reversing camera on rear-end door handle

Overview of the individual reversing camera systems

Model series	RVC 1.0	RVC 2.0 Dynamic guide lines	RVC 3.0 Dynamic guide lines
C 117		X	
164	X		
164 MOPF	X ¹		
W/X 166		X	
W 176		X	
W/S/C 204 MOPF	X		
X 204	X ¹		
X 204 MOPF		X	
A/C 207	X		
A/C 207 MOPF		X	
W/S/V 212	X		
W/S/V 212 MOPF		X	
C 216 MOPF	X ¹		
C 218	X		
C 218 as of MY14		X	
X 218		X	
W/V 221 MOPF	X ¹		
W/V 222			X
R 231		X	
W 246		X	
251	X		
251 MOPF	X ¹		

¹ Static guide lines

360° camera system

Features

The 360° camera system from Mercedes-Benz receives picture information from four cameras. The picture, which is processed by an image processing system, appears on the COMAND display in real time and displays a bird's eye view of the vehicle and its surroundings. The vehicle corners and sides are monitored with the aim of protecting the outside mirrors and rims. The display of cross-traffic at the front and rear allows the driver to park, maneuver and exit areas safely.

The cameras are positioned in the radiator grille, in the outside mirror housings and in the liftgate handle strip respectively. Based on the four camera images, the steering wheel angle and stored vehicle parameters, the system calculates an artificial picture and displays this bird's eye view of the vehicle and its surroundings (3 m at front/rear and 2.5 m at side) on the Audio/COMAND display with guide lines. The camera viewing angle is up to approx. 180° horizontally and up to approx. 120° vertically.



P54.33-3414-00

View on instrument cluster

- a Distance line 0.30 m
- b Distance line 1.00 m
- c Distance line 4.00 m



P54.33-3415-00

View on instrument cluster

System limits

The side cameras are shut off if the door is opened. Curb edges may be shown in an offset position in the top view due to their height profile.

Components

- 4 x camera
- 1 x 360° camera control unit
- RVC control unit

Diagnosis

- 360° camera system

Service information

After a camera is replaced, it must be calibrated during a calibration drive. If more than one camera is replaced, all cameras have to be calibrated during a calibration drive.

After the control unit is replaced, the calibration values from the old control unit can be transferred to the new control unit using Xentry.



P54.33-3416-00

360° view on instrument cluster

Overview

Driving safety systems	Abbreviation	SA code	Model series
Brake Assist System	BAS	Standard	Standard as of BR 210
Brake Assist System (BAS PLUS)	BAS+	233	166, 172, 204 MOPF, 207, 212, 216, 218, 221, 222, 231 (on vehicles with DISTRONIC PLUS)
Adaptive Brake Assist	-	239/ 252/ 258	117, 176, 246, 242, 207/212 MOPF, 222, 166 (as of MY 2013) (with code 239, 252 or 258)
Brake Assist System PLUS with Intersection Assist	BAS+Q	233 and 269	207/212 MOPF, 222
PRE-SAFE® brake	CMS	233	CMS: 164, 251, 209, 230, 211, 219 CMS and CMS2: 207, 212, 221, 216, 204 MOPF, 166, 218, 231, 172
PRE-SAFE® PLUS	-	253	207/212 MOPF, 222
COLLISION PREVENTION ASSIST	CPA	252/258	Code 252: 246, 176, 166 (as of MY 2013) Code 258: 207/212 MOPF, 222, 117
COLLISION PREVENTION ASSIST PLUS	CPA+	239	117, 176/242/246 as of MY 2014

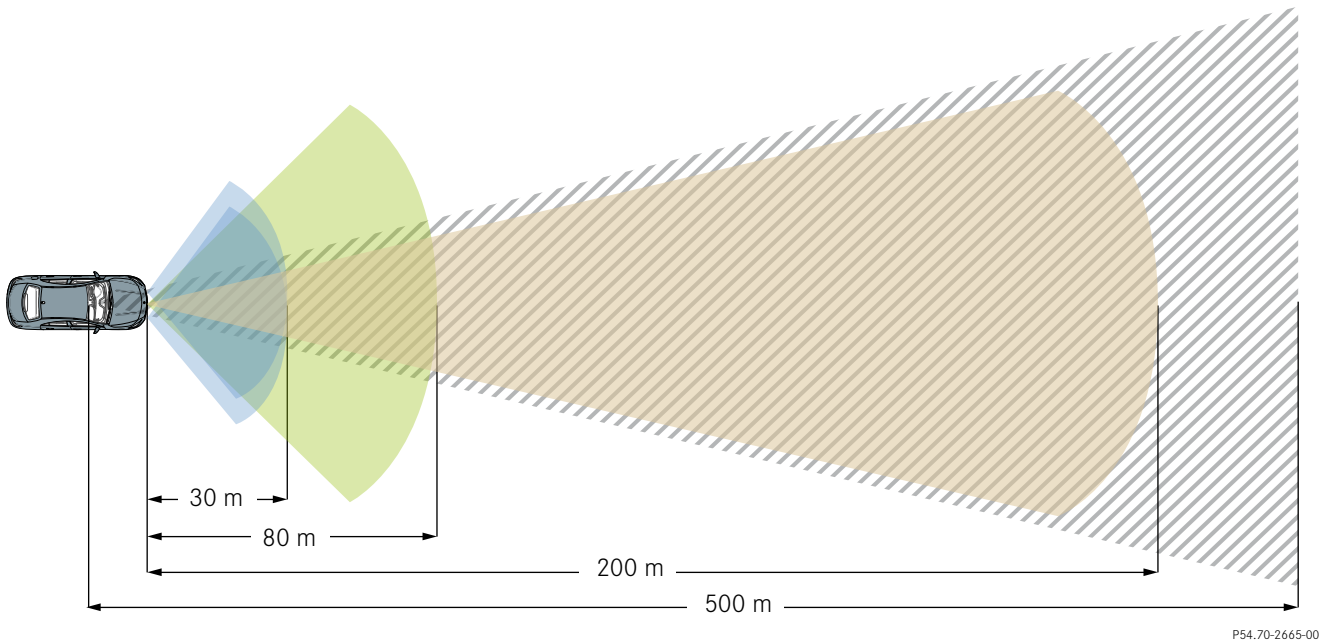

P54.70-2665-00

Detection ranges of radar sensors and stereo multifunction camera

- Detection range of left and right front bumper short-range radar sensor
- Detection range of COLLISION PREVENTION ASSIST
- Detection range of long-range radar sensor
- Detection range of stereo multifunction camera

Features

The Brake Assist System (BAS) from Mercedes-Benz immediately makes the maximum braking force available when the brake pedal is depressed quickly and deliberately. The system thus helps to prevent rear-end collisions or to reduce the impact velocity.

The extended functionality of the BAS PLUS Brake Assist System and Adaptive Brake Assist System provides situation-dependent brake servo assistance with the help of the radar sensor system. The system thus performs optimized and controlled brake applications to fulfill the driver's request, all the way up to emergency braking if necessary.

System limits of BAS PLUS

The system operates in the vehicle speed range of 30 - 250 km/h for moving objects and 30 - 72 km/h for stationary objects.

BAS components

- Diaphragm travel sensor and release switch or
- pressure sensor in the hydraulic unit

BAS PLUS components

- Pressure sensor in the hydraulic unit
- 1 x long range radar
- 2 x short-range radar sensors
- 1 x steering angle sensor
- 1 x radar control unit

Diagnosis

- ESP control unit
- BAS control unit on BR 140, 202, 208, 210
- Radar sensors control unit (SGR) (BAS PLUS)

Service information

See DISTRONIC PLUS

Adaptive Brake Assist

Features

The Adaptive Brake Assist System provides the required brake pressure in critical situations where an accident is impending. It is able to interpret critical situations where an accident is impending using the radar-based systems of COLLISION PREVENTION ASSIST (code 252/258) or COLLISION PREVENTION ASSIST PLUS (as subfunction of DISTRONIC PLUS, code 239).

System limits

See DISTRONIC PLUS or COLLISION PREVENTION ASSIST (PLUS)

Components

- Pressure sensor in the hydraulic unit
- 1 x long range radar (with code 239)
- 1 x mid-range radar (with code 252 or 258)

Diagnosis

- ESP control unit
- DTR (with code 239)
- AWF control unit (with code 252 or 258)

Service information

See DISTRONIC PLUS or COLLISION PREVENTION ASSIST (PLUS)

Features

The BAS PLUS Brake Assist System with Intersection Assist has the same functions as BAS PLUS. In addition, the system also provides the required brake pressure in situations involving cross-traffic where a collision is imminent. It detects cross-traffic using the long-range and short-range radar as well as the stereo multifunction camera.

If the system detects an object in an area which could cause an accident, an acoustic and visual warning is issued by the instrument cluster. The objects which the system can detect include e.g. trucks, cars, motorcyclists/cyclists.

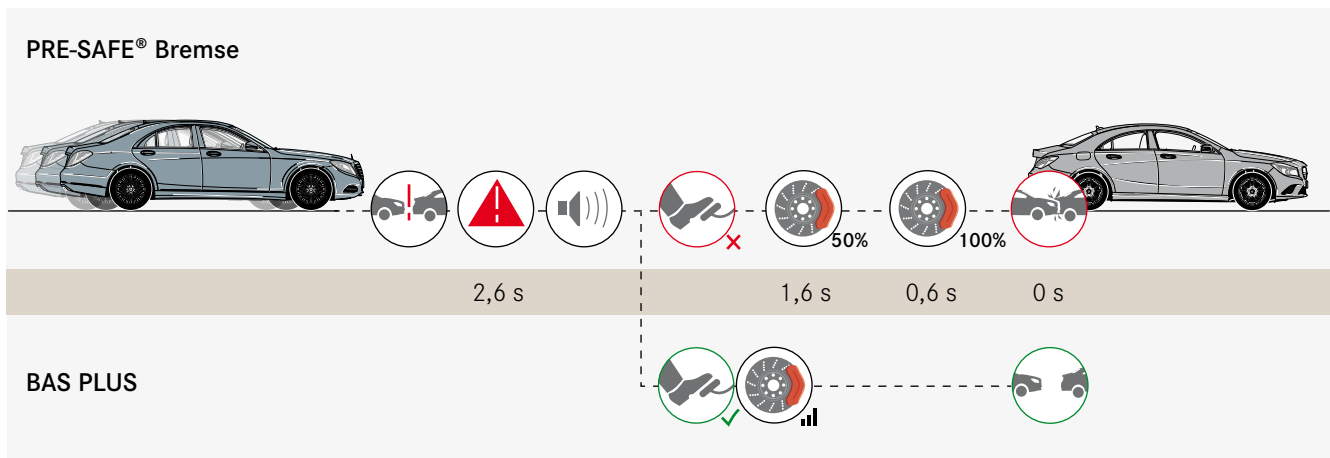

P54_70-2666-00

PRE-SAFE® brake (Collision Mitigation System, CMS) and BAS PLUS in comparison

- Time until collision
- Autonomous brake intervention

Brake Assist System (BAS PLUS) with Intersection Assist

System limits

The BAS PLUS system with Intersection Assist operates in a vehicle speed range of 7 - 250 km/h for moving and stopping objects and up to 72 km/h for stationary and crossing objects.

The system may not be able to detect cross-traffic if approaching objects are concealed by trees, walls, parked vehicles etc. This also applies to objects which approach at high speed or in cases where the radar sensor system shuts off due to heavy snow or icing. This situation can also occur if the windshield is dirty or fogged within the field of view of the stereo multifunction camera.

Components

- Pressure sensor in hydraulic unit
- 1 x long range radar
- 2 x short range radar
- 1 x stereo multifunction camera
- 1 x steering angle sensor
- 1 x radar sensors control unit (SGR)

Diagnosis

- ESP control unit
- Radar sensors control unit (SGR)
- Stereo multifunction camera

Service information

Calibration of stereo multifunction camera using Xentry Diagnostics with special tool from Romess Rogg 0840-10, Calibration target for Night View Assist.

Features

The innovative PRE-SAFE® brake (Collision Mitigation System) from Mercedes-Benz prompts the driver to take action by means of visual and acoustic signals if it detects a risk of a rear-end collision.

To do so, it uses the same sensor system as DISTRONIC PLUS (not code 239). The system is able to perform autonomous braking in order to minimize the consequences of an accident. If the systems vehicle drops below the required minimum distance to the vehicle in front, a visual distance warning is issued for a period of at least 3 s. After this, a collision warning is issued as a first step, which the driver receives approx. 2.6 s before the calculated impact point in the form of a visual and acoustic warning. If the driver does not respond, the system performs partial braking with 40 % of the maximum braking power as a second step, approx. 1.6 s before impact. At the same time, the PRE-SAFE® occupant protection measures are activated. The partial braking can be interrupted by a steering movement, kickdown and/or braking by the driver. If the driver does not intervene, autonomous emergency braking is initiated as a third step, approx. 0.6 seconds before impact (CMS2). In this case, the system is not able to prevent the impact, it can only significantly reduce the severity of the impact.

As of MY 2012, the functional range of the PRE-SAFE® brake system was extended on BR 166, 207, 212, 216, 218, 221, 231. In addition to a downward extension of the vehicle speed range for warnings and interventions, the system can prevent a collision through autonomous emergency braking in the vehicle speed range up to approx. 30 km/h (CMSstop).

Extended functionality on model series 207/212 MOPF, 222

In situations where an accident is imminent, visual and acoustic warnings are issued for longitudinal traffic, cross-traffic and for pedestrians within the path of the vehicle. When pedestrians are detected within the path of the vehicle, autonomous partial or emergency braking is triggered if necessary. Autonomous brake interventions are not performed for cross-traffic. The detection of pedestrians and cross-traffic is carried out using the long-range and short-range radar as well as the stereo multifunction camera. Here, the system detects e.g. trucks, cars, motorcyclists/cyclists and pedestrians.

Service information

Limited availability if radar sensor system dirty.

Service information

Calibration of stereo multifunction camera using Xentry Diagnostics with special tool from Romess Rogg 0840-10, Calibration target for Night View Assist.

PRE-SAFE® brake

System limits

The system provides warnings in a vehicle speed range of 30 – 250 km/h. Autonomous partial/emergency braking is possible in the range of 30 - 200 km/h for moving objects and in the range of 30 - 72 km/h for stationary objects.

As of MY 2012 on model series 166, 207, 212, 216, 218, 221, 231, the PRE-SAFE® brake provides warnings in the vehicle speed range of 7 - 250 km/h. Autonomous partial/emergency braking is possible in the range of 7 - 200 km/h for moving objects and in the range of 7 - 72 km/h for stationary objects.

On vehicles of model series 207/212 MOPF and 222, the system warns in the vehicle speed range of 7 - 250 km/h. Autonomous partial/emergency braking is possible in the range of 7 - 200 km/h for moving and stopping objects and in the range up to 72 km/h for stationary objects.

The system may not be able to detect pedestrians or objects crossing the path of the vehicle if they are concealed at the side by trees, walls, parked vehicles etc. This also applies to objects which approach at high speed or in cases where the radar sensor system shuts off due to heavy snow or icing. This situation can also occur if the windshield is dirty or fogged within the field of view of the stereo multifunction camera.

Components

- 1 x long range radar
- 2 x short range sensors
- 1 x radar sensors control unit (SGR)

Components on BR 207/212 MOPF, 222

- Pressure sensor in hydraulic unit
- 1 x long range radar
- 2 x short range radar
- 1 x stereo multifunction camera
- 1 x steering angle sensor
- 1 x radar sensors control unit (SGR)

Diagnosis

- ESP control unit
- Radar sensors control unit (SGR)
- DTR control unit
- Stereo multifunction camera on BR 207/212 MOPF, 222

Features

PRE-SAFE® PLUS warns following traffic if a rear-end collision is imminent and activates the preventative PRE-SAFE® occupant protection measures in hazardous situations. If the vehicle is at a standstill after a rear-end collision, the risk of injury to occupants can be minimized by keeping the brakes applied to hold the vehicle in place. Here, a multi-mode radar sensor in the rear bumper monitors the traffic behind the vehicle.

If a rear-end collision is imminent, PRE-SAFE® PLUS warns the traffic behind the vehicle approx. 1.4 s before the calculated impact point by actuating the rear hazard warning lamps.

In a second step, the system prepares for the collision if the following conditions are met: The vehicle must be at a standstill and a braking request must be recognized in the form of actuation of the brakes or parking brake or by activation of the "HOLD function" or by engagement of park position "P". In preparing for the collision, the brake pressure is increased in order to hold the vehicle in place. This measure reduces the forward acceleration and minimizes the risk of injury to occupants in the area of their cervical vertebrae.

As the next step, the occupant protection measures are activated approx. 0.1 s before the calculated impact point by the reversible emergency tensioning retractor and NECK-PRO head restraint systems.

After the impact, the brake pressure is maintained for up to approx. 2 s to hold the vehicle in place. The advantages of holding vehicle in place are that it reduces injuries in the area of the cervical vertebrae and it can help to avoid subsequent collisions with other road users.

System limits

The warning for following traffic is issued at a speed differential of up to 72 km/h. On vehicles with code 460 and 494, no warning is issued to following traffic.

Components

- 1 x radar sensors control unit (SGR)
- 1 x multi-mode radar sensor

Diagnosis

- Radar sensors control unit (SGR)
- Multi-mode radar sensor

i Service information

After a rear-end collision has been detected and has taken place, the PRE-SAFE® PLUS function is no longer available until it is activated using a diagnostic tester.

Calibration of the radar sensor is not required.

PRE-SAFE® PLUS

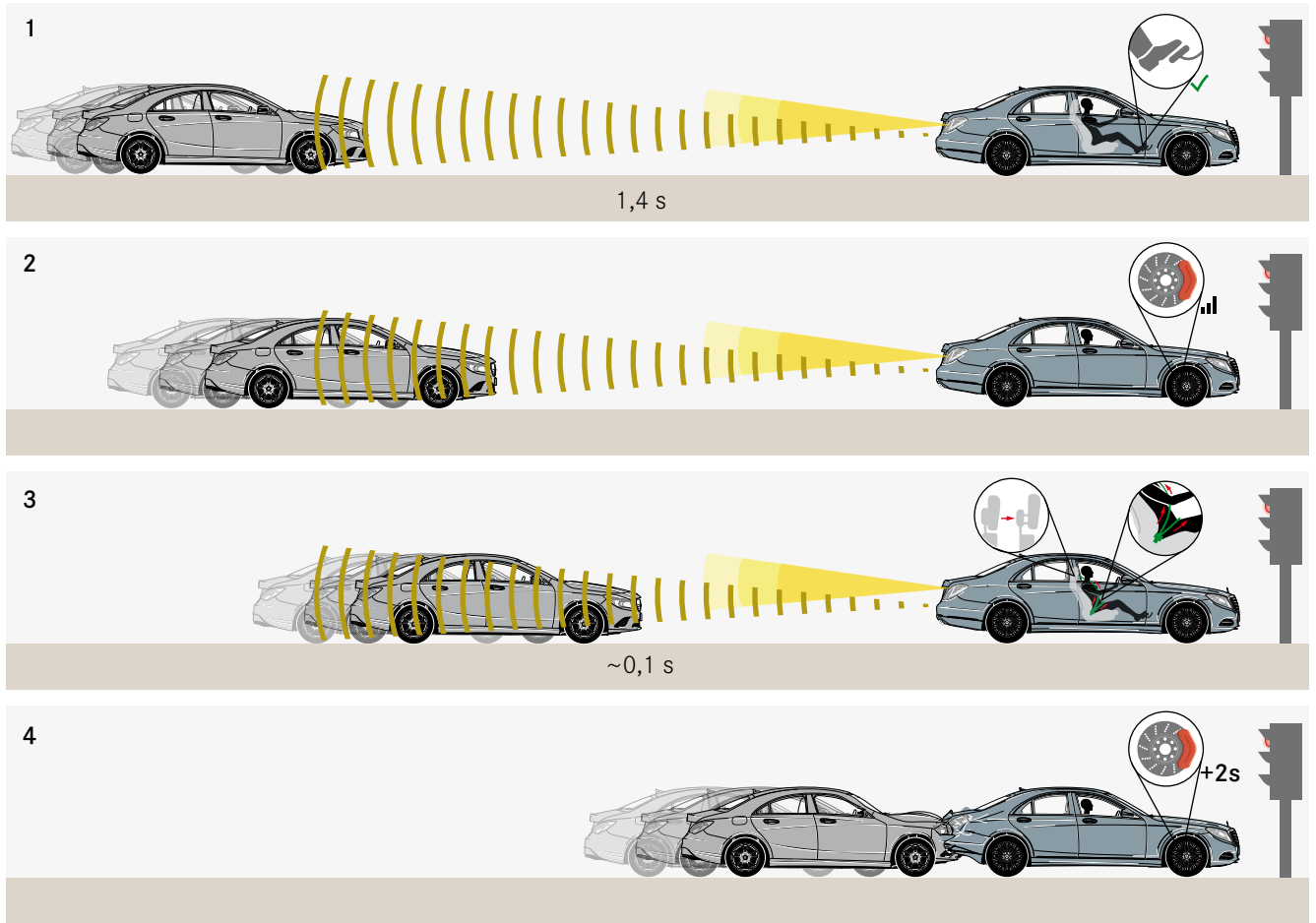

PRE-SAFE® PLUS function

P54.70-2667-00

- Time until collision
- Multi-mode radar sensor
- Hazard warning lamps

Features

The **COLLISION PREVENTION ASSIST** system from Mercedes-Benz provides a visual warning when the distance to the vehicle in front is too short. If the vehicle approaches the vehicle in front at a high relative speed/acceleration, a dynamic distance warning is activated. When the driver brakes, the system works together with the Adaptive Brake Assist System to perform a collision-avoiding, targeted brake application to prevent rear-end collisions in typical driving situations encountered in the city, on country roads and on the freeway. If the system intervention exceeds a critical limit, the PRE-SAFE® functions are also triggered on vehicles which are equipped with them.

In addition to issuing a visual and acoustic warning in the event of an imminent collision, the **COLLISION PREVENTION ASSIST PLUS** system also performs autonomous partial braking with up to 60 % of the max. braking power of the vehicle. The system uses the same sensor system as DISTRONIC PLUS (code 239).

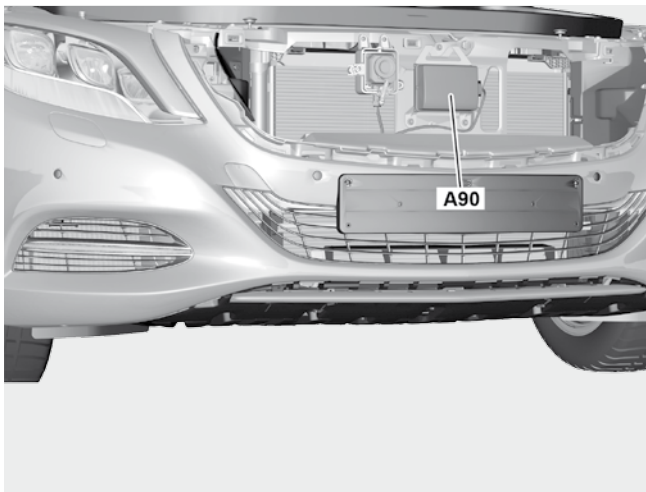

P54.70-2668-00

COLLISION PREVENTION ASSIST

A90 COLLISION PREVENTION ASSIST controller unit

COLLISION PREVENTION ASSIST/ COLLISION PREVENTION ASSIST PLUS

System limits

On vehicles with code 252, the warning functions operate in a vehicle speed range of 30 - 250 km/h for moving and stopping objects and between 30 - 72 km/h for stationary objects.

For vehicles with code 258 and for COLLISION PREVENTION ASSIST PLUS, the applicable ranges are 7 - 250 km/h for moving and stopping objects and 7 - 72 km/h for stationary objects.

On vehicles with code 252, the Adaptive Brake Assist System is active in a vehicle speed range of 30 - 250 km/h for moving and stopping objects.

For vehicles with code 258 and COLLISION PREVENTION ASSIST PLUS, the applicable ranges are 7 - 250 km/h for moving and stopping objects and for COLLISION PREVENTION ASSIST PLUS they are 7 - 30 km/h for stationary objects.

The COLLISION PREVENTION ASSIST PLUS system can perform autonomous partial braking at vehicle speed ranges of 7 - 200 km/h for moving and stopping objects and 7 - 30 km/h for stationary objects.

Components

- 1 x mid-range radar (MRR) (code 252, 258)
- 1 x long-range radar with integrated control unit (Plus) (sensor type LRR 3)

Diagnosis

- AWF control unit (code 252, 258)
- DTR-Distronic (Plus)

Service information

Calibration as per DISTRONIC PLUS (code 239) for COLLISION PREVENTION ASSIST PLUS.

Product Portfolio

Comprehensive information about our complete product portfolio can also be found on our Internet portal:

Link: <http://aftersales.mercedes-benz.com>

Questions and Suggestions

If you have any questions or suggestions concerning this product, please write to us.

E-mail: customer.support@daimler.com

Telephone: +49 (0) 69-95 30 73 76

© 2013 by Daimler AG

This document, including all its parts, is protected by copyright. Any further processing or use requires the previous written consent of Daimler AG, Department GSP/OR, D-70546 Stuttgart. This applies in particular to reproduction, distribution, alteration, translation, microfilming and storage and/or processing in electronic systems, including databases and online services.

Image no. of title image: P54.33-3433-00

Order no. of this publication: HLI 000 000 15 12

Space for your notes

