

**Transmission 725.0**  
as of model year 2015

**Shown on transmission 725.004**

- 1 Quick-release coupling

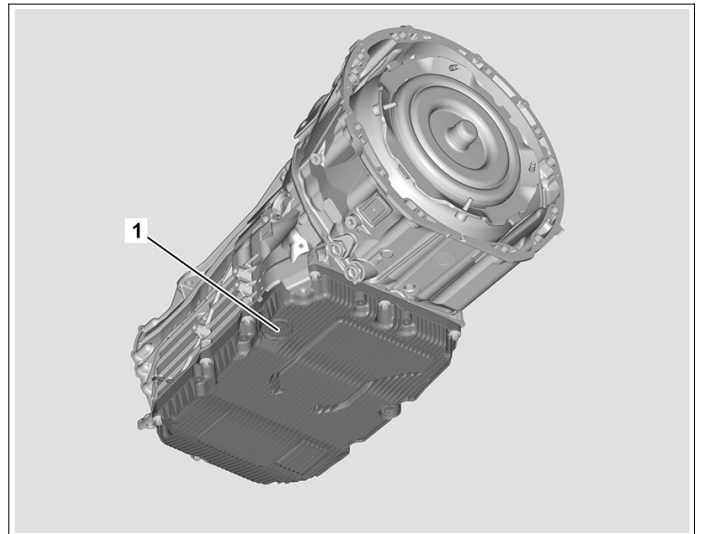

P27.00-2454-11



**Shown on transmission 725.007**

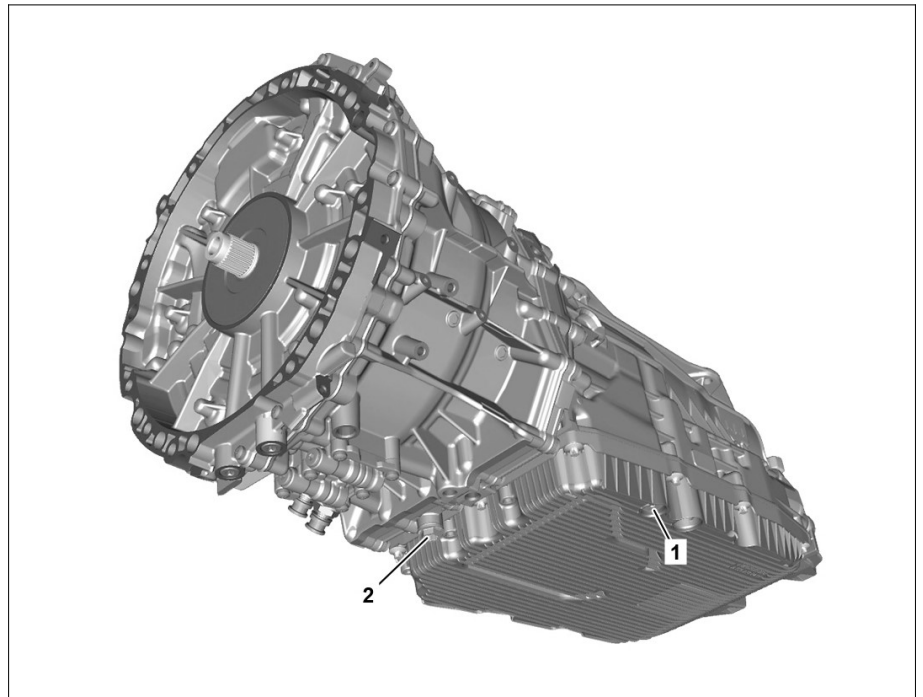





- 1 Quick-release coupling  
2 Thermostat screw plug



























P27.00-2506-06

⚠ Caution	<b>Risk of injury</b> caused by scraping or cutting body parts on sharp vehicle parts	Always wear protective gloves when working on or near sharp and non-deburred vehicle parts. Deburr repair panels.	AS00.00-Z-0017-01A
⚠ Warning	<b>Risk of injury.</b> Skin or eye injuries may result when handling hot or glowing objects.	Wear protective gloves, protective clothing and safety glasses, if necessary.	AS00.00-Z-0002-01A
	<b>Risk of death</b> caused by vehicle slipping or toppling off of the lifting platform.	Align vehicle between vehicle lift columns and position the four support plates at the vehicle lift support points specified by the vehicle manufacturer.	AS00.00-Z-0010-01A
⚠ Caution	<b>Risk of injury</b> to skin and eyes due to handling of transmission oil. Health risk caused by swallowing transmission oil	Wear protective gloves, protective clothing and safety glasses. Do not pour transmission oil into beverage bottles.	AS00.40-Z-0001-01A
⚠ Warning	<b>Risk of accident</b> from vehicle starting off by itself when engine running. <b>Risk of injury</b> (bruises and burns) resulting from working on the engine while it is being started or when it is running.	Secure vehicle to prevent it from starting off by itself. Wear closed and snug-fitting work clothes. Do not touch hot or rotating parts.	AS00.00-Z-0005-01A

	Notes on automatic transmission		AH27.19-P-0001-01NKB
	<b>Fill with transmission oil</b>		
1	Shift transmission to neutral position and secure vehicle against rolling away.		
2	Lift vehicle with lifting platform.	<p>Transmission 725.0 in model 463 as of model year 2019</p> <p>Transmission 725.0 in model 257 as of model year 2015</p> <p>Transmission 725.0 in model 205, 213, 238, 253 as of model year 2015</p> <p>Transmission 725.0 in model 172 as of model year 2015</p> <p>Transmission 725.0 in model 166, 292 as of model year 2015</p> <p>Transmission 725.0 in model 231 as of model year 2015</p> <p>Transmission 725.0 in model 217, 222 as of model year 2015</p> <p>Transmission 725.0 in model 207 as of model year 2015</p> <p>Transmission 725.0 in model 212, 218 as of model year 2015</p> <p> Ensure that vehicle is level in longitudinal and transverse direction on vehicle lift.</p> <p> Transmission 725.0 in model 463 as of model year 2018 Adapter</p>	<p>AR00.60-P-1005-01XG</p> <p>AR00.60-P-1005-02FR</p> <p>AR00.60-P-1002LWG</p> <p>AR00.60-P-1000V</p> <p>AR00.60-P-1000GZ</p> <p>AR00.60-P-1000TX</p> <p>AR00.60-P-1000LF</p> <p>AR00.60-P-0100CW</p> <p>AR00.60-P-0100EWS</p> <p>*463589023100</p>
3	Remove trim under transmission.	<p>Transmission 725.0 in model 463 as of model year 2019</p> <p>Transmission 725.0 in model 257 as of model year 2015</p> <p>Transmission 725.0 in model 172.4 with engine 651 as of model year 2015</p> <p>Transmission 725.0 in model 207, 212, 218 with engine 642 as of model year 2015</p> <p>Transmission 725.0 in model 207, 212, 218 with engine 651 as of model year 2015</p> <p>Transmission 725.0 in model 172.4 with engine 274 as of model year 2015</p> <p>Transmission 725.0 in model 172.4 with engine 276 as of model year 2015</p> <p>Transmission 725.0 in model 205, 253 with engine 177 as of model year 2015</p> <p>Transmission 725.0 in model 205, 253 with engine 274 as of model year 2015</p> <p>Transmission 725.0 in model 205, 253 with engine 276 as of model year 2015</p> <p>Transmission 725.0 in model 205, 253 with engine 651 as of model year 2015</p> <p>Transmission 725.0 in model 253 with engine 642 as of model year 2015</p> <p>Transmission 725.0 in model 231 with engine 276 as of model year 2015</p> <p>Transmission 725.0 in model 231 with engine 278 as of model year 2015</p>	<p>AR61.20-P-1105XG</p> <p>AR61.20-P-1105FR</p> <p>AR94.30-P-5300W</p> <p>AR94.30-P-5300EW</p> <p>AR61.20-P-1105W</p> <p>AR61.20-P-1105LW</p> <p>AR61.20-P-1105RK</p>

		<p>Transmission 725.0 in model 213 with engine 177 as of model year 2015</p> <p>Transmission 725.0 in model 213 with engine 642 as of model year 2015</p> <p>Transmission 725.0 in model 213, 238 with engine 274 as of model year 2015</p> <p>Transmission 725.0 in model 213, 238 with engine 276 as of model year 2015</p> <p>Transmission 725.0 in model 213, 238 with engine 654 as of model year 2015</p> <p>Transmission 725.0 in model 217, 222 with engine 176 as of model year 2015</p> <p>Transmission 725.0 in model 217, 222 with engine 177 as of model year 2015</p> <p>Transmission 725.0 in model 217, 222 with engine 278 as of model year 2015</p> <p>Transmission 725.0 in model 222 with engine 256 as of model year 2015</p> <p>Transmission 725.0 in model 222 with engine 276 as of model year 2015</p> <p>Transmission 725.0 in model 222 with engine 642 as of model year 2015</p> <p>Transmission 725.0 in model 222 with engine 656 as of model year 2015</p> <p>Transmission 725.0 in model 218 with engine 276 as of model year 2015</p> <p>Transmission 725.0 in model 218 with engine 278 as of model year 2015</p> <p>Transmission 725.0 in model 166 with engine 651 as of model year 2015</p> <p>Transmission 725.0 in model 166, 292 with engine 276 as of model year 2015</p> <p>Transmission 725.0 in model 166, 292 with engine 278 as of model year 2015</p> <p>Transmission 725.0 in model 166, 292 with engine 642 as of model year 2015</p>	<p>AR61.20-P-1105LWE</p> <p>AR61.20-P-1105LF</p> <p>AR61.20-P-1105EW</p> <p>AR61.30-P-1001GQ</p>
4	Position suitable oil receptacle under thermostat screw plug (2).		
5	Unscrew thermostat screw plug (2) with spring and thermostat element.	<p>Transmission 725.007/017/033/047 as of model year 2015</p> <p> The thermostat element is under spring preload.</p>	
6	Screw adapter with sealing ring into opening for thermostat element.	<p>Transmission 725.007/017/033/047 as of model year 2015</p> <p> Adapter</p>	*724589002100
7	Position suitable oil receptacle under quick-release fastener (1) of oil pan.		
8	Unscrew quick-release fastener (1).	 Socket wrench	*724589010900
9	<p> WS</p> <p>Attach adapter and connect oil dispenser. 000 588 06 82 00 Oil dispenser</p>	<p> Adjust air pressure at oil dispenser to 2 bar at the highest before filling transmission. Otherwise the oil pan may be damaged.</p> <p> Transmission 725.007/017/033/047 as of model year 2015 Adapter</p> <p> Transmission 725.0 (except 725.007/017/033/047) as of model year 2015 Adapter</p>	<p>WS18.00-P-0026B</p> <p>*725589039000</p> <p>*725589009000</p>
10	Pump transmission oil into transmission.		

 <b>BB</b>	Automatic transmission fluids (ATF) (specification 236.17)	 If transmission oil was drained off, pour in the amount drained off + approx. 0.5 l of transmission oil. If no transmission oil was drained off, pump approx. 0.5 l of transmission oil into transmission.   Filling capacity	<b>BB00.40-P-0236-17A</b>  *BF27.00-P-1001-011
11   <b>WS</b>	Disconnect adapter and screw in oil dispenser and quick-release fastener (1). 000 588 06 82 00 Oil dispenser	 Transmission 725.007/017/033/047 as of model year 2015 Adapter  Transmission 725.0 (except 725.007/017/033/047) as of model year 2015 Adapter	<b>WS18.00-P-0026B</b> *725589039000  *725589009000
12.1   <b>AD</b>   <b>AD</b>   <b>AD</b>   <b>AD</b>   <b>WS</b>  <b>WS</b>  <b>BB</b>	Start test routine, check transmission oil level and correct if necessary.           000 588 09 19 00 Oil level sensor 000 588 06 82 00 Oil dispenser Automatic transmission fluids (ATF) (specification 236.17)	When using an oil level sensor.  Transmission 725.0 in model 257 as of model year 2015 Transmission 725.0 in model 205, 213, 217, 222, 253 as of model year 2015 Transmission 725.0 in model 463 as of model year 2019 Transmission 725.0 in model 166, 172, 207, 212, 218, 231, 292 as of model year 2015 Transmission 725.0 in model 238 as of model year 2015  MB Plastilube brake paste (brownish)  Socket wrench  Transmission 725.0 (except 725.007/017/033/047) as of model year 2015 Adapter  Transmission 725.007/017/033/047 as of model year 2015 Adapter  Socket wrench	<b>AR27.00-P-0270-02EWN</b> <b>AD00.00-P-2000-06FR</b>  <b>AD00.00-P-2000-04B</b>  <b>AD00.00-P-2000-04A</b>  <b>AD00.00-P-2000-06LWO</b>  <b>WS27.00-P-0188B</b> <b>WS18.00-P-0026B</b> <b>BB00.40-P-0236-17A</b>  *BR00.45-Z-1084-06A *725589000900 *725589009000  *725589039000  *724589010900
12.2   <b>AD</b>   <b>AD</b>   <b>AD</b>   <b>AD</b>	Start test routine, check transmission oil level and correct if necessary.	When not using an oil level sensor.  Transmission 725.0 in model 257 as of model year 2015 Transmission 725.0 in model 238 as of model year 2015 Transmission 725.0 in model 166, 172, 207, 212, 218, 231, 292 as of model year 2015 Transmission 725.0 in model 205, 213, 217, 222, 253 as of model year 2015 Transmission 725.0 in model 463 as of model year 2019  Socket wrench  Socket wrench	<b>AR27.00-P-0270-03EWN</b> <b>AD00.00-P-2000-06FR</b>  <b>AD00.00-P-2000-06LWO</b>  <b>AD00.00-P-2000-04A</b>  <b>AD00.00-P-2000-04B</b>  *725589000900 *724589010900
13	Remove adapter with sealing ring from opening for thermostat element.	Transmission 725.007/017/033/047 as of model year 2015  Adapter	*724589002100
14	Screw in thermostat screw plug (2) with spring and thermostat element.	Transmission 725.007/017/033/047 as of model year 2015	
15	Install trim under transmission.	Transmission 725.0 in model 463 as of model year 2019 Transmission 725.0 in model 257 as of model year 2015 Transmission 725.0 in model 172.4 with engine 651 as of model year 2015	<b>AR61.20-P-1105XG</b>  <b>AR61.20-P-1105FR</b>  <b>AR94.30-P-5300W</b>

Transmission 725.0 in model 207, 212, 218 with engine 642 as of model year 2015	AR94.30-P-5300EW
Transmission 725.0 in model 207, 212, 218 with engine 651 as of model year 2015	
Transmission 725.0 in model 172.4 with engine 274 as of model year 2015	AR61.20-P-1105W
Transmission 725.0 in model 172.4 with engine 276 as of model year 2015	
Transmission 725.0 in model 205, 253 with engine 177 as of model year 2015	AR61.20-P-1105LW
Transmission 725.0 in model 205, 253 with engine 274 as of model year 2015	
Transmission 725.0 in model 205, 253 with engine 276 as of model year 2015	
Transmission 725.0 in model 205, 253 with engine 651 as of model year 2015	
Transmission 725.0 in model 253 with engine 642 as of model year 2015	
Transmission 725.0 in model 231 with engine 276 as of model year 2015	AR61.20-P-1105RK
Transmission 725.0 in model 231 with engine 278 as of model year 2015	
Transmission 725.0 in model 213 with engine 177 as of model year 2015	AR61.20-P-1105LWE
Transmission 725.0 in model 213 with engine 642 as of model year 2015	
Transmission 725.0 in model 213, 238 with engine 274 as of model year 2015	
Transmission 725.0 in model 213, 238 with engine 276 as of model year 2015	
Transmission 725.0 in model 213, 238 with engine 654 as of model year 2015	
Transmission 725.0 in model 217, 222 with engine 176 as of model year 2015	AR61.20-P-1105LF
Transmission 725.0 in model 217, 222 with engine 177 as of model year 2015	
Transmission 725.0 in model 217, 222 with engine 278 as of model year 2015	
Transmission 725.0 in model 222 with engine 256 as of model year 2015	
Transmission 725.0 in model 222 with engine 276 as of model year 2015	
Transmission 725.0 in model 222 with engine 642 as of model year 2015	
Transmission 725.0 in model 222 with engine 656 as of model year 2015	
Transmission 725.0 in model 218 with engine 276 as of model year 2015	AR61.20-P-1105EW
Transmission 725.0 in model 218 with engine 278 as of model year 2015	

		Transmission 725.0 in model 166 with engine 651 as of model year 2015 Transmission 725.0 in model 166, 292 with engine 276 as of model year 2015 Transmission 725.0 in model 166, 292 with engine 278 as of model year 2015 Transmission 725.0 in model 166, 292 with engine 642 as of model year 2015	AR61.30-P-1001GQ
16	Lower the vehicle from the vehicle lift.	Transmission 725.0 in model 463 as of model year 2019 Transmission 725.0 in model 257 as of model year 2015 Transmission 725.0 in model 205, 213, 238, 253 as of model year 2015 Transmission 725.0 in model 166, 292 as of model year 2015 Transmission 725.0 in model 172 as of model year 2015 Transmission 725.0 in model 231 as of model year 2015 Transmission 725.0 in model 217, 222 as of model year 2015 Transmission 725.0 in model 207 as of model year 2015 Transmission 725.0 in model 212, 218 as of model year 2015 <input checked="" type="checkbox"/> Transmission 725.0 in model 463 as of model year 2018 Adapter	AR00.60-P-1005-01XG AR00.60-P-1005-02FR AR00.60-P-1002LWG AR00.60-P-1000GZ AR00.60-P-1000V AR00.60-P-1000TX AR00.60-P-1000LF AR00.60-P-0100CW AR00.60-P-0100EWS *463589023100

 Automatic transmission

Number	Designation	Transmission 725.0 (except 725.007/017/033/047)	Transmission 725.007/017/033/047
BF27.00-P-1001-01I	Filling capacity	with complete refill Liter ≈ 10 Specifications for Operating Fluids, sheet	≈ 11 BB00.40-P-0236-17A BB00.40-P-0236-17A

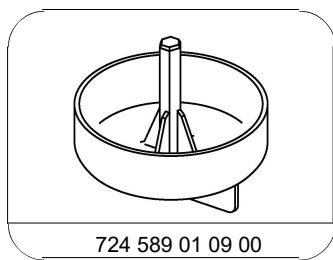

724 589 01 09 00

Socket wrench

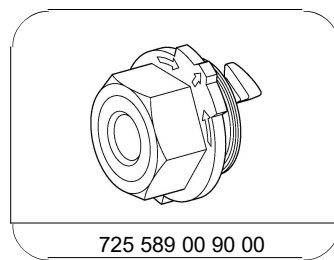

725 589 00 90 00

Adapter

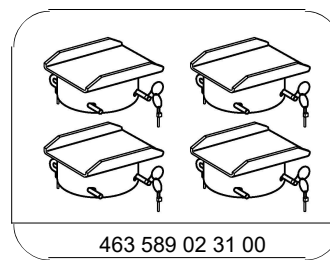

463 589 02 31 00

Adapter

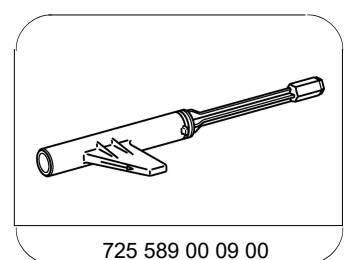

725 589 00 09 00

Socket wrench

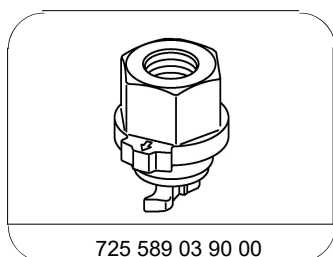

725 589 03 90 00

Adapter

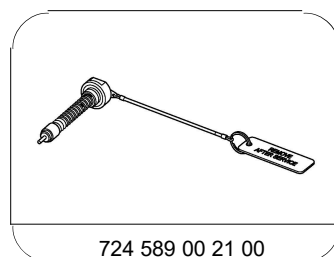

724 589 00 21 00

Adapter

Repair materials

<b>Number</b>	<b>Designation</b>	<b>Order number</b>
BR00.45-Z-1084-06A	MB Plastilube brake paste (brownish)	A 002 989 37 51