

Model 217

Modification notes

14.07.2017	Operation step variant modified.	Operation steps 1.1 and 1.2.
------------	----------------------------------	------------------------------

Shown on model 217 up to model year 2018

- 1 Mercedes star
- 2 Radiator trim
- 3 Mercedes star
- 4 Front bumper
- 5 Grommets

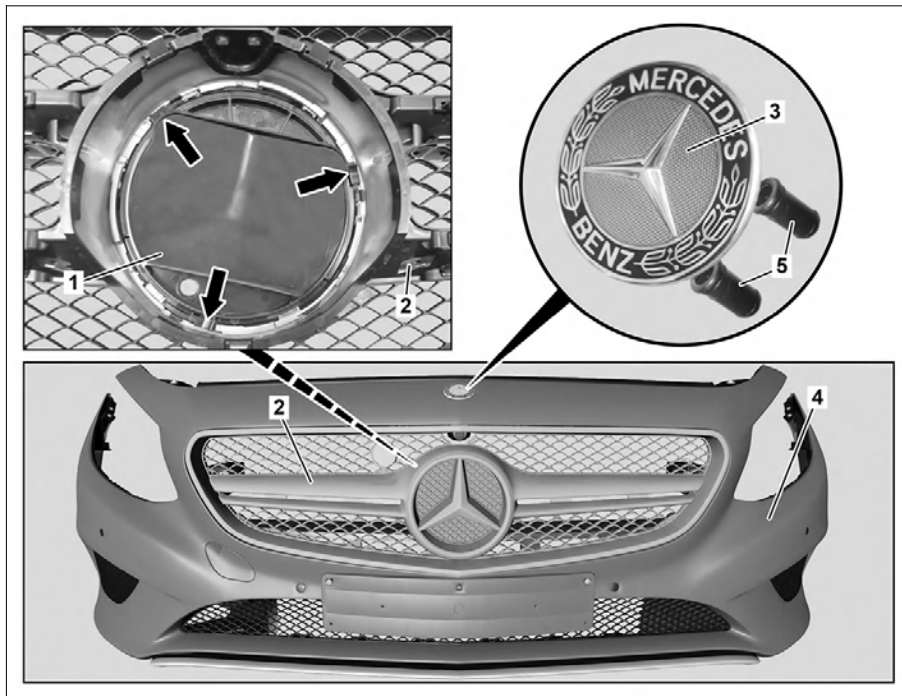

P88.40-3185-06



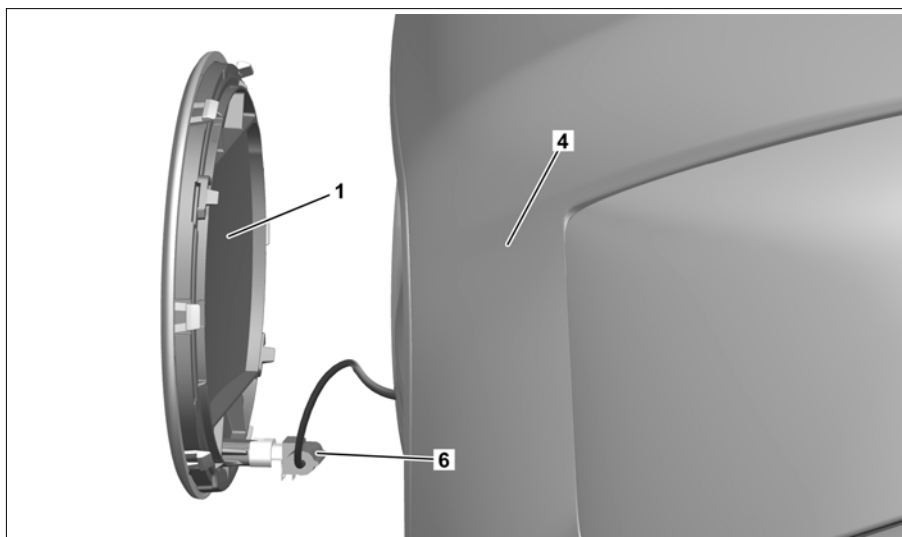

Shown on model 217 as of model year 2018 with code 233 (DISTRONIC PLUS)

- 1 Mercedes star
- 4 Front bumper
- 6 Electrical connector



P88.40-3410-05

☒ ☒	Remove/install		
1.1	Turn Mercedes star (1) by approx. 15° counterclockwise, remove from radiator grille (2) and disconnect electrical connector (6)	Model 217 as of model year 2018 with code 233 (DISTRONIC PLUS) When removing Mercedes star (1) in radiator grille (2).	
1.2	Turn Mercedes star (1) by approx. 15° counterclockwise and remove from radiator grille (2)	Model 217 as of model year 2018 except code 233 (DISTRONIC PLUS) Model 217 up to model year 2018 When removing Mercedes star (1) in radiator grille (2).	

2	Carefully remove Mercedes star (3) from front bumper (4)	<p>When removing Mercedes star (3) in front bumper (4).</p> <p> Removal: Carefully remove Mercedes star (3). Otherwise the paint will be damaged.</p> <p> Installation: Observe installation position of Mercedes star (3).</p> <p> Long wedge</p>	*115589035900
3	Remove grommets (5)	<p>When removing Mercedes star (3) in front bumper (4).</p> <p> Check grommet (5) for damage and replace if necessary.</p>	
4	Install in the reverse order		

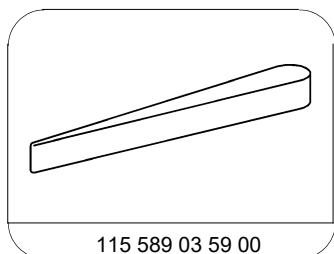

115 589 03 59 00

Long wedge