

ENGINES 112.945 in MODEL 463.209 /232 /233 /244 /245 /250
 ENGINES 112 in MODEL 129, 163, 170, 202, 203, 208, 209, 210, 220
 ENGINES 113.962 in MODELS 463.206 /240 /241 /247 /248 /249 /254
 ENGINES 113 in MODEL 129, 163, 202, 203, 208, 209, 210, 220
 ENGINES 113.982 in MODEL 463.243 /246
 ENGINES 113.989 in MODEL 171.473

Shown on engine 112

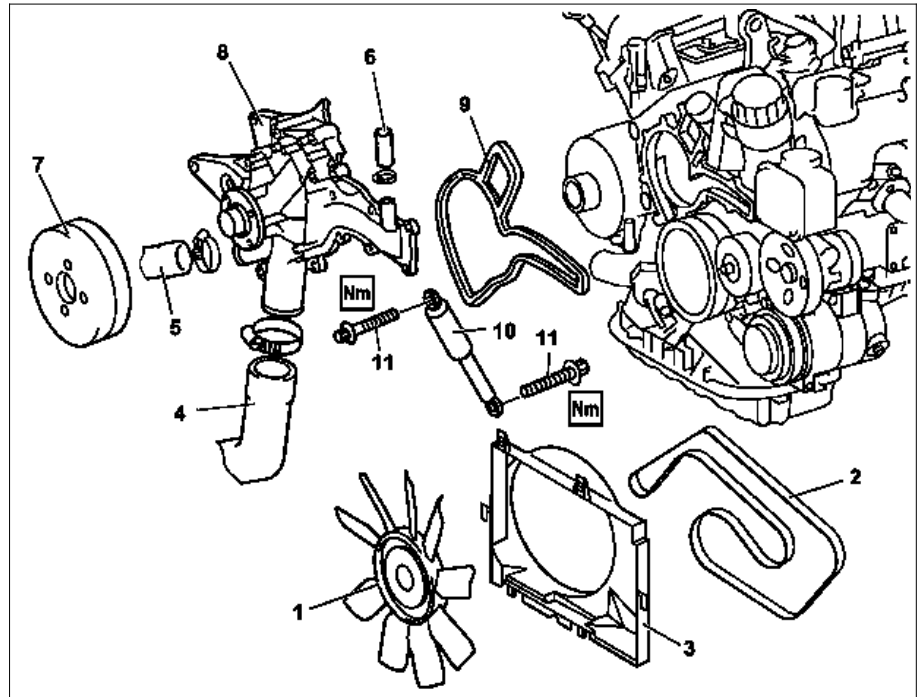

- 1 Viscous fan
- 2 Poly-V-belt
- 3 Fan shroud
- 4 Coolant hose
- 5 Coolant hose
- 6 Coolant hose to oil-water heat exchanger
- 7 Coolant pump belt pulley
- 8 Coolant pump
- 9 Coolant pump gasket
- 10 Shock absorber
- 11 Bolts













P20.10-0242-06

Modification notes

16.12.03	Value changed from 10 Nm to 9 Nm	Value in BA20.10-P-1002-01M modified on engine 112.910/911/912/913/914/915/916/917/920/921/922/923/940/941/942/943/944/945/946/947/949/953/954/955/960/961/970/972/973/975	*BA20.10-P-1002-01M
----------	----------------------------------	--	---------------------

	Remove/install		
⚠ Danger!	Risk of death caused by vehicle slipping or toppling off the lifting platform.	Align vehicle between columns of lifting platform and position four support plates at the lifting platform support points specified by vehicle manufacturer.	AS00.00-Z-0010-01A
1	Lift/jack up vehicle	Models 129, 170, 202, 208, 210, 220 Model 163 Model 171 Model 203, 209 Model 463	AR00.60-P-1000GH AR00.60-P-1000V AR00.60-P-1000P AR00.60-P-1000G
⚠ Danger!	Risk of injury caused by fingers being pinched or crushed when removing, installing or aligning hoods, doors, trunk lids, liftgates or sliding roof	Keep body parts and limbs well clear of moving parts.	AS00.00-Z-0011-01A
2	Open engine hood	Model 129 Model 163.154 /172 up to VIN A145272 Model 163.154 /172 up to VIN X708318 Model 163.154 /172 from VIN A145273 Model 163.154 /172 from VIN X708319 Model 163.157/ 174/ 175 Model 170 Model 171.4 Model 202 Model 203 Model 208 / 210 Model 209 Model 220 Model 463	AR88.40-P-1000GH AR88.40-P-1000GI AR88.40-P-1000G AR88.40-P-1000V AR88.40-P-1000E AR88.40-P-1000P AR88.40-P-1000F AR88.40-P-1000Q AR88.40-P-1000M AR88.40-P-1000GG
3.1	Unclip cover on front side of engine	 Only model 220.	

4.1	Remove engine cover or air filter	 All except models 170.466, 171.473, 203.065 /265, 203.076 /276, 209.376 /476 from 24.4.04.	
5.1	Partially remove air filter housing	Engine 112.960 in model 170.466 Engine 112.961 in model 203.065/ 265 Engine 113.987 in model 209.376 /476 as of 24.4.04 Engine 113.988 in model 203.076 /276 Engine 113.989 in model 171.473	AR09.10-P-1150SVK AR09.10-P-1150AC
6.1	Remove viscous fan (1)	All except models 163.174 /175, 170, 171.473, 203, 208.365 /465, 209, 220  Right-hand thread!	AR20.40-P-5660C
7.1	Remove fan shroud (3)	 On vehicles fitted with suction fan, separate the plug connection of the suction fan before removing the fan shroud (3). Model 171.473 with engine 113.989 Model 463 with engine 112.945, 113.962 /982 Model 220 with engine 112, 113	AR20.40-P-6800VT AR20.40-P-6800V AR20.40-P-6800AB
8.1	Remove electric fan	Model 163 with engines 113.965/ 981 Model 170 with engine 112.947 /960 Model 171.473 with engine 113.989 Model 203.076 /276 Model 203 with engines 112.912 /916 /946 /953 /961 Model 209 with engines 112.912 /955, 113.968 /987. Model 208.365 / 465	AR20.40-P-5000GH AR20.40-P-5000SV AR20.40-P-5000V AR20.40-P-5000AC AR20.40-P-5000PV
 Danger!	Risk of injury to skin and eyes caused by scalding from contact with hot coolant spray. Risk of poisoning caused by swallowing coolant.	Do not open cooling system unless coolant temperature is below 90°C. Open cap slowly and release the pressure. Do not pour coolant into beverage containers. Wear protective gloves, protective clothing and safety glasses.	AS20.00-Z-0001-01A
9	Drain coolant at radiator	 Model 163: For draining coolant, detach bottom coolant line at radiator or at coolant pump.  Installation: On model 163 replace radiator connection of hose clamps to coolant hose, otherwise this can cause a damage to the bolt/thread.  Hose clamp  Collect coolant  Disposal of coolants: observe legal regulations or local wastewater requirements! Refer to Environmental Protection Catalog issued by MBVD/PWU for locations in Germany. Model 129, 163, 202, 208, 210, 220 with engine 112 Model 220, 210, 208, 202, 163, 129 with engine 113 Model 463.206 /240 /241 /247 /248 /249 /254 with engine 113.962 Model 463.209 /232 /233 /244 /245 /250 with engine 112.945. Model 463.243 /246 with engine 113.982 Model 170.465 with engine 112.947 Model 170.466 with engine 112.960 Model 171.473 with engine 113.989 Model 203.061 /261 with engine 112.912 Model 203.064 /264 /764 with engine 112.946 Model 203.065 /265 with engine 112.961 Model 203.076 /276 with engine 113.988 Model 203.081 /281 with engine 112.916 Model 203.084 /284 with engine 112.953 Model 209.361 /461 with engine 112.912 Model 209.365 /465 with engine 112.955 Model 209.375 /475 with engine 113.968 Model 209.376 /476 with engine 113.987	*BA20.20-P-1004-01A AR20.00-P-1142HA AR20.00-P-1142SV AR20.00-P-1142PV
10	Remove poly-V belt (2)	 Lock tensioner pulley with drift or pin (diameter 5 mm).	

		<p>Model 463.209 /232 /233 /244 /245 /250 with engine 112.945. Model 463.206 /240 /241 /247 /248 /249 /254 with engine 113.962 Model 463.243 /246 with engine 113.982 Model 129, 163 with engine 112 Model 129, 202, 208.370 /470, 210 with engine 113 Model 163 with engine 113 except 113.965 /981 Model 202, 208, 210, 220 with engine 112 Model 220 with engine 113 except 220.074 /174 Model 163.174 with engine 113.981 Model 163.175 with engine 113.965 Model 208.374 /474 with engine 113 Model 220.074 / 174 Model 170.465 with engine 112.947 Model 170.466 with engine 112.960 Model 203.065 /265 with engine 112.961 Model 171.473 with engine 113.989 Model 203.061 /261 with engine 112.912 Model 203.064 /264 /764 with engine 112.946 Model 203.076 /276 with engine 113.988 Model 203.081 /281 with engine 112.916 Model 203.084 /284 with engine 112.953 Model 209.361 /461 with engine 112.912 Model 209.365 /465 with engine 112.955 Model 209.375 /475 with engine 113.968 Model 209.376 /476 with engine 113.987</p>	<p>AR13.22-P-1202B</p> <p>AR13.22-P-1202BA</p> <p>AR13.22-P-1202R AR13.22-P-1202SV AR13.22-P-1202SVK</p> <p>AR13.22-P-1202PV</p>
11.1	Remove shock absorber (10)	Model 210, 203, 209, 202, 170, 129 with manual transmission	
12	Remove poly-V-belt tensioning device	<p>Model 463.209 /232 /233 /244 /245 /250 with engine 112.945. Model 463.206 /240 /241 /247 /248 /249 /254 with engine 113.962 Model 463.243 /246 with engine 113.982 Model 129, 163 with engine 112 Model 129, 202, 208, 210 with engine 113 Model 163 with engine 113 except 113.965 /981 Model 163.174 with engine 113.981 Model 163.175 with engine 113.965 Model 170, 202, 203, 208, 209, 210, 220 with engine 112 Model 171.473 with engine 113.989 Model 203, 209, 220 with engine 113</p>	<p>AR13.25-P-3200B</p> <p>AR13.25-P-3200BA</p>
13	Disconnect coolant hose (4, 5)	i Check condition of coolant hoses and hose clamps, replace if necessary.	
14.1	Disconnect coolant hose (6) at oil-water heat exchanger	<p>i All except model 171.473.</p> <p>i Check condition of coolant hose and hose clamp; replace if necessary.</p>	
15.1	Remove bolts from oil lines on oil filter	<p>i Only model 171.473.</p> <p>Nm Bolt of oil line to oil filter housing</p>	*BA18.20-P-1003-01D
16.1	Remove bolts from oil lines brackets and lay oil lines with brackets to one side	<p>i Only model 171.473.</p> <p>Nm Bolt, oil line bracket</p>	*BA18.20-P-1004-01D
17.1	Remove bracket with switchover valve and pressure sensor and place to one side	i Only model 171.473.	
18	Take off belt pulley of coolant pump (7)	<p>i Engine 112: ↓ Nm Belt pulley on coolant pump</p> <p>i Engine 113, except 113.987 /988 /989 /991: ↓ Nm Belt pulley on coolant pump</p> <p>i Engines 113.987 /988 /989 /991: ↓ Nm Belt pulley on coolant pump</p> <p>i Engine 113.989: ↓ S Counterholder</p>	<p>*BA20.10-P-1002-01M</p> <p>*BA20.10-P-1002-01C</p> <p>*BA20.10-P-1002-01L</p> <p>*113589004000</p>
19	Remove coolant pump (8)	<p>i Installation: Replace gasket of coolant pump (9).</p> <p>i Engine 112: ↓ Nm Self-tapping screw for coolant pump to timing case</p>	*BA20.10-P-1001-01M

		<i>i</i> Engine 113 except 113.987 /988 /989 /991: ↓ <i>Nm</i> Self-tapping screw for coolant pump to timing case <i>i</i> Engines 113.987 /988 /989 /991: ↓ <i>Nm</i> Bolt, coolant pump to timing case <i>i</i> Engine 112, 113: ↓ <i>Nm</i> Alternator screw <i>S</i> External torx set	*BA20.10-P-1001-01C *BA20.10-P-1001-01L *BA15.40-P-1003-01A *001589760900
20	Install in the reverse order		
21	Inspecting cooling system for leaks	<i>i</i> All except models 170, 171.473, 203, 209, 220.074 /174 Model 170, 171.473, 203, 209 Model 220.074 / 174	AR20.00-P-1010HA AR20.00-P-1010P AR20.00-P-1010RVK

Nm Alternator

Number	Designation	Engine 112.91/92/94/953/954/955/96/97 except 112.976, engine 113.94/96/98	Engine 113.991 in model 215, 220
BA15.40-P-1003-01A	Alternator bolt	Nm 42	-

Nm Oil filter

Number	Designation	Engine 113.989
BA18.20-P-1003-01D	Bolt, oil line to oil filter housing	Nm 9
BA18.20-P-1004-01D	Bolt for oil line bracket	Nm -

Nm Coolant pump, coolant thermostat

Number	Designation	Engine 112.910/911/912 /913/914/915/916/917/920/921/922/923/940/941/942/943/944/945/946/947/949/953/954/955/960/961/970/972/973/975
BA20.10-P-1001-01M	Self-tapping bolt, connecting coolant pump to timing case	Thread not pre-tapped M6 Nm 14
		Thread not pre-tapped M8 Nm 35
		Thread pre-tapped M6 Nm 10

		Thread pre-tapped	M8	Nm	25
BA20.10-P-1002-01M	Belt pulley on coolant pump			Nm	9

Nm Coolant pump, coolant thermostat

Number	Designation				Engine 113.940/941/ 942/943/944/ 945/946/948/ 960/961/962/ 963/965/966/ 967/968/969/ 980/981/982/ 984/986/992 993/995
BA20.10-P-1001-01C	Self-tapping bolt, connecting coolant pump to timing case	Thread not pre-tapped	M6	Nm	14
		Thread not pre-tapped	M8	Nm	35
		Thread pre-tapped	M6	Nm	10
		Thread pre-tapped	M8	Nm	25
BA20.10-P-1002-01C	Belt pulley on coolant pump			Nm	10

Nm Coolant pump, coolant thermostat

Number	Designation			Engine 113.987/988/ 990/991	Engine 113.989
BA20.10-P-1001-01L	Bolt, coolant pump to timing case	M6	Nm	14	14
		M8	Nm	20	20
BA20.10-P-1002-01L	Belt pulley on coolant pump			Nm	9

Nm Radiator, coolant hoses

Number	Designation		Engine 112.942/ 970, 113.942/ 965/981
BA20.20-P-1004-01A	Hose clamp	Nm	3

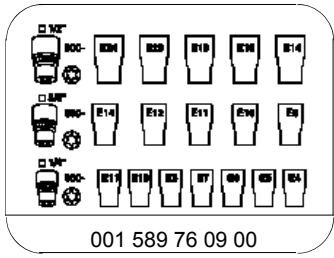

External Torx set

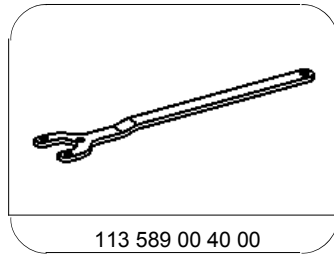

Counterholder