

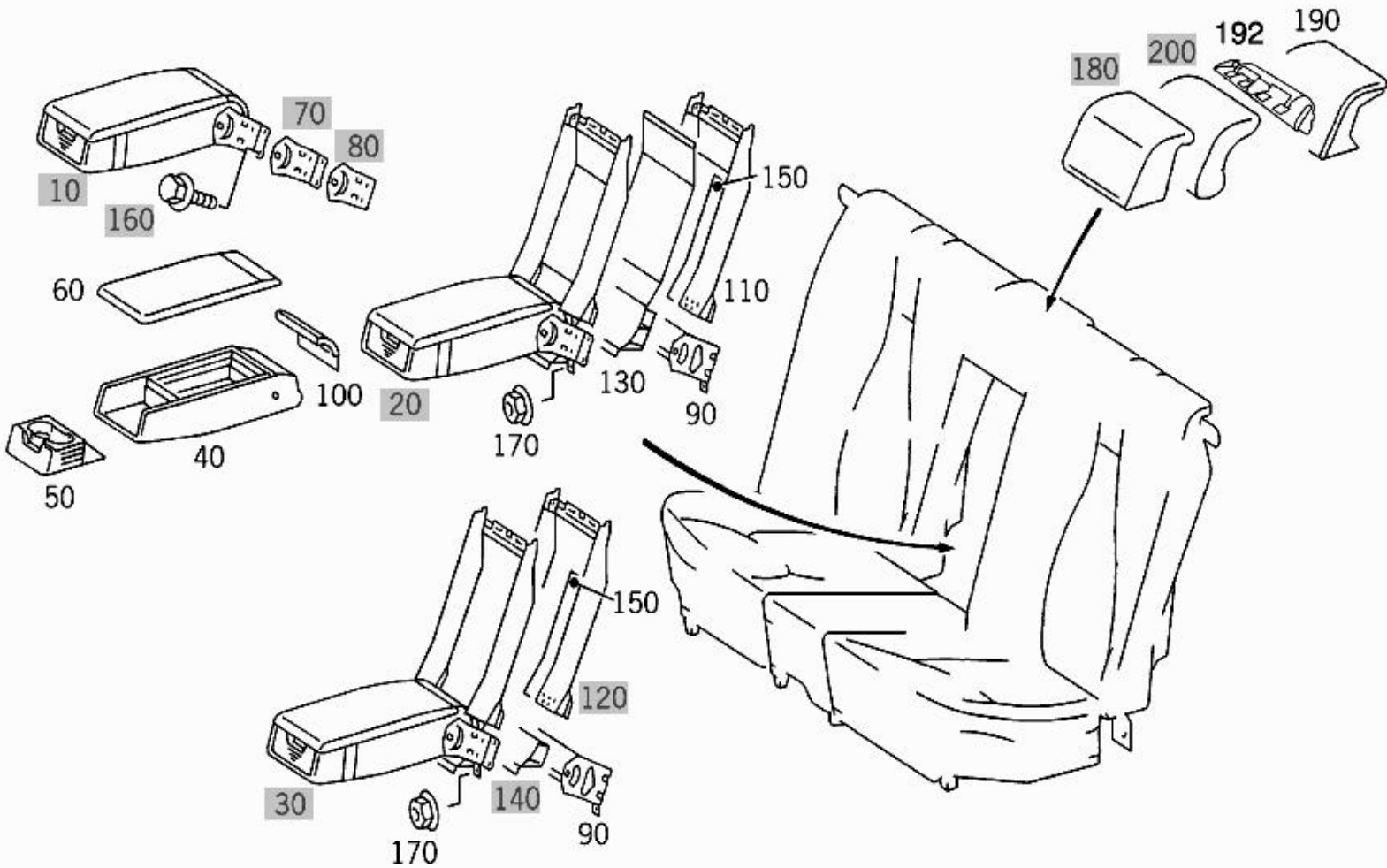





# - Picture -

<b>Mode</b>	MD mode	<b>Mod. des. overview</b>	S-SEDAN LONG WHEELBASE
<b>FIN/MD</b>	WDB 2201761A327121	<b>Catalog</b>	66T
<b>VIN</b>	WDBNG76J23A327121	<b>Major assembly:</b>	
<b>Sales designation</b>	S 600	<b>Major assembly MD</b>	
<b>Assortment class</b>	Car	<b>Group</b>	92 - REAR SEAT BENCH
<b>Market</b>	North America	<b>Subgroup</b>	075 - FOLDING ARMREST,SEAT ADAPTER
<b>Picture number</b>	B92075000001.030919		



## - Parts list -

<b>Mode</b>	MD mode	<b>Mod. des. overview</b>	S-SEDAN LONG WHEELBASE
<b>FIN/MD</b>	WDB 2201761A327121	<b>Catalog</b>	66T
<b>VIN</b>	WDBNG76J23A327121	<b>Major assembly:</b>	
<b>Sales designation</b>	S 600	<b>Major assembly MD</b>	
<b>Assortment class</b>	Car	<b>Group</b>	92 - REAR SEAT BENCH
<b>Market</b>	North America	<b>Subgroup</b>	075 - FOLDING ARMREST,SEAT ADAPTER

Item no.	Part number	Designation/description	Quantity	Version
40	A 220 970 12 30 9C05	. <b>FOLDING ARMREST</b> LEATHER Code: 223+540A/224+540A/223+840...  [922] Color footnote	001	
40	A 220 970 12 30 9C05	. <b>FOLDING ARMREST</b> LEATHER Code: 223+540A/224+540A/223+840...  [906] Color footnote	001	
50	A 220 970 00 14 8G88	. <b>BRACKET</b> Code: 223+731/224+731  [924] Color footnote	001	
60	A 220 970 10 29 9C05	. <b>COVER</b> EXCLUSIV/CONDOR/EXCLUSIV AMG/LEATHER NAPPA LEATHER/DESIGNO COUTURE Code: 223+540A/224+540A/223+840...  [002, 906] Color footnote	001	
90	A 220 973 02 20	. <b>BEARING</b> Code: 223/224	001	
100	A 220 973 00 89 9B51	. <b>COVER</b> Code: 223/224  [926] Color footnote	001	
110	A 220 970 02 43	. <b>FRAME</b> Code: 223/224	001	
130	A 220 923 00 22 9B51	. <b>COVER</b> Code: 223/224  [926] Color footnote	001	
150	A 220 973 01 89	. <b>COVER</b> LEFT Code: 223/224	001	
150	A 220 973 02 89	. <b>COVER</b> RIGHT Code: 223/224	001	
170	N 000000 003175	<b>NUT</b> ARMREST TO REAR PANEL M8 Code: 223/224	002	
190	A 220 920 22 16	<b>REST</b> SEAT ADAPTER Code: 223/224	001	
192	A 220 923 00 38	<b>STIFFENING</b> BACKREST Code: 223/224	001	