

<b>AR72.10-P-1710SX</b>	<b>Remove/install trim strip on front door window frame</b>	<b>20.9.06</b>
-------------------------	---	----------------

**MODEL 221.0**

**MODEL 221.1 except CODE (Z07) Top protection**

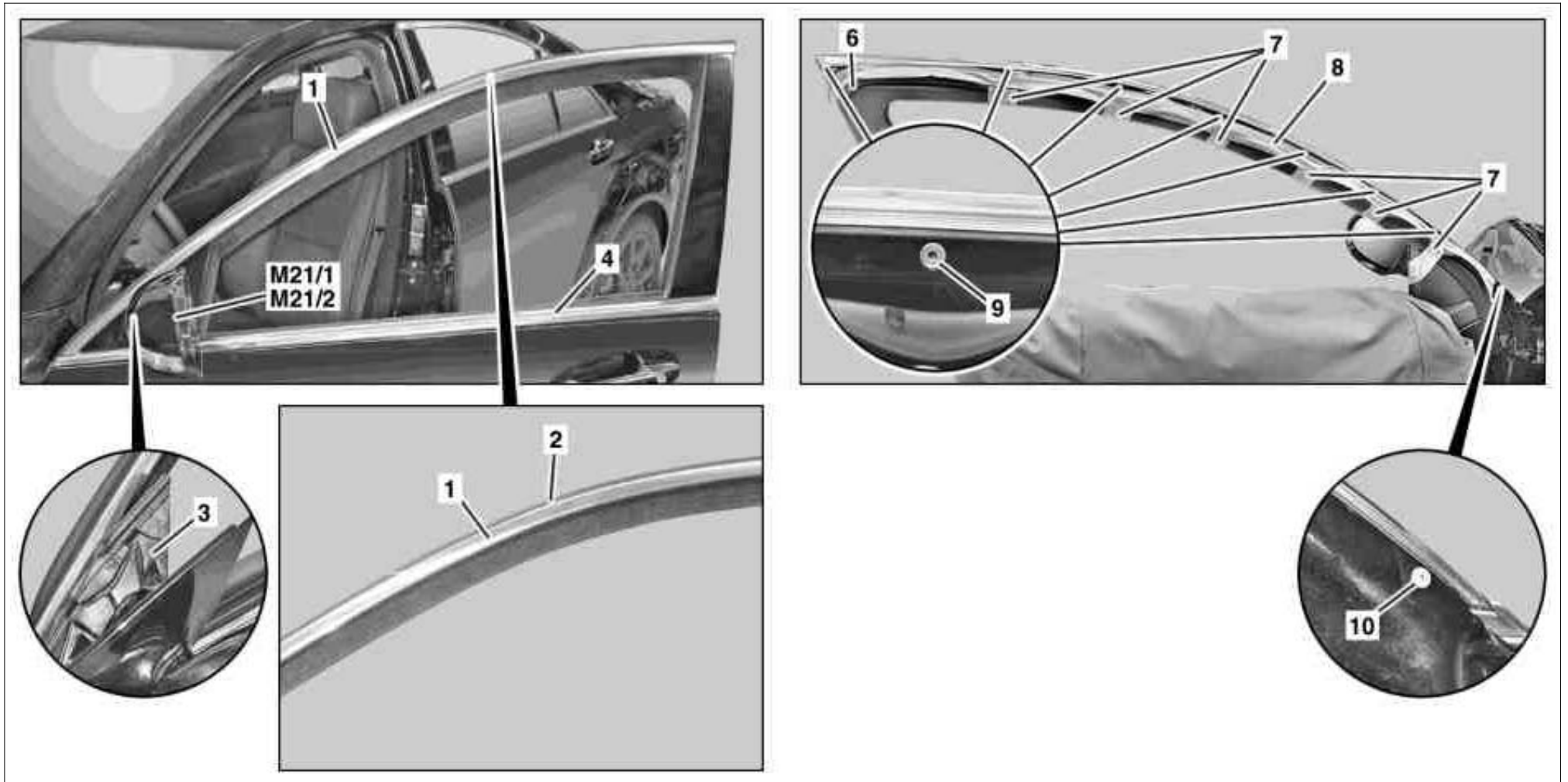







P72.10-3368-09







**Shown on left front door**

- |   |                      |    |                      |        |   |
|---|----------------------|----|----------------------|--------|---|
| 1 | Trim strip           | 7  | Adhesive tape strips | M2 1/1 | Left electrically adjustable and heated outside mirror  |
| 2 | Sealing              | 8  | Adhesive tape strips | M2 1/2 | Right electrically adjustable and heated outside mirror |
| 3 | Mirror triangle seal | 9  | Rivet                |        |   |
| 4 | Outer sealing rail   | 10 | Rivet                |        |   |
| 6 | Door sealing frame   |    |                      |        |   |

## Modification notes

23.9.05	Riveter changed	Step 11	
---------	-----------------	---------	--

	Remove/install		
1	Remove sealing (2) from trim strip (1).		AR72.10-P-1550SX
2	Completely lower crank window		
3	Remove left electrically adjustable and heated outside mirror (M21/1) or right electrically adjustable and heated outside mirror (M21/2), lay down inside with electrical line connected and mirror triangle seal (3) detached.	  	*110589035900  *BA88.70-P-1001-01C
4	Cover door lining and left electrically adjustable and heated outside mirror (M21/1) or right electrically adjustable and heated outside mirror (M21/2) to protect against drilling chips falling down.		
5	Remove outer sealing rail (4)		*110589035900
6	Pull door frame seal (6) downward in areas of rivets (9) and fasten with strips of adhesive tape (7).	 Do not pull door frame seal (6) downward too forcefully, otherwise the glued door frame seal (6) can detach from the window frame.  This prevents damaging the door frame seal (6) when drilling out the rivets (9) later.	
7	Mask gap between door frame seal (6) and window frame over entire length with strips of adhesive tape (8).	 This ensures that no chips or drilling residues fall into the gap.	

8	Mask end of rivet (10) from inside with strips of adhesive tape	 This ensures that the end of the rivet does not fall into the front door when drilling out.	
9	Mask A-pillar opposite rivet (10) with strips of adhesive tape.	 Otherwise the paint on the A-pillar can be damaged when drilling out the rivet (10).	
10	Drill out rivet heads on rivets (9, 10) with dia. 3.5 mm bit.	 Do not drill through rivets (9, 10) to prevent damaging the window frame. Manual pliers, see GOTIS <a href="http://gotis.aftersales.mercedes-benz.com">http://gotis.aftersales.mercedes-benz.com</a>	
11	Completely remove rivet residues.	 Remaining rivet residues cause corrosion damage.	
12	Loosen trim strip (1) and remove from window frame.	 <b>Installation:</b> Repair paint damage on window frame before assembly. 	*110589035900
13	Install in the reverse order		

## Outside mirrors

Number	Designation		Model 221
BA88.70-P-1001-01C	Screw for outside rearview mirror on front door	Nm	2

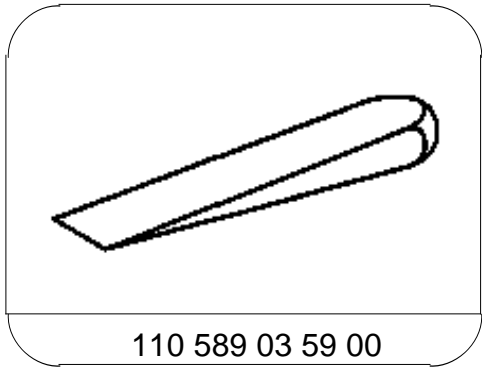

110 589 03 59 00

Wedge tool