

- Parts list -

Mode	BM mode	Market	
VIN/mod. des.	WDD2210941A440128	BM overview	S500 CGI 4MATIC
VIN	WDDNF9EB0CA440128	Catalog	D64
Assortment class	PC	Group	88 ATTACHMENT PARTS
		Sub-group	075 REAR BUMPER

Copyright 2019-03-31 Daimler AG

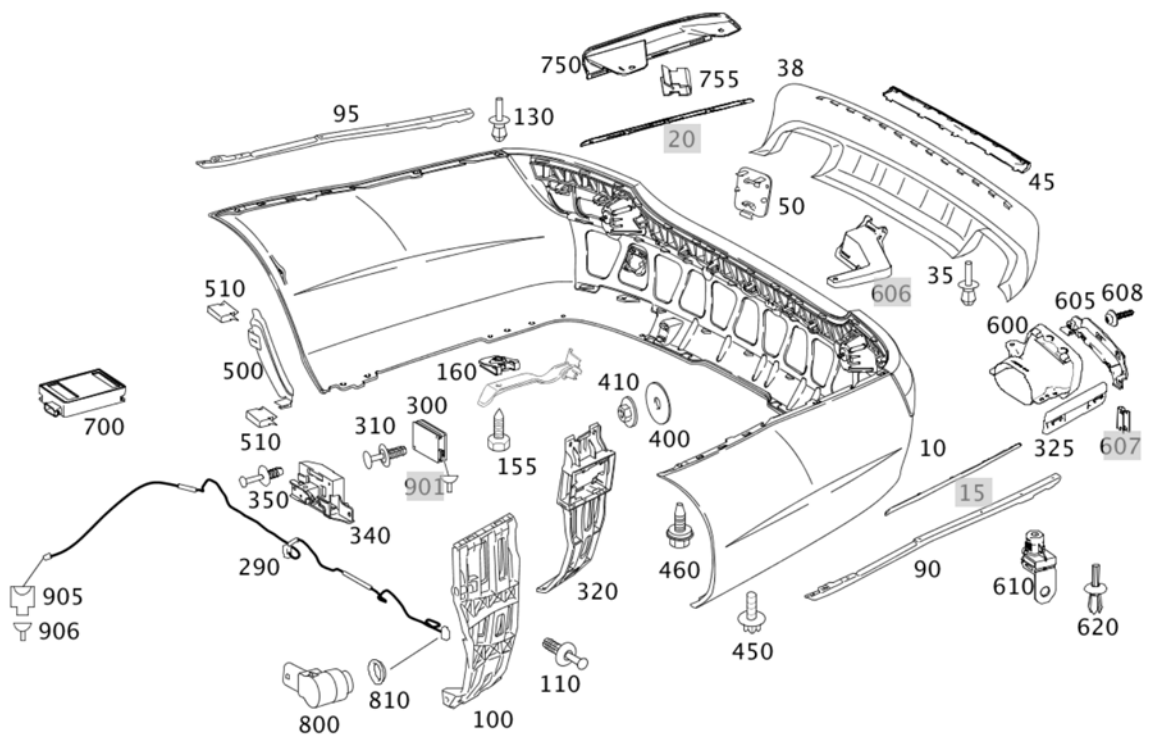



































Image ID: drawing_B88075000202

Item	Part number	Designation/additional information	Qty
10	A 221 880 47 40 9999	TRIM, BUMPER REAR BUMPER Code: (772+(220/230/234))+-(M156/M275+M60/M157);	1
35	A 000 990 34 92	EXPANSION RIVET EXHAUST SCREEN; 5 MM	4
38	A 221 885 20 25	TRIM, BUMPER BLACK Code: 772+-(M60/M63/M157);	1
45	A 221 885 21 25 9999	TRIM, BUMPER BUMPER, BOTTOM SECTION Code: 772+-(M156+M63/M157+M55/M275+M60);	1

Item	Part number	Designation/additional information	Qty
50	A 221 885 29 22 9999	COVER, TOWING EYE TOWING EYE  Code: 772/772+(264/460+264/835);	1
90	A 221 885 01 16	REINFORCEMENT LEFT TOP	1
95	A 221 885 02 16	REINFORCEMENT RIGHT TOP	1
100	A 221 885 03 63	BUMPER LATERAL SUPPORT LEFT REAR	1
100	A 221 885 04 63	BUMPER LATERAL SUPPORT RIGHT REAR	1
110	A 000 990 54 92 9051	RIVET SUPPORT; 6 MM  Code: 772;	4
110	A 000 990 54 92 9051	RIVET GUIDE TO PANELLING; 6 MM	6
130	A 001 990 24 92	EXPANSION RIVET REINFORCEMENT TO BUMPER COVERING; 4 MM	6
155	N 000000 000927	TAPPING SCREW BRACKET MOUNTING; ST4.8X25-R-B	2
160	A 003 994 85 45	SPRING NUT BRACKET MOUNTING; 4.8/0.5-2.5 MM	2
290	A 221 440 20 08	ELECTRICAL WIRING HARNESS IN REAR BUMPER  Code: (234/237)+(220/230);	1
300	A 000 906 20 00	RADAR SENSOR BLIND SPOT ASSISTANT  Code: (234/237)+(802/803/804);  [672] PART MUST BE CHECKED FOR CURRENT FLASHWAR...	2
300	A 000 905 01 10	RADAR SENSOR BLIND SPOT ASSISTANT  Code: (234/237)+(802/803/804);  [672] PART MUST BE CHECKED FOR CURRENT FLASHWAR...	2
310	A 000 990 54 92 9051	RIVET SENSOR TO BRACKET; 6 MM  Code: (230/234/237)+-M019;	8
320	A 221 885 13 14	BRACKET SENSOR LEFT  Code: (220/230)+(234/237);	1
320	A 221 885 14 14	BRACKET SENSOR RIGHT  Code: (220/230)+(234/237);	1
325	A 221 885 27 14	BRACKET TO BUMPER LEFT  Code: 772+(220/230)+(234/237);	1
325	A 221 885 28 14	BRACKET TO BUMPER RIGHT  Code: 772+(220/230)+(234/237);	1
340	A 221 885 11 67	HOUSING INSIDE LEFT  Code: 229/230/234/237;	1

Item	Part number	Designation/additional information	Qty
340	A 221 885 10 67	HOUSING INSIDE RIGHT  Code: 229/230/234/237;	1
350	A 000 990 54 92 9051	RIVET HOUSING FASTENING; 6 MM  Code: 230/234/237;	6
400	A 201 990 02 40	SEALING WASHER MOUNTING BUMPER	2
410	A 414 990 00 51	NUT MOUNTING BUMPER; M6	2
450	N 910143 006001	HEXALOBULAR BOLT BUMPER ATTACHMENT,LATERAL; M6X16	2
460	A 001 990 46 36	SCREW BUMPER ATTACHMENT,LATERAL; 6X18	4
500	A 221 885 21 23	COVER, BUMPER AREA LEFT REAR BUMPER  Code: 772;	1
500	A 221 885 20 23	COVER, BUMPER AREA RIGHT REAR BUMPER  Code: 772;	1
510	A 001 988 76 78	CLAMP MOUNTING, COVER  Code: 772;	6
600	A 221 490 29 27	TAIL PIPE TRIM LEFT  Code: 772+-(M275/M157);	1
600	A 221 490 30 27	TAIL PIPE TRIM RIGHT  Code: 772+-(M275/M157);	1
605	A 221 885 29 14	ANGLE BRACKET LEFT	1
605	A 221 885 30 14	ANGLE BRACKET RIGHT	1
608	A 001 984 17 29	SCREW TAIL PIPE	4
608	A 001 984 17 29	SCREW PANEL  Code: 772;	4
610	A 001 990 11 56	CLIP NUT EXHAUST SCREEN  Code: 772;	4
620	A 000 990 34 92	EXPANSION RIVET AT ANGLE; 5 MM	4
700	A 000 906 20 00	RADAR SENSOR IN REAR BUMPER  Code: 234/237;  [672] PART MUST BE CHECKED FOR CURRENT FLASHWAR...	2
750	A 221 885 16 14	BRACKET LEFT AND RIGHT  Code: 772/772+(264/460+264/835);	2
750	A 221 885 25 14	BRACKET SHIELD LEFT  Code: 772;	1

Item	Part number	Designation/additional information	Qty
750	A 221 885 26 14	BRACKET SHIELDING RIGHT  Code: 772;	1
755	A 001 988 76 78	CLAMP ATTACHMENT SHIELD  Code: 772;	6
800	A 212 542 00 18 9197	DISTANCE SENSOR IN REAR BUMPER  Code: 220/230;  [420] TO BE PAINTED PRIOR TO INSTALLATION	4
810	A 221 542 00 51	* SPACER RING SENSOR  Code: 772+(220/230);	4
905	A 038 545 12 28	CLUTCH REAR BUMPER CONNECTOR X172/2; 4-PIN MQS  Code: 229/230/234;	1
906	A 016 545 41 26	CONTACT SOCKET REAR BUMPER CONNECTOR X172/2; 0.25-0.5 MM2 MQS  Code: 229/230/234;	NB