

- Parts list -

Mode	BM mode	Catalog	65V
VIN/mod. des.	WDD2163732A029556	Major assembly	Chassis
VIN		Major assy. mod. des.	C216373
Assortment class	PC	Group	13 POWER STEERING PUMP, AC COMPRESSOR AND
Market		Sub-group	025 HYDRAULIC PUMP
BM overview	CL 500 BlueEFFICIENCY		

Copyright 2020-03-03 Daimler AG

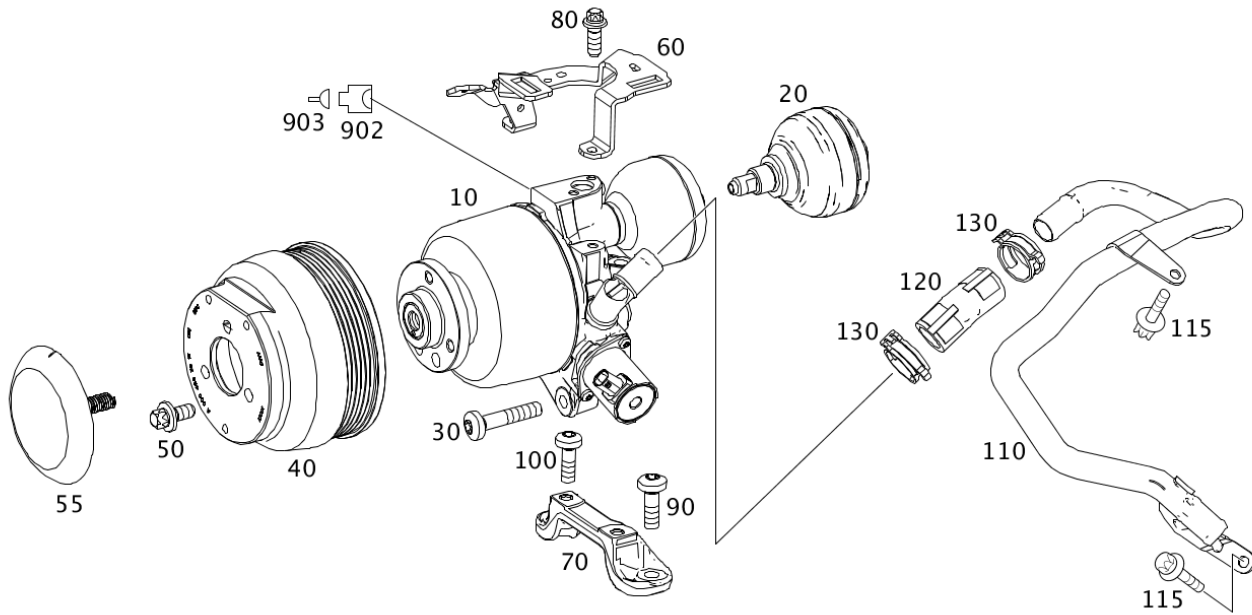

























Image ID: drawing_PV000.001.692.132_version_001

Item	Part number	Designation/additional information	Qty
10	A 000 329 15 03	HYDRAULIC PUMP Replaced by: A 000 329 01 00 Code: F216/(F217/F221/F222/F231)+487+-M005; [697] PART IS ONLY OR ALSO SUPPLIED AS RECONDITIONED PART Plant information Fault location 32501 Alternative parts are available	1

Item	Part number	Designation/additional information	Qty
10	A 000 329 01 00 	HYDRAULIC PUMP Replaces: A0003291503  Code: F216/(F217/F221/F222/F231)+487+M005;  [697] PART IS ONLY OR ALSO SUPPLIED AS RECONDITIONED PART  Fault location 32501  Alternative parts are available	1
20	A 000 466 03 10 	* PULSATION DAMPER  Code: F216/(F217/F221/F222/F231)+487;  [697] PART IS ONLY OR ALSO SUPPLIED AS RECONDITIONED PART  Alternative parts are available	1
30	N 000000 001153	HEXALOBULAR BOLT POWER STEERING PUMP TO WATER PUMP; M8X40  Code: F216/(F217/F221/F222/F231)+487;	4
40	A 000 466 26 15	BELT PULLEY  Code: F216/(F217/F221/F222/F231)+487;	1
50	N 910105 008008	HEXAGON HEAD BOLT PULLEY TO PUMP; M8X16  Code: F216/(F217/F221/F222/F231)+487;	3
55	A 278 031 01 33	PROTECTIVE RING Replaced by: A 278 031 02 33  Code: (F216/F217)/(F221/F222/F231)+487;  Plant information	1
55	A 278 031 02 33	PROTECTIVE RING Replaces: A2780310133  Code: F216/(F217/F221/F222/F231)+487;  Plant information	1
60	A 278 236 15 40	BRACKET  Code: F216/(F217/F221/F222/F231)+487;	1
70	A 278 236 13 40	BRACKET TO HYDRAULIC PUMP AT REAR Replaced by: A 278 236 27 40 +2 N000000002138 HEXALOBULAR BOLT  Code: F216/(F221/F222/F231)+487;	1
70	A 278 236 27 40	BRACKET TO HYDRAULIC PUMP AT REAR Replaces: A2782361340 +2 N000000002138  Code: F216/(F217/F221/F222/F231)+487;	1
70	A 278 236 27 40	BRACKET TO REAR PUMP  Code: F216/(F217/F221/F222/F231)+487;	1
80	N 910142 006001	HEXALOBULAR BOLT BRACKET TO PUMP; M6X16  Code: F216/(F217/F221/F222/F231)+487;	2
80	N 000000 001428	HEXALOBULAR BOLT PUMP TO BRACKET; M8X25  Code: F216/(F217/F221/F222/F231)+487;	2
90	N 000000 001428	HEXALOBULAR BOLT PUMP TO CYLINDER HEAD; M8X25  Code: F216/(F217/F221/F222/F231)+487;	2
100	N 000000 001428	HEXALOBULAR BOLT PUMP TO BRACKET; M8X25  Code: F216/(F217/F221/F222/F231)+487;	2

Item	Part number	Designation/additional information	Qty
110	A 222 327 00 44	INTAKE MANIFOLD  Code: F216/(F217/F221/F222/F231)+487;	1
115	N 910143 006000	HEXALOBULAR BOLT LOW-PRESSURE LINE TO CYLINDER HEAD COVER; M6X12  Code: F216/(F217/F221/F222/F231)+487;  Plant information	2
115	N 000000 006341	HEXALOBULAR BOLT LOW-PRESSURE LINE TO CYLINDER HEAD COVER  Code: F216/(F217/F221/F222/F231)+487;	2
120	A 221 320 04 55	INTAKE HOSE Replaced by: A 221 320 05 55  Code: F216/F217/(F221/F222/F231)+487;  Plant information	1
120	A 221 320 05 55	INTAKE HOSE  Code: F216/(F217/F221/F222/F231)+487;	2
130	A 000 995 30 05	SPRING BRACKET CLAMP SUCTION HOSE FASTENING; 26 MM  Code: F216/(F217/F221/F222/F231)+487;	2
902	A 022 545 19 26	CLUTCH HOUSING OIL PUMP Y130; 2-PIN MLK1.2 Replaced by: A 029 545 10 26	1
902	A 029 545 10 26	COUPLING HOUSING OIL PUMP Y130; 2-PIN MLK1.2 Replaces: A0225451926	1
903	A 000 982 30 26	CRIMP CONNECTOR CONTACT 0.75-1.0 MM2 MLK1.2S	NB
903	A 003 982 73 26	CONTACT SOCKET 0.75-1.0 MM2 MLK1.2SM	NB
903	A 001 545 50 80	SINGLE-WIRE SEAL YELLOW; 0.22-1.0 MM2 MLK1.2	NB