

- Parts list -

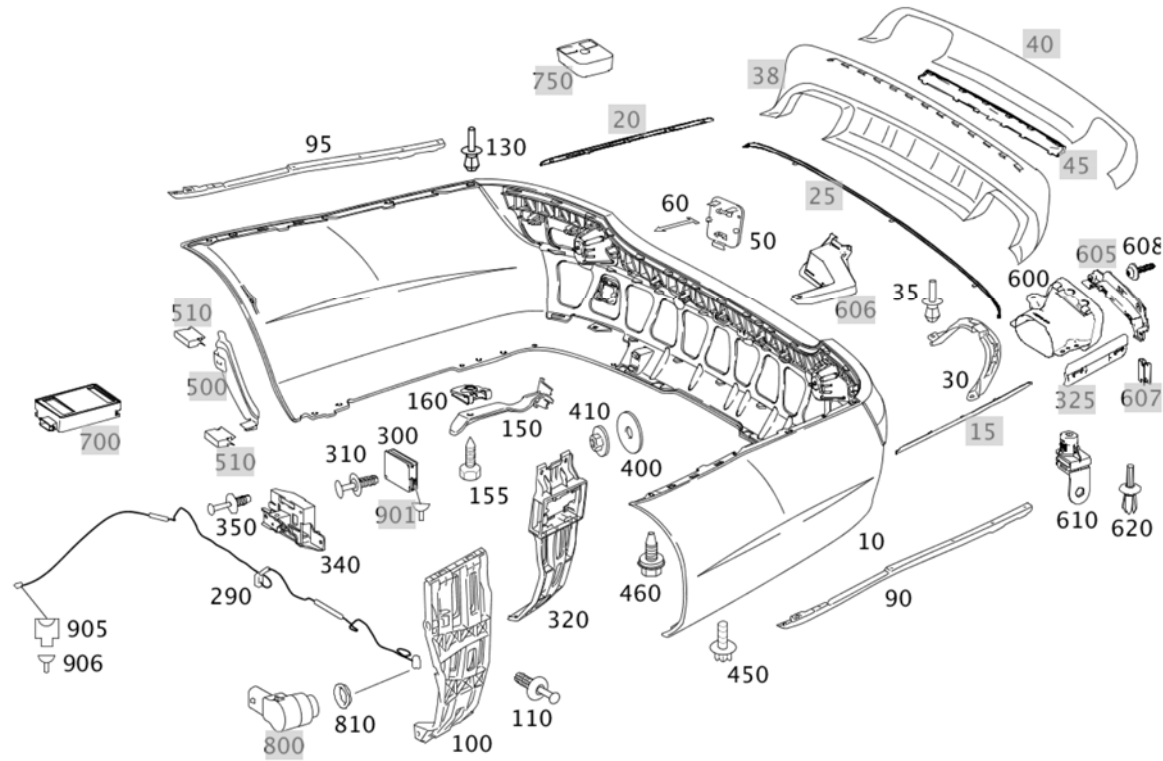



Mode	BM mode	Market	
VIN/mod. des.	WDD2211761A229467	BM overview	S 600
VIN	WDDNG76X48A229467	Catalog	63V
Assortment class	PC	Group	88 ATTACHMENT PARTS
		Sub-group	075 REAR BUMPER





























Copyright 2020-07-04 Daimler AG



Image ID: drawing_B88075000153

Item	Part number	Designation/additional information	Qty
------	-------------	------------------------------------	-----

Item	Part number	Designation/additional information	Qty
10	A 221 880 06 40	TRIM REAR BUMPER  Code: (264/460+264/835)+(M275+M55)+-220;  [420, 001637, 409] TO BE PAINTED PRIOR TO INSTALLATION  Plant information	1
30	A 221 885 09 22	COVER BUMPER BOTTOM LEFT  Code: (M275+M55)+(264/460+264/835)+-(772/800);  Plant information	1
30	A 221 885 10 22	COVER BUMPER BOTTOM RIGHT  Code: (264/460+264/835)+(M275+M55)+-772;  Plant information	1
35	A 000 990 25 92 9051	EXPANSION RIVET ORNAMENTAL COVER TO BUMPER  Code: (M275+M55)+-772;	6
50	A 221 885 11 23	COVER TOWING EYE  Code: (264/460+264/385)+-772;  Plant information	1
60	A 220 885 00 59	BAND COVER  Plant information	1
90	A 221 885 01 16	REINFORCEMENT LEFT TOP	1
95	A 221 885 02 16	REINFORCEMENT RIGHT TOP	1
100	A 221 885 01 63	GUIDE LEFT REAR  Plant information	1
100	A 221 885 02 63	GUIDE RIGHT REAR  Plant information	1
110	A 000 990 54 92 9051	RIVET GUIDE TO PANELLING; 6 MM  Plant information	6
130	A 001 990 24 92	EXPANSION RIVET REINFORCEMENT TO BUMPER COVERING; 4 MM	6

Item	Part number	Designation/additional information	Qty
150	A 221 885 03 14	BRACKET BUMPER MOUNTING,BELOW  Code: -(M60/M63/772);  Plant information	2
155	N 000000 001452	TAPPING SCREW BRACKET MOUNTING; 4.8X13  Plant information	2
160	A 003 994 85 45	SPRING NUT BRACKET MOUNTING; 4.8/0.5-2.5 MM	2
290	A 221 540 60 07	WIRING HARNESS IN REAR BUMPER  Code: 230/234;  Plant information	1
300	A 002 540 91 17	DISTANCE RADAR CITY ASSIST SYSTEM (CAS)  Code: 230/234;  Plant information	2
300	A 002 540 91 17	DISTANCE RADAR CITY ASSIST SYSTEM (CAS)  Code: 229/230/234;  Plant information	2
310	A 000 990 54 92 9051	RIVET SENSOR TO BRACKET; 6 MM  Code: (230/234/237)+-M019;	8
320	A 221 885 05 14	BRACKET SENSOR LEFT  Code: (230/234);  Plant information	1
320	A 221 885 06 14	BRACKET SENSOR RIGHT  Code: (230/234);  Plant information	1
340	A 221 885 11 67	HOUSING INSIDE LEFT  Code: 229/230/234/237;	1
340	A 221 885 10 67	HOUSING INSIDE RIGHT  Code: 229/230/234/237;	1

Item	Part number	Designation/additional information	Qty
350	A 000 990 54 92 9051	RIVET HOUSING FASTENING; 6 MM  Code: 230/234/237;	6
400	A 201 990 02 40	SEALING WASHER MOUNTING BUMPER	2
410	A 414 990 00 51	NUT MOUNTING BUMPER; M6	2
450	N 910143 006001	HEXALOBULAR BOLT BUMPER ATTACHMENT,LATERAL; M6X16	2
460	A 001 990 46 36	SCREW BUMPER ATTACHMENT,LATERAL; 6X18	4
600	A 221 490 15 27	TAIL PIPE TRIM LEFT Replaced by: A 221 490 39 27  Code: M275+-772;  Plant information	1
600	A 221 490 39 27	TAIL PIPE TRIM LEFT Replaces: A2214901527  Code: M275+-772;	1
600	A 221 490 16 27	TAIL PIPE TRIM RIGHT Replaced by: A 221 490 40 27  Code: M275+-772;  Plant information	1
600	A 221 490 40 27	TAIL PIPE TRIM RIGHT Replaces: A2214901627  Code: M275+-772;	1
608	A 001 984 17 29	SCREW TAIL PIPE	4
610	A 001 990 11 56	CLIP NUT EXHAUST SCREEN  Code: -772;	4
620	A 000 990 34 92 	EXPANSION RIVET AT ANGLE; 5 MM	4
810	A 204 542 00 51 	* DECOUPLING RING SENSOR  Code: 220/230;	4

Item	Part number	Designation/additional information	Qty
905	A 038 545 12 28	CLUTCH, MECHANICAL REAR BUMPER CONNECTOR X172/2; 4-PIN MQS  Code: 229/230/234;	1
906	A 016 545 41 26	CONTACT SOCKET REAR BUMPER CONNECTOR X172/2; 0.25-0.5 MM2 MQS  Code: 229/230/234;	NB