

- Parts list -

<b>Vehicle</b>	WDD2210221A283482 (63W)	320/350	
<b>Color</b>	197 - OBSIDIANSCHWARZ - METALLICLACK	<b>Equipment</b>	204 - LEDER - BRAUN
<b>Assortment class</b>	PC	<b>Group</b>	82 ELECTRICAL SYSTEM
<b>Sub-group</b>	325 CONTROL DISPLAY SYSTEM "COMAND"		

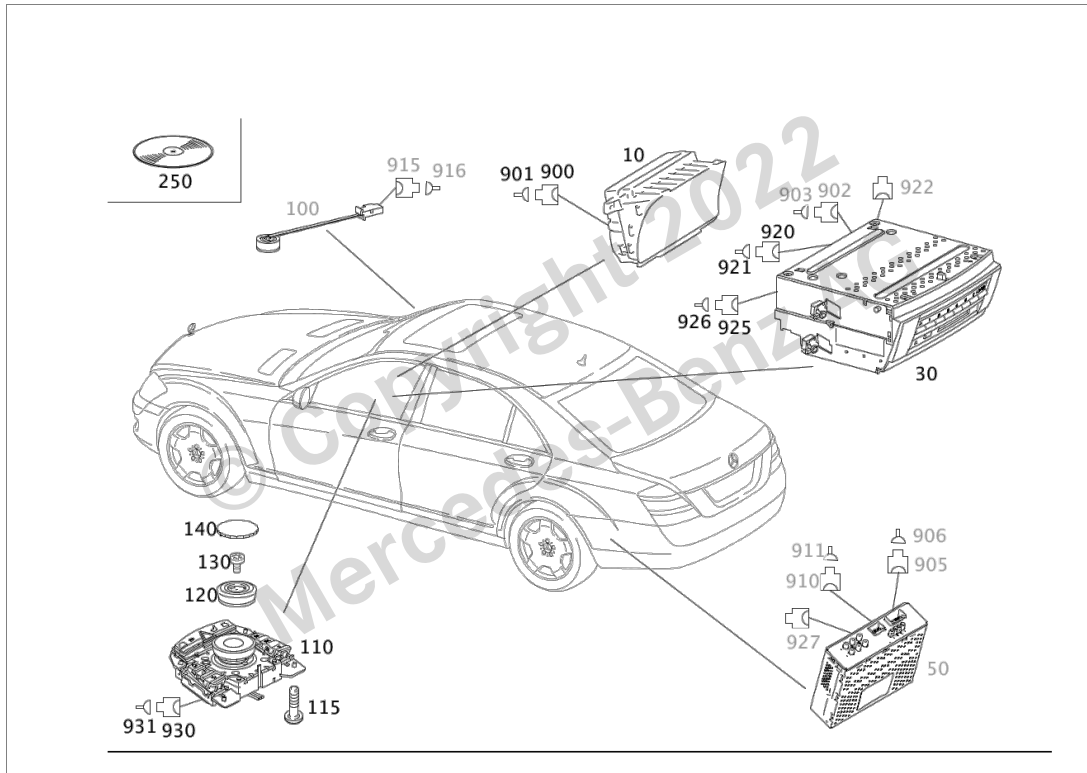

































Image ID: drawing\_B82325000046

Item	Part number	Designation/additional information	Qty
10	A 221 820 54 89	SCREEN CENTRAL DISPLAY [672] PART MUST BE CHECKED FOR CURRENT FLASHWARE AFTER INSTALLATION Replaced by: A 221 820 63 89 Replaced by: A 221 870 01 89 Replaced by: A 221 870 33 89 Replaced by: A 221 870 45 89	1
10	A 221 820 63 89	SCREEN CENTRAL DISPLAY; ZPD [672] PART MUST BE CHECKED FOR CURRENT FLASHWARE AFTER INSTALLATION Replaced by: A 221 870 01 89 Replaced by: A 221 870 33 89 Replaced by: A 221 870 45 89 Replaces: A 221 820 54 89	1
10	A 221 870 01 89	SCREEN CENTRAL DISPLAY; ZPD [672] PART MUST BE CHECKED FOR CURRENT FLASHWARE AFTER INSTALLATION Replaced by: A 221 870 33 89 Replaced by: A 221 870 45 89 Replaces: A 221 820 63 89 Replaces: A 221 820 54 89	1

Parts Information

Item	Part number	Designation/additional information	Qty
10	A 221 870 33 89  	SCREEN CENTRAL DISPLAY Replaced by: A 221 870 45 89 Replaces: A 221 870 01 89 Replaces: A 221 820 63 89 Replaces: A 221 820 54 89	1
10	A 221 870 45 89  	SCREEN CENTRAL DISPLAY  [672] PART MUST BE CHECKED FOR CURRENT FLASHWARE AFTER INSTALLATION Replaces: A 221 870 33 89 Replaces: A 221 870 01 89 Replaces: A 221 820 63 89 Replaces: A 221 820 54 89	1
30	A 221 870 87 86 	ELECTRONIC TRANSM. CU COMAND; TO A 230 820 35 89  [697, 672] PART IS ONLY OR ALSO SUPPLIED AS RECONDITIONED PART  Code: 527+814; Replaced by: A 221 870 86 92 Replaced by: A 221 870 06 93 Replaced by: A 221 870 80 93 Replaced by: A 221 870 30 95	1
30	A 221 870 86 92  	OPERATING UNIT COMAND  [525, 697] NOTE COND. RETURN VIA SYREK SETTLEMENT IN GERMANY. PLEASE ALSO ORDER AS REPLACEMENT PART.  Code: 527+814; Replaced by: A 221 870 06 93 Replaced by: A 221 870 80 93 Replaced by: A 221 870 30 95 Replaces: A 221 870 87 86	1
30	A 221 870 06 93 	OPERATING UNIT COMAND COMAND PLUS ECE M.NAVI  [525, 697] NOTE COND. RETURN VIA SYREK SETTLEMENT IN GERMANY. PLEASE ALSO ORDER AS REPLACEMENT PART.  Code: 527+814; Replaced by: A 221 870 80 93 Replaced by: A 221 870 30 95 Replaces: A 221 870 86 92 Replaces: A 221 870 87 86	1
30	A 221 870 80 93 	CONTROL UNIT, HEAD UNIT COMAND COMAND PLUS ECE M.NAVI  [525, 697] NOTE COND. RETURN VIA SYREK SETTLEMENT IN GERMANY. PLEASE ALSO ORDER AS REPLACEMENT PART.  Code: 527+814; Replaced by: A 221 870 30 95 Replaces: A 221 870 06 93 Replaces: A 221 870 86 92 Replaces: A 221 870 87 86	1
30	A 221 870 30 95  	OPERATING UNIT COMAND PLUS ECE M.NAVI  [525, 697] NOTE COND. RETURN VIA SYREK SETTLEMENT IN GERMANY. PLEASE ALSO ORDER AS REPLACEMENT PART.  Code: 527+814; Replaces: A 221 870 80 93 Replaces: A 221 870 06 93 Replaces: A 221 870 86 92 Replaces: A 221 870 87 86	1
110	A 221 870 75 58 	SWITCH BLOCK CONTROLLER  [672] PART MUST BE CHECKED FOR CURRENT FLASHWARE AFTER INSTALLATION  Code: 386/388/498/(M275+M60/M156+M63)+494; Replaced by: A 221 870 53 58	1

Parts Information

Item	Part number	Designation/additional information	Qty
110	A 221 870 53 58 	SWITCH BLOCK CONTROLLER  [672] PART MUST BE CHECKED FOR CURRENT FLASHWARE AFTER INSTALLATION  Code: 386/388/498/(M275+M60/M156+M63)+494; Replaces: A 221 870 75 58	1
115	N 000000 001687 	HEXALOBULAR BOLT SWITCH BLOCK TO ARMREST	4
120	A 221 827 00 25 	* ROTARY KNOB KNOB ON SWITCH BLOCK	1
130	N 000000 001496 	* HEXALOBULAR BOLT KNOB ON SWITCH BLOCK; M3X6	1
140	A 221 822 01 35 	* ROTARY KNOB SWITCH BLOCK TO ARMREST	1
250	A 221 827 00 59	DVD-ROM COMAND DVD APS WITH NAVIGATION  [525] NOTE COND. RETURN VIA SYREK SETTLEMENT IN GERMANY. PLEASE ALSO ORDER AS REPLACEMENT PART.  Code: 527;	1
250	A 221 827 54 59	DVD-ROM NTG3  Code: (512/527)+5XXL+-800;	1
250	A 221 827 68 59	DVD-ROM NTG 3  Code: 527+(2XXL/5XXL); Replaced by: A 221 827 03 65 Replaced by: A 221 827 11 65	1
250	A 221 827 03 65	DVD-ROM NTG 3  Code: 527+(2XXL/5XXL); Replaced by: A 221 827 11 65 Replaces: A 221 827 68 59	1
250	A 221 827 11 65	DVD-ROM NTG 3  Code: 527+(2XXL/5XXL); Replaces: A 221 827 03 65 Replaces: A 221 827 68 59	1
250	A 216 827 35 59	DVD-ROM NTG 3.5  [402] NO LONGER AVAILABLE  Code: (527/527+814)+(2XXL/5XXL); Replaced by: A 216 827 36 59 Replaced by: A 216 827 38 59 Replaced by: A 216 827 47 59 Replaced by: A 216 827 53 59 Replaced by: A 216 827 61 59	1
250	A 216 827 36 59	DVD-ROM NTG 3.5  [402] NO LONGER AVAILABLE  Code: (527/527+814)+(2XXL/5XXL); Replaced by: A 216 827 38 59 Replaced by: A 216 827 47 59 Replaced by: A 216 827 53 59 Replaced by: A 216 827 61 59 Replaces: A 216 827 35 59	1

Parts Information

Item	Part number	Designation/additional information	Qty
250	A 216 827 38 59	DVD-ROM NTG 3.5 📄 [402] NO LONGER AVAILABLE 📦 Code: (527/527+814)+(2XXL/5XXL); Replaced by: A 216 827 47 59 Replaced by: A 216 827 53 59 Replaced by: A 216 827 61 59 Replaces: A 216 827 36 59 Replaces: A 216 827 35 59	1
250	A 216 827 47 59	DVD-ROM NTG 3.5 📦 Code: (527/527+814)+(2XXL/5XXL); Replaced by: A 216 827 53 59 Replaced by: A 216 827 61 59 Replaces: A 216 827 38 59 Replaces: A 216 827 36 59 Replaces: A 216 827 35 59	1
250	A 216 827 53 59	DVD-ROM NTG 3.5 📦 Code: (527/527+814)+(2XXL/5XXL); Replaced by: A 216 827 61 59 Replaces: A 216 827 47 59 Replaces: A 216 827 38 59 Replaces: A 216 827 36 59 Replaces: A 216 827 35 59	1
250	A 216 827 61 59	DVD-ROM NTG 3.5 📦 Code: (527/527+814)+(2XXL/5XXL); Replaces: A 216 827 53 59 Replaces: A 216 827 47 59 Replaces: A 216 827 38 59 Replaces: A 216 827 36 59 Replaces: A 216 827 35 59	1
900	A 002 540 75 81	SOCKET CENTRAL DISPLAY A40/8; 8-PIN MQS	1
901	A 016 545 41 26	CONTACT SOCKET CENTRAL DISPLAY A40/8; 0.25-0.5 MM2 MQS	NB
920	A 168 545 09 28	COUPLING HOUSING, ELEC. COMAND A40/3; 40-PIN MQS	1
921	A 016 545 41 26	CONTACT SOCKET COMAND A40/3; 0.25-0.5 MM2 MQS	NB
925	A 002 545 86 40	HOUSING COMAND A40/3; 20-PIN	1
925	A 000 545 90 30	HOUSING COMAND A40/3; 22-PIN MQS	1
926	A 016 545 41 26	CONTACT SOCKET COMAND A40/3; 0.25-0.5 MM2 MQS	NB
926	A 020 545 10 26	CONTACT SOCKET COMAND A40/3; P717	NB
930	A 002 540 75 81	SOCKET CONTROLLER A40/9; 8-PIN MQS	1
931	A 016 545 41 26	CONTACT SOCKET CONTROLLER A40/9; 0.25-0.5 MM2 MQS	NB
931	A 000 540 46 05	ELECTRIC LINE CONTROLLER A40/9; 0.75 MM2 MQS SN 📄 [T774] CONNECTORS MUST ALSO BE ORDERED IN ACC. WITH THE TOTAL CABLE CROSS-SECTION TO BE CONNECTED. SEE WIS FOR REPAIR INSTRUCTIONS. =====	NB
<p>SOLDER CONNECTOR SLEEVES: TOTAL WIRE CROSS-SECTION: A 001 546 99 41 GREEN 0.7 - 2.4 MM2 A 002 546 00 41 RED 2.0 - 4.0 MM2 A 002 546 01 41 BLUE 3.5 - 8.0 MM2 A 002 546 11 41 YELLOW 7.5 - 12.0 MM2 BUTT JOINT: A 002 546 13 41 0.5 MM2 A 002 546 14 41 0.8 MM2 A 002 546 15 41 1.3 MM2 A 002 546 16 41 2.0 MM2</p> <p>=====</p>			

