

Model 222  
as of model year 2018

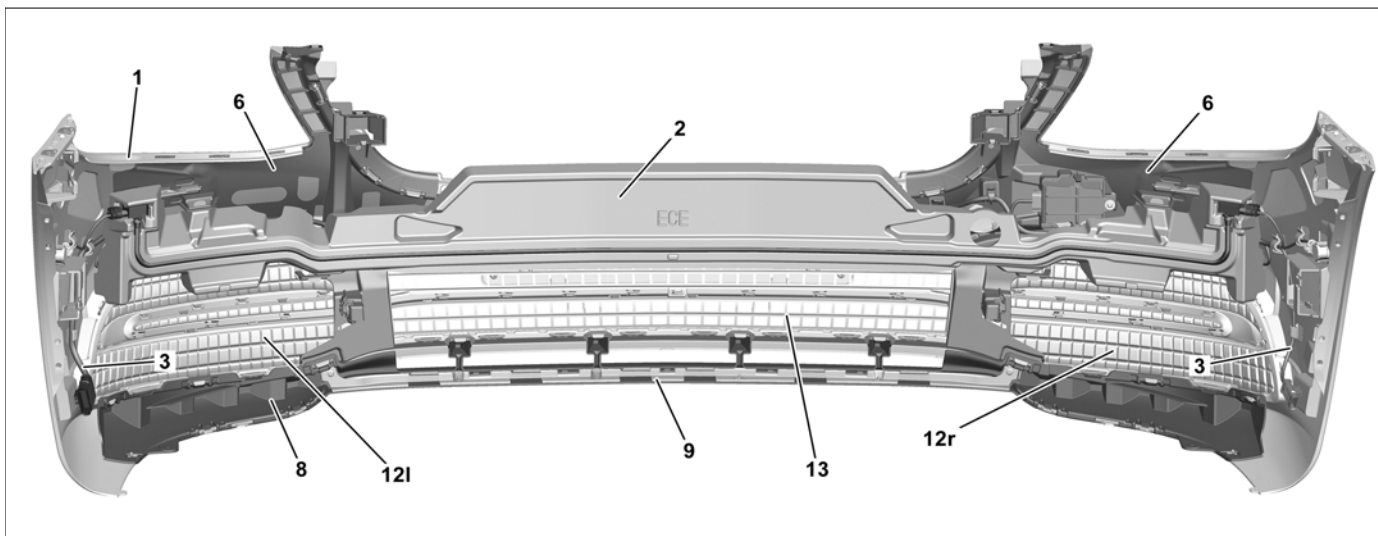

P88.20-4814-08

Shown on model 222.0 with engine 256, with code U60 (Active hood (Pedestrian protection)), with code 235 (Active Parking Assist with PARKTRONIC) and with code 258 (COLLISION PREVENTION ASSIST)

- |   |                                   |     |                   |
|---|-----------------------------------|-----|-------------------|
| 1 | Front bumper                      | 9   | Reinforcement     |
| 2 | Impact absorber                   | 12l | Left cover        |
| 3 | Electrical wiring harness         | 12r | Right cover       |
| 6 | Basic carrier                     | 13  | Center air grille |
| 8 | Center lower bumper basic bracket |     |                   |

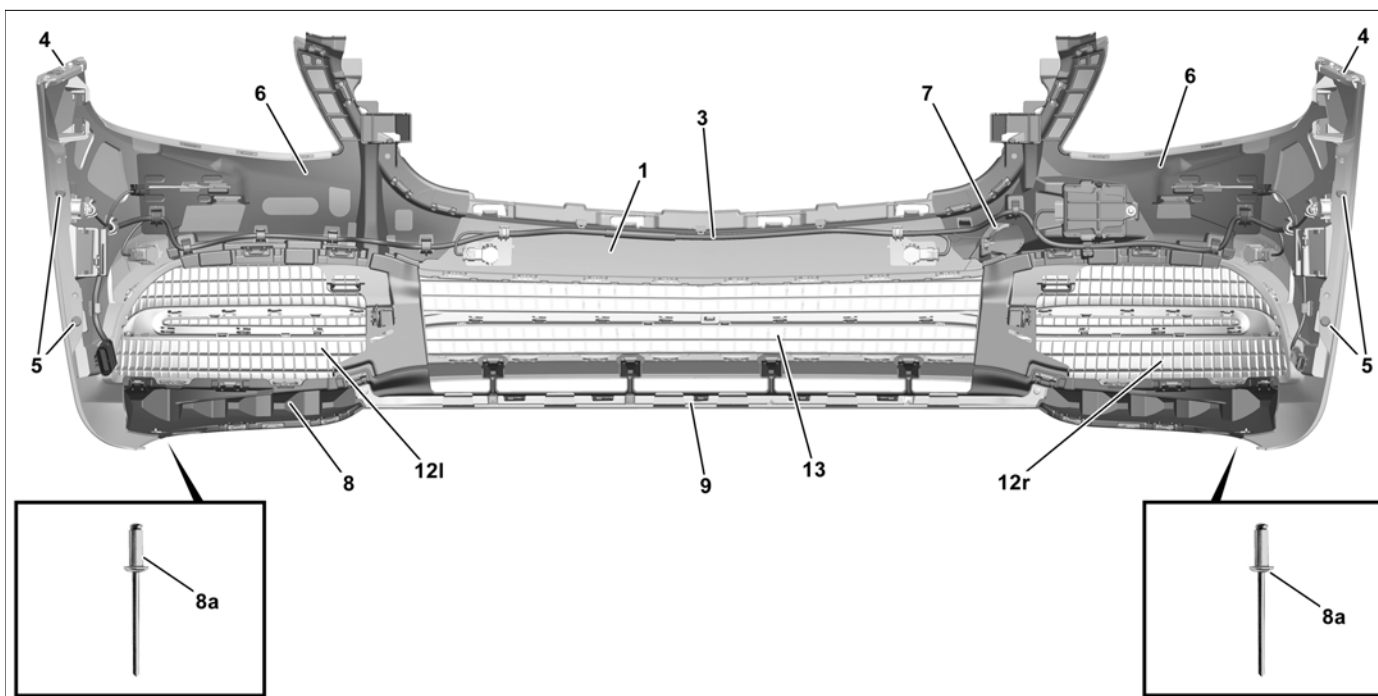

P88.20-4815-09

Shown on model 222.0 with engine 256, with code U60 (Active hood (Pedestrian protection)), with code 235 (Active Parking Assist with PARKTRONIC) and with code 258 (COLLISION PREVENTION ASSIST)

- |   |                           |    |                                   |
|---|---------------------------|----|-----------------------------------|
| 1 | Front bumper              | 8  | Center lower bumper basic bracket |
| 3 | Electrical wiring harness | 8a | Rivet                             |

- 4 Reinforcing bar
- 5 Expansion rivet
- 6 Basic carrier
- 7 Tow hook cover

- 9 Reinforcement
- 12l Left cover
- 12r Right cover
- 13 Center air grille

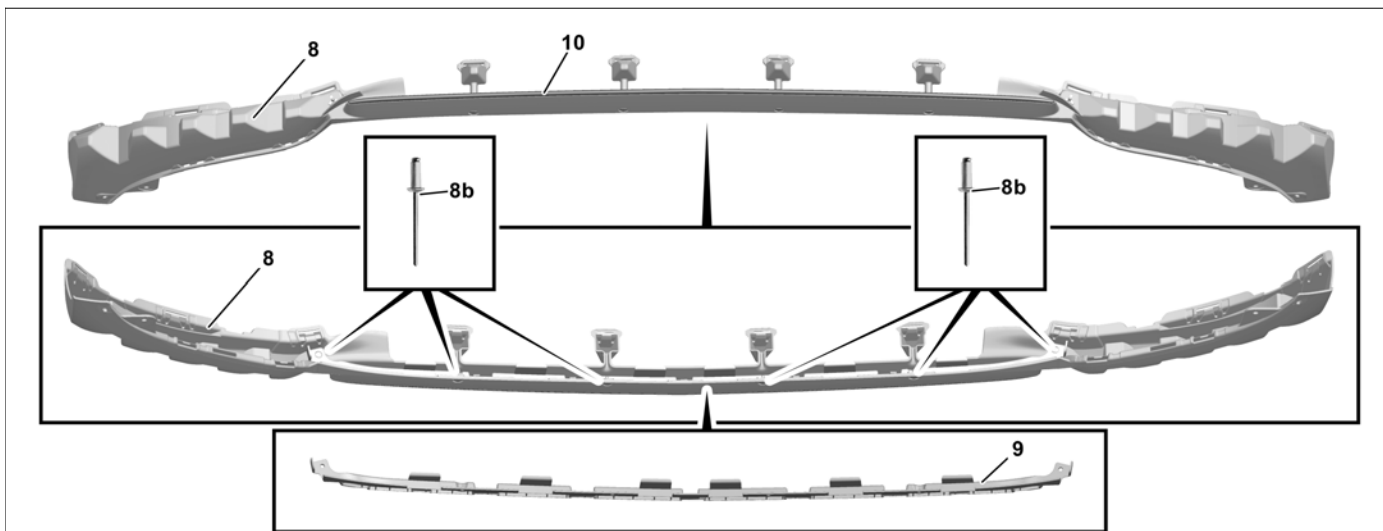

P88.20-4816-08

- 8 Center lower bumper basic bracket
- 8b Rivet

- 9 Reinforcement
- 10 Lower trim piece

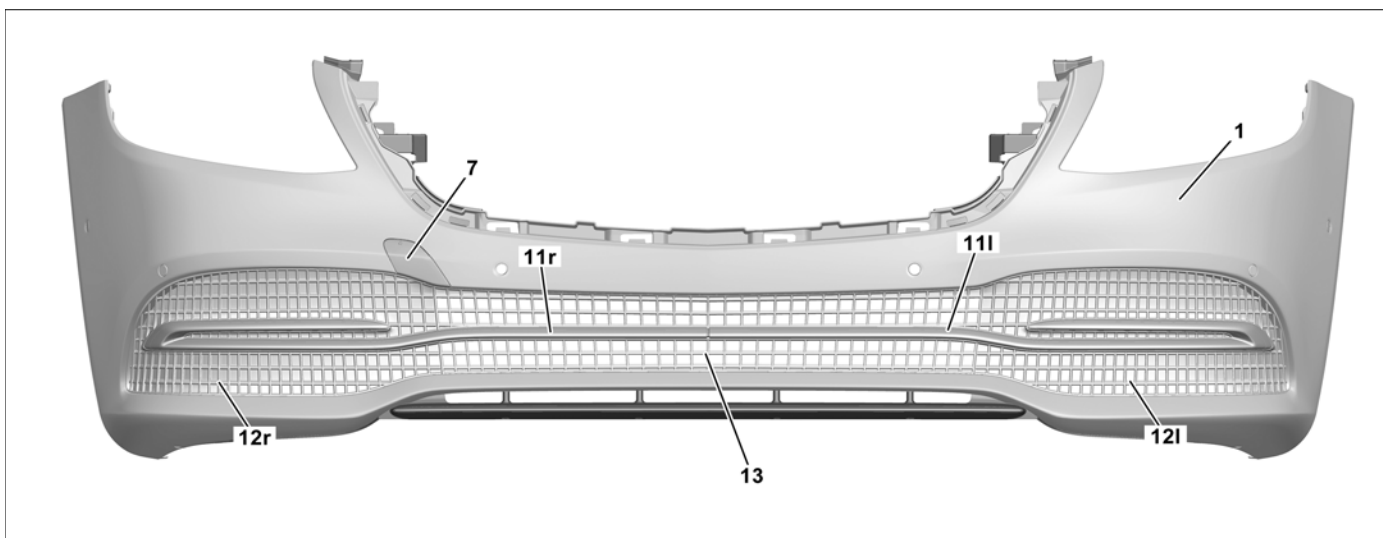

P88.20-4817-08

**Shown on model 222.0 with engine 256, with code U60 (Active hood (Pedestrian protection)) and with code 235 (Active Parking Assist with PARKTRONIC)**

- 1 Front bumper
- 7 Tow hook cover
- 11l Left trim piece
- 11r Right trim piece

- 12l Left cover
- 12r Right cover
- 13 Center air grille

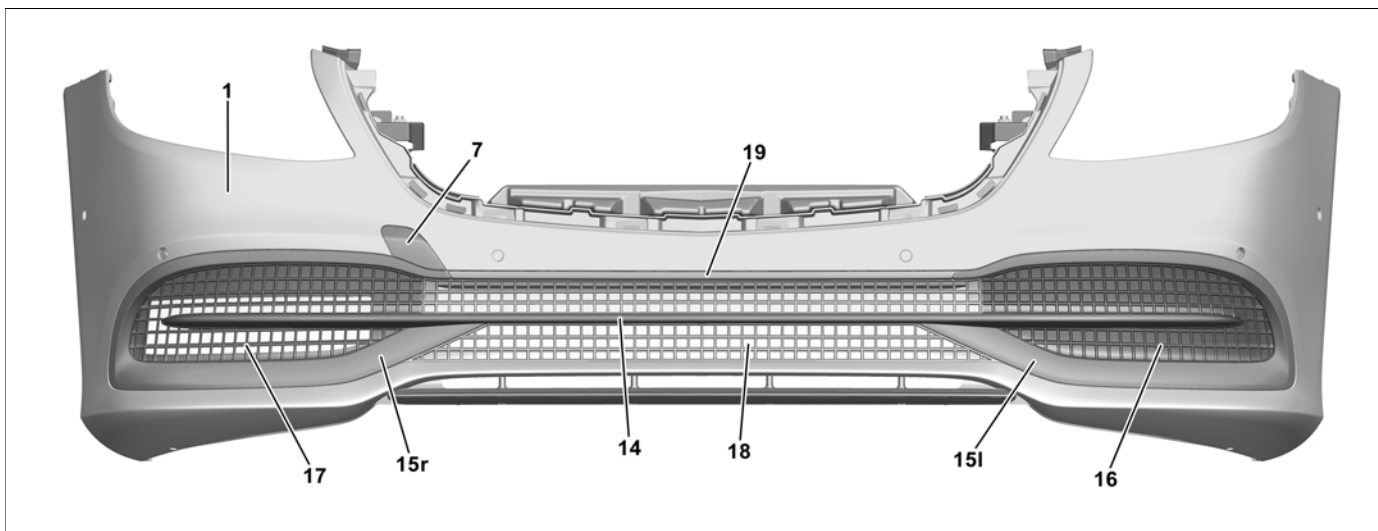

















P88.20-4818-08

Shown on model 222.9 with engine 279 and with code 235 (Active Parking Assist with PARKTRONIC)

- |     |                           |    |                           |
|-----|---------------------------|----|---------------------------|
| 1   | Front bumper              | 16 | Left cover                |
| 7   | Tow hook cover            | 17 | Right air grille          |
| 14  | Lower center trim element | 18 | Center air grille         |
| 15l | Left outer trim element   | 19 | Upper center trim element |
| 15r | Right outer trim element  |    |                           |

Caution	<b>Risk of injury</b> caused by scraping or cutting body parts on sharp vehicle parts	Always wear protective gloves when working on or near sharp and non-deburred vehicle parts. Deburr repair panels.	AS00.00-Z-0017-01A
	<b>Remove</b>		
1	Remove front bumper (1)		AR88.20-P-2000LF
	<b>Disassemble/assemble</b>		
2	Remove license-plate number		
3	Remove license plate bracket		
4	Remove pedestrian protection sensor  Notes on pedestrian protection sensor	Model 222 as of model year 2018 with code U60 (Active Bonnet (Pedestrian protection))	AH91.60-P-0001-01A AR91.60-P-0950EWM
5	Remove impact absorber (2) General information on the impact absorber		AH88.20-P-1000-01A
6	Remove sensors from PARKTRONIC system (PTS)	Model 222 as of model year 2018 with code 235 (Active Parking Assist with PARKTRONIC)	AR54.65-P-0001LF
7	Remove radar sensor	Model 222 as of model year 2018 with code 258 (COLLISION PREVENTION ASSIST)	AR30.30-P-1210LFM
8	Detach electrical wiring harness (3) from front bumper (1) and remove	Electrical wiring harness (3) varies depending on the vehicle equipment.	
9	Remove left reinforcing bar (4)	Mounting wedge	*110589035900
10	Remove right reinforcing bar (4)	Mounting wedge	*110589035900
11	Remove expansion rivet (5)		
12	Remove left basic bracket (6)	Left basic bracket (6) consists of two single parts. Remove single parts together. Mounting wedge	*110589035900
13	Remove right basic bracket (6)	Right basic bracket (6) consists of two single parts. Remove single parts together.	

		 Mounting wedge	*110589035900
14	Remove tow hook cover (7)		
15	Drill out rivets (8a)		
16	Remove center lower bumper basic bracket (8) together with reinforcement (9) and lower trim element (10)	 Mounting wedge	*110589035900
17	Drill out rivets (8b)		
18	Remove reinforcement (9) from center lower bumper basic bracket (8)	 Mounting wedge	*110589035900
19	Remove lower trim element (10) from center lower bumper basic bracket (8)	 Mounting wedge	*110589035900
20.1	Remove right trim element (11r) and left trim element (11l)	Model 222.0/1 as of model year 2018  <b>Removal:</b> Start with right trim element (11r).  Mounting wedge	*110589035900
20.2	Remove lower center trim element (14), left outer trim element (15l) and right outer trim element (15r)	Model 222.9 as of model year 2018  <b>Removal:</b> Start with lower center trim element (14).  Mounting wedge	*110589035900
21.1	Remove left cover (12l) and right cover (12r)	Model 222.0/1 as of model year 2018  Model 222.0/1 with engine 176 as of model year 2018 Model 222.1 with engine 277 as of model year 2018 An air grille is installed instead of right cover (12r).  Mounting wedge	*110589035900
21.2	Remove left cover (16) and right air grille (17)	Model 222.9 as of model year 2018  Model 222.9 with engine 256 as of model year 2018 Model 222.9 with engine 276 as of model year 2018 Model 222.9 with engine 278 as of model year 2018 A cover is installed instead of right air grille (17).  Mounting wedge	*110589035900
22.1	Remove center air grille (13)	Model 222.0/1 as of model year 2018  Mounting wedge	*110589035900
22.2	Remove center air grille (18) together with upper center trim element (19)	Model 222.9 as of model year 2018  Mounting wedge	*110589035900
23	Remove upper center trim element (19) from center air grille (18)	Model 222.9 as of model year 2018  Mounting wedge	*110589035900
24	Assemble in the reverse order		
	<b>Install</b>		
25	Install front bumper (1)		AR88.20-P-2000LF

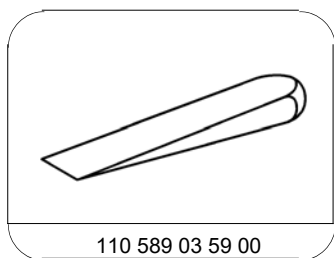

110 589 03 59 00

Mounting wedge