



# Table of Contents

1	<a href="#">General Information</a>
2	<a href="#">What's New</a>
3	<a href="#">Models</a>
4	<a href="#">Equipment</a>
4.1	<a href="#">Standard Equipment</a>
4.2	<a href="#">Exterior Paint Colors</a>
4.3	<a href="#">Wheels</a>
4.4	<a href="#">Interior Upholstery</a>
4.6	<a href="#">Interior Trims</a>
4.7	<a href="#">Packages</a>
4.8	<a href="#">Options</a>
4.9	<a href="#">Specifications</a>
5	<a href="#">Options In Detail</a>
6	<a href="#">Gallery</a>



# General Information

## Important Note

The information presented in this guide is based on the most current information available and is intended for internal use only. Mercedes-Benz reserves the right to make changes at any time, without notice, to colors, materials, equipment, special specifications and models.

Pricing may not yet be finalized for some models or options.

Due to variances among monitors and printers the colors that appear on your screen and printouts may not be exact.

For illustrative purposes, some images may show vehicles with European Specification.

## Revision History

Date	Description
12/20/2021	Publish MY22 S680 4MATIC DOG
11/09/2021	Update: <b>R57-19" Maybach Exclusive 5-Spoke Wheel has been replaced by R39-Maybach Exclusive 5-Spoke Wheel</b>
10/26/2021	Update: <b>Two-Tone Paint C29- Onyx Black/ Mojave Silver not available to order due to limited availability</b>
10/25/2021	Update: As you are aware, MBUSA is experiencing challenges with the availability of semiconductor components due to the worldwide shortage. This has caused the addition and/or removal of certain options on vehicles. A summary of the changes is below: <b>AIR BALANCE (P21) limited availability for the remainder of MY22.</b>
05/18/2021	Addition of 519- Crystal White and Silver Grey Pearl Upholstery



# What's New

S580Z4



## Paints

- Cirrus Silver Upper / Nautical Blue Lower
- Kalahari Gold Upper / Onyx Black Lower
- MANUFAKTUR Selenite Grey Magno
- Nautical Blue
- Kalahari Gold Upper / Rubellite Red Lower
- MANUFAKTUR Cashmere White Magno
- MANUFAKTUR Kalahari Gold

## Upholstery

- MANUFAKTUR Crystal White & Silver Grey Pearl

## Options

- E- Active Body Control

S680Z4



## Paints

- Cirrus Silver Upper / Nautical Blue Lower
- Kalahari Gold Upper / Onyx Black Lower
- MANUFAKTUR Selenite Grey Magno
- Nautical Blue
- Kalahari Gold Upper / Rubellite Red Lower
- MANUFAKTUR Cashmere White Magno
- MANUFAKTUR Kalahari Gold

## Upholstery

- MANUFAKTUR Crystal White & Silver Grey Pearl

## Standard Equipment

- MBUX Interior Assistant Front and Rear

## Paints

- 595- Nautical Blue
- 041- designo® Manufaktur Cashmere White Magno
- 802- Kalahari Gold
- 297- designo® Manufaktur Selenite Grey Magno

## 2-Tone Paint

- C27-Kalahari Gold Upper / Rubellite Red Lower
- C32-Kalahari Gold Upper / Onyx Black Lower
- C28-Cirrus Silver Upper / Nautical Blue Lower

## Options



## Rear-Axle Steering With 4.5° (Standard)

The rear-axle steering with steering angle adjustment of 4.5° offers three key advantages: even more superior roadholding, significantly enhanced agility and, last but not least, better manoeuvrability – such as when parking. For this, the rear wheels steer in the opposite or the same direction as the front wheels depending on the vehicle speed.



- Four speed-dependent steering strategies:
  - Parking with a reduced turning circle (steering angle of up to 4.5° in the opposite direction to the front axle)
  - City manoeuvrability (steering angle of up to 4.5° in the opposite direction to the front axle), active up to approx. 60 km/h
  - Top speed stabilisation (steering angle of up to 2.5° in the same direction as the front axle)
  - Increase in driving dynamics (steering angle of up to 3° in the same direction as or opposite direction to the front axle depending on driving situation), active from approx. 60 km/h, controlled by the dynamic handling control system integrated into the ESP®
- Snow chain mode for adapted actuation of the rear axle steering in wintry conditions
- Representation of the rear axle steering in the central display
  - Display of the current rear axle steering angle
  - Overlay of current track circle when parking
- Rear axle steered via an electromechanical central actuator with trapezoidal screw thread

Available with 53R-Maybach Monoblocks Forged Wheel and 70R-21" Multispoke "Flute" Wheel

## Rear-Axle Steering With 10° (Standard)

Experience the claim to leadership of Mercedes-Benz even when parking: this rear axle steering adjusts the steering angle by up to 10° and reduces the turning circle by almost two metres. As such your S-Class almost handles like a compact car when manoeuvring. At higher speeds, on the other hand, you drive with the effortless superiority afforded by the long wheelbase.

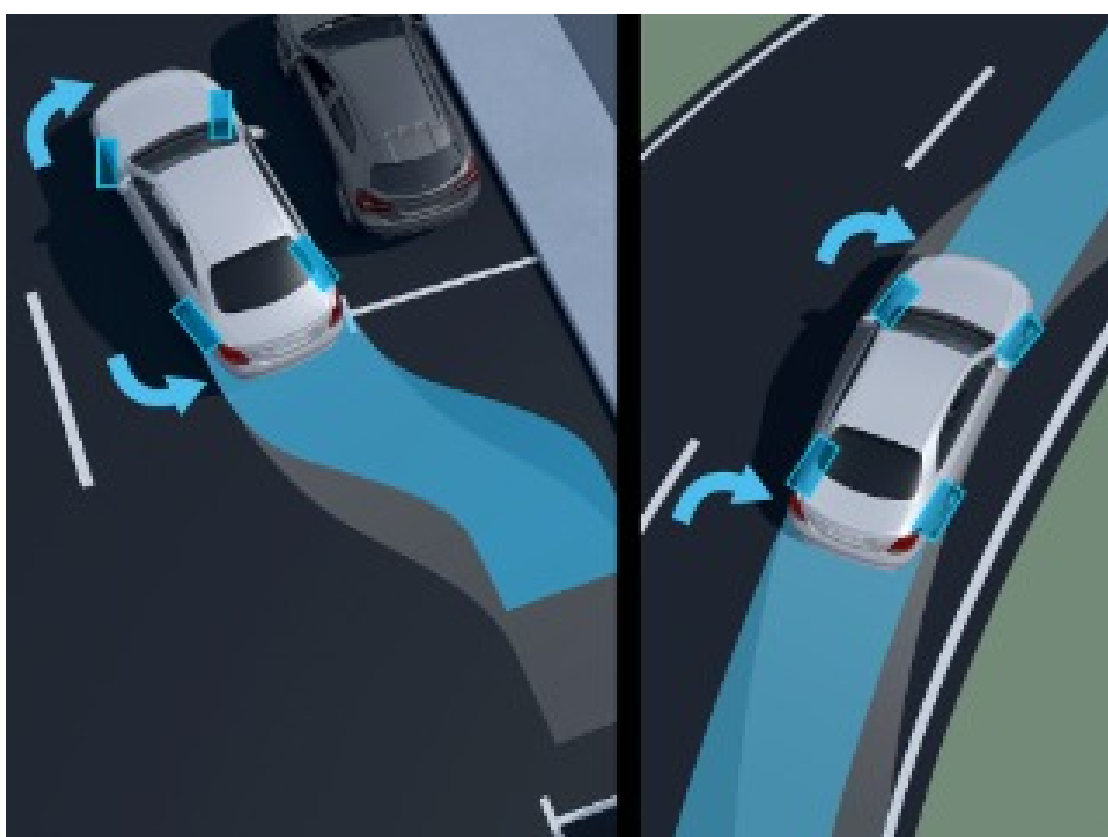

- Speed-dependent steering strategies:
  - Parking with a more reduced turning circle (steering angle of up to 10° in the opposite direction to the front axle) by almost two metres
  - City manoeuvrability (steering angle of up to 4.5° in the opposite direction to the front axle), active up to approx. 60 km/h
  - Top speed stabilisation (steering angle of up to 2.5° in the same direction as the front axle)
  - Increase in driving dynamics (steering angle of up to 3° in the same direction as or opposite direction to the front axle depending on driving situation), active from approx. 60 km/h, controlled by the dynamic handling control system integrated into the ESP®
- Snow chain mode for adjusted actuation of the rear axle steering in wintry conditions with a maximum rear axle steering angle of 4.5°
- Showcasing of the rear axle steering in the central display
  - Display of the current rear axle steering angle
  - Overlay of current track circle when parking
- Rear axle steered via an electromechanical central actuator with trapezoidal screw thread

Available with R57-19" Maybach Exclusive 5-Spoke Wheel and R61-20" Maybach Monoblocks Forged Wheel



# Adaptive Rear Lighting

## (Standard)

Whether reading a book or working on your laptop: you can adjust the brightness and colour temperature of the interior lighting according to your taste and how you are feeling. You can also direct individual LED spotlights to your preferred position. Twinkling adaptive rear light strips complement the light functions and increase light quality.

- Spotlights via LED matrix lights in both grab handles in the rear with individually controllable LEDs
- Interior light via LED rear light strips as additional lighting in the roof lining
- Position and size of the spotlight as well as brightness and colour temperature can be individually set
- Light functions:
  - Interior light as down light, mood light or interior light
  - Spotlight on both the left and right rear as a reading light, work light or individual light
- 2 buttons in the grab handles active the reading light or one of your favourite light functions (star symbol)
- Additional control options via the MBUX rear tablet (447) or MBUX High End Rear Entertainment (854)



# Rear Passenger Airbag (302)

## (Standard)

Innovative air cushions make your rear passenger compartment even safer. The rear airbags are integrated into the backrests of the front seats and deploy in a severe front impact. They unfold gently and protect strapped-in outer rear seat passengers against contact with the seats. This reduces the load on the head and neck significantly.

For this, gas stored under pressure inflates cylindrical tubes. They form the outer framework. Ambient air fills the space in between via patented valves and remains enclosed there. This creates an airbag cushion into which the passengers are immersed.

This concept takes into account the adjustable front seat backrests, the space conditions in the rear plus the different seating positions of adults or children. The tubular wings avoid obstacles such as child seats, enabling the load to be channeled past them.

## Key Facts:

- One airbag each in the front seat backrests, deploy in the event of a severe front impact
- Innovative deployment and inflation concept – outer tube structures inflated by compressed gas and an airbag in between filled with compressed ambient air
- Stabilizes strapped-in outer rear seat passengers and can protect them against a possible impact with the front seats, loads on head and neck can be reduced significantly
- Gentle deployment of the airbag and thus reduced risk of injury – channels the tube structure past obstacles such as child seats, thus reducing the effect of the force

# New Engine: S580 M176 V8 Engine

8-cylinder V-engine with 90° cylinder bank angle

Displacement: 3982 cc

Output: 496 hp

Torque: 516 lb-ft at 2000-4000 rpm

Stroke: 92 mm; Bore: 83 mm

Cylinder gap width: 90 mm



- 4-valves-per-cylinder design with two overhead camshafts per cylinder bank; camshaft adjustment on the intake and exhaust sides for spontaneous response, optimised load change behaviour and maximum durability
- Cylinder shut-off (CAMTRONIC) for fuel consumption reduction in partial-load range
- NANOSLIDE® (twin-wire-arc-sprayed) coating of cylinders for low friction and wear as well as maximum durability
- Torque plate honing for mechanical surface treatment of the cylinder sleeves in the "bolted state" to reduce consumption and friction
- Twin-turbocharging with two exhaust gas turbochargers between the two cylinder banks instead of exterior arrangement for compact engine design, optimum response and low exhaust gas emissions
- Mono-scroll exhaust gas turbocharger with boost pressure control via boost-pressure regulating valve for direct and spontaneous exhaust gas turbocharger response
- Spray-guided direct petrol injection of the 3rd generation with piezo injectors and demand-controlled multiple injection for high thermal efficiency and low emissions
- Separate low-temperature circuit for the charge air cooler to achieve optimum power output
- Efficient ancillary component drive via two short low-friction four-groove belt; water pump with chain drive
- Two-mass flywheel with centrifugal pendulum isolates the drivetrain from torsional vibration and supports excellent smoothness of operation
- Integrated starter alternator ISG2 (second generation)



# Mercedes-Benz User Experience (Standard)



## Extended MBUX Functions:

Say "Hey Mercedes", and your MBUX system awaits your commands. Personal profiles, predictive functions and a WiFi hotspot completely redefine the term digital networking

## Many forms of interaction and personalization from every seat:

- The latest screen technologies and MBUX available for all occupants
- Standard 12.8" OLED Touchscreen Media display in portrait format as a visual highlight; features haptic feedback
- Up to three screens in the rear with the available Executive Line
- Up to seven different profiles are possible in the vehicle.
- Alongside entry of the Mercedes me PIN, new biometric and interconnected authentication functions ensure a high level of security. These are fingerprint (standard), face (optional with 3D Technology Package) and voice recognition (standard).
- New convenience functions include prepositioning of the driver's seat and outside mirrors according to body size
- The voice assistant "Hey Mercedes" listens even more carefully, and understands the occupants even better: "Hey Mercedes" can also be controlled from the rear. Several microphones help to tell the system which seat the voice is coming from. Flashing ambient lighting identifies the current speaker
- "Hey Mercedes" explains functions. The activation keyword "Hey Mercedes" is no longer necessary for certain applications. An incoming call can be taken direct with "Accept call", for example
- The appearance of the screens can be individualized with a choice of four display styles (Understated, Sporty, Exclusive, Classic) and three modes (Navigation, Assistance, Service)
- The number of classic controls has been greatly reduced: 27 fewer hardkeys (mechanical switches) than in the preceding model
- However, key functions such as the lights or windscreen wipers can still be operated directly. The climate control panel is permanently at the lower edge of the display

## 12.8" Central OLED Touchscreen (Standard)



### OLED Technology: OLED stands for Organic Light Emitting Diode.

In contrast to LCD technology, an OLED display consists of several organic layers applied to a plastic substrate. In the S-Class the OLED display is located behind a glass facing, and in combination with the actuators and pressure sensors behind it, it provides a comprehensive control and display experience. Evaluation of the pressure exerted and haptic confirmation of touch commands makes extended functionalities possible.

OLED panels emit light when subjected to an electric current, and unlike an LCD they do not require external background lighting. Power is only consumed where pixels light up. Among other benefits, this ensures a better black level and even stronger contrasts. When showing typical video sequences, OLED technology has an up to 30 percent lower energy consumption than LCD technology.

# Driver Assistance Package (Standard)



The standard Driver Assistance Package features Level 2 automated driving. State-of-the-art driving assistance systems support the driver according to the situation in terms of speed adjustment, steering, lane changes and the risk of collision. The risk of accidents is reduced – passengers and other road users are effectively protected.

Drivers are afforded a great degree of relief in monotonous traffic during lengthy trips, for example, and in bumper-to-bumper driving or traffic jams as well as before curves, roundabouts, T-junctions and the end of traffic jams, etc.

The fusion of different radar, ultrasound and camera sensors, map and navigation data, and live traffic information gives the customer more functionality compared to standard/individual functions.

## The Driver Assistance Package Includes:

- Active Distance Assist DISTRONIC
- Active Speed Limit Assist with response to changing speed limits
- Extended automatic restarting
- Route-based speed adaptation
- Active Steering Assist
- Active Lane Change Assist
- Active Emergency Stop Assist
- Evasive Steering Assist
- Active Blind Spot Assist with exit warning
- Active Brake Assist with turning and cross-traffic function
- End-of-Tailback Emergency Braking
- PRE-SAFE® Impulse Side

### Active Lane Change Assist

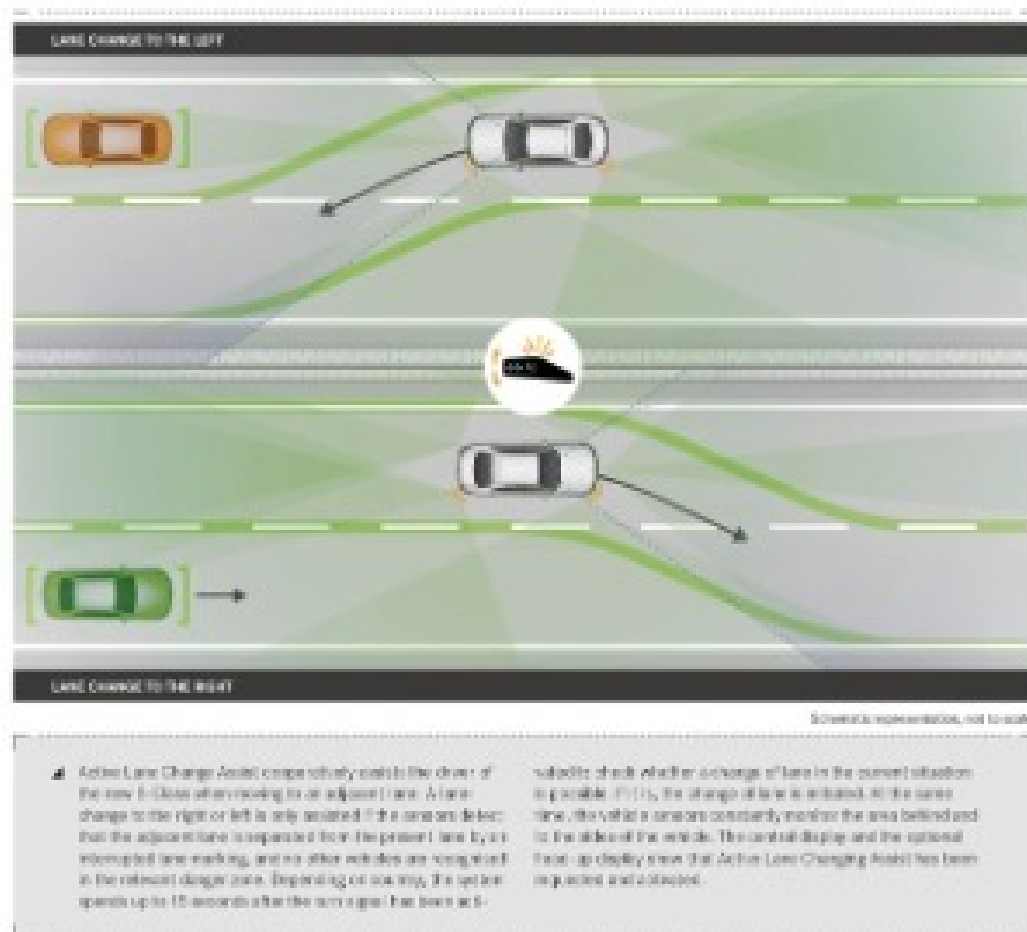

## Dashcam (Standard)

The dashcam films and saves what's happening on the road in front of your vehicle – and also records the time and speed. This can help you document the sequence of events in an accident, for example, and provide you with supporting evidence if necessary. Or you can use the dashcam to record landscapes and routes to create your own automotive travel diary.

### Components:

- Camera in the windshield
- Recording of videos with a resolution of 1280 x 720 pixels (720p) and a frame rate of 30 Hz
- Additional storage of speed and time embedded in the video signal
- Control menu in the media display
- Footage stored via USB stick using the Media Interface
- Video material can be viewed on a computer or the media display (only possible when vehicle is stationary) - for this the storage media must first be removed from the interface and reconnected



## Active Ambient Lighting (Standard)

### Key Argument:

With the active ambient lighting you are experiencing a technological leap. It links aesthetics with innovative driver information and extended functions. Wraparound light strips and trim elements meld to form an additional lighting level. This also supports driving assistance systems visually, thus emphasizing the intelligence and safety of your vehicle.

### Components:

- Ambient lighting in 64 static colors, all colors can be selected individually
- High-quality Black-Panel light strip with a total of approx. 250 integrated and individually actuatable LEDs
- Diverse color moods, also with static or multicolor animated color sequences
- Driving assistance systems are also included and are supported visually
  - Active Blind Spot Assist
  - Active Lane Keeping Assist
  - Active Brake Assist
- Emotively appealing animations: welcome display or feedback in color when adjusting the air conditioning or interaction with the voice control
- Incorporation of active ambient lighting into the programs of the ENERGIZING comfort control (only in conj. with ENERGIZING packages)
- Variable setting of the brightness for automatic day and night switchover

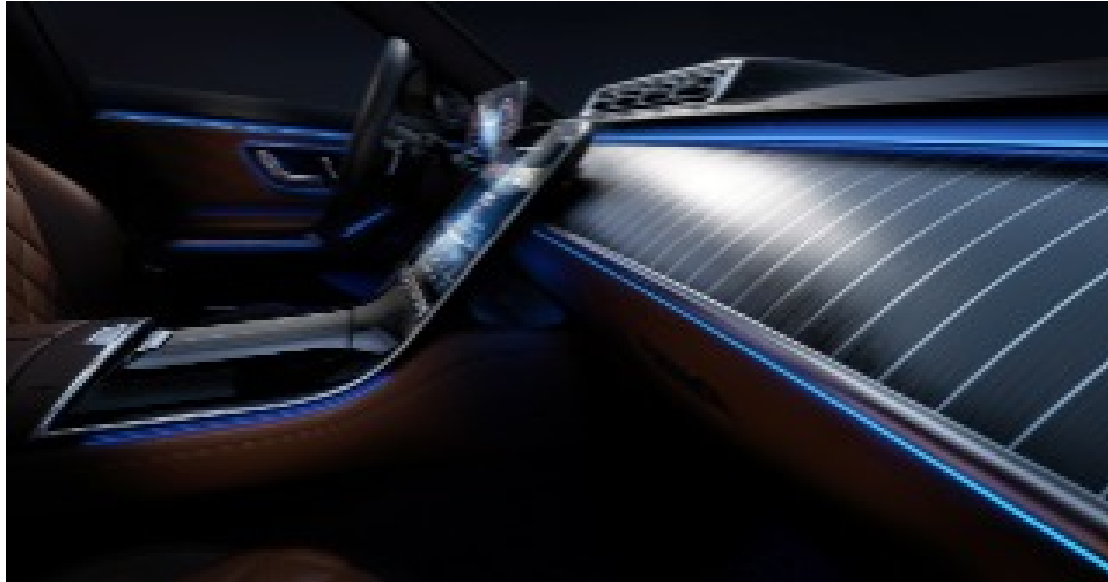

## Wireless Smartphone Integration - Apple Carplay, Android Auto™ - (Standard)



Smartphone Integration connects the mobile phone with the multimedia system wirelessly via Apple CarPlay™ and Android Auto™. This gives you convenient access to the most important applications of your smartphone. You can also use apps from third party service providers such as Spotify quickly and easily.

## Keyless GO with Seamless Door Handles (Standard)



KEYLESS-GO puts an end to searches for the vehicle key. As soon as the convenience system detects your key in the immediate vicinity of the vehicle, the Seamless Door Handles automatically extend. When you drive off or lock the doors, they retract and are elegantly integrated into the side design – a clear technical and visual advantage for you.

# Burmester® 4D Surround Sound System (Standard)

You feel the music. So-called resonators – experts call them structure-borne sound transducers – vibrate and pulsate in synch with the rhythms. This opens up a 4th dimension to you, intensifies your enjoyment of the music and relaxes you, all at the same time.



- 30 High-End speakers incl. subwoofer + 8 resonators (structure-borne sound transducers) in the seats, all with their own amplifier channel
- Amplifier with digital and analogue filters and output of 1350 watts for natural, warm and at the same time solid sound
- Additional amplifier with an output of 400 watts for subwoofer bass speaker (18.5-litre volume) in the boot
- 2 broadband speakers in the upper backrest area of each front seat, their position close to the ear also optimises the quality of telephony (Driver Mode)
- 6 broadband speakers (3D sound) distributed across the overhead control panel, the roof cluster between the front and rear seat rows and the sides behind the B-pillars
- 2 resonators in the backrest of each front seat and outer rear seat (technically like a speaker without a membrane) vibrate and pulsate in synch with the music
- 2 bass speakers integrated in the bodyshell (Frontbass technology), the driver and front-passenger footwells
- 1 bass speaker in each door
- 7 mid-range speakers (one in each door, one centrally on the dashboard, two on the parcel shelf)
- 7 tweeters (in the front in the mirror triangle – integrated and extending, combined with ambient lighting – one in each of the rear doors, one centrally on the dashboard, two on the parcel shelf)
- Personalisation function for sound reproduction tuned to individual music tastes
- VIP seat function to optimise the sound for individual seats
- 5 sound profiles: "Pure", "Live", "Easy Listening", "Surround", "3D sound"
- Active driving noise compensation
- Supports multichannel audio formats
- 2-way in-car communication

# 3D Technology Package- Augmented Reality Head-Up Display + 3D Instrument Cluster (DF0) Standard



The latest projector technology projects a virtual image with relevant information into your field of vision. The display area is very much larger compared to a classic Head-Up Display. Colorful, superimposed content appears at a virtual distance of 32.8 feet ahead of the vehicle. This directly perceptible information blends seamlessly with reality. It provides real added value, especially in complex situations where you need to make a turn. When you arrive, your destination is marked prominently with the street name and house number.

Keep your eye on the important things in the 3D instrument cluster. The three-dimensional warnings and functions of the driving assistance systems are immediately noticeable with their striking 3D and shaded effects. Another trailblazing effect is the fascinating 3D image of cars, trucks, buses or motorcycles ahead of your vehicle.



# Models



## ***S580Z4 (223.976)***

- MSRP: \$184,900
- Transmission: 9G-TRONIC 9-Speed Automatic Transmission
- Acceleration 0-60pmg (sec): TBD
- Engine Configuration: 4.0L V8 Biturbo engine with EQ-Boost
- ICE Power (hp): 496 hp
- Torque (lb-ft): 516 lb-ft
- Launch Date: Second Half of 2021



## ***S680Z4 (223.979)***

- MSRP: TBD
- Transmission: 9G-TRONIC 9-Speed Automatic Transmission
- Acceleration 0-60pmg (sec): 4.5
- Engine Configuration: 6.0L V12 Biturbo
- ICE Power (hp): 621 hp
- Torque (lb-ft): 738 lb-ft
- Launch Date: First Half of 2022



# Standard Equipment

S580Z4



## *Performance & Handling*

- 9G-TRONIC 9-speed Automatic Transmission
- DYNAMIC SELECT
- 4.5 or 10 Degree Rear Axle Steering
- AIRMATIC Air Suspension
- ECO Start/Stop System

## *Comfort & Convenience*

- Powered, Rapid-Heated, and Ventilated Front and Rear Seats with Massaging Feature, 4-Position Memory, and Lumbar Support
- Power Rear-Window Sunshade and Powered Side Rear Sunshades
- 12.3" 3D Digital Instrument Cluster
- Garage Door Opener
- 12.8" OLED Touchscreen Center Display
- Fingerprint Sensor
- Active Ambient Lighting with Illuminated Door Sill Panels
- Power-Folding Mirrors
- KEYLESS-GO with Seamless Door Handles
- 4-Zone Automatic Climate Control
- Soft Close Doors
- "Hey Mercedes" Voice Control
- Heat Insulating, Noise Insulating, and Infrared-Reflecting Laminated Glass
- Active Parking Assist
- Double Front Sunvisors
- Adaptive Rear Lighting
- MBUX Augmented Reality Head-Up Display
- MBUX High-End Rear Seat Entertainment
- MBUX Interior Assistant Front and Rear
- MBUX with Navigation and "Hey Mercedes" Voice Control
- Panorama Roof
- Augmented Video for Navigation
- Wireless Charging Front and Rear
- Wireless Smartphone Integration (Apple Carplay, Android Auto™)
- KEYLESS Start
- Front Maybach LED Logo Projectors
- 8 USB-C Ports (4 Front, 4 Rear)
- Burmester® 4D Surround Sound System with Sound Personalization
- Exclusive Maybach Leather Upholstery
- Electronic Trunk Closer
- SiriusXM Radio with Free Trial Period
- Air Balance Package
- Toll Gate Transponder
- Online Music Streaming
- Automatic Seat Belt Extenders
- MBUX Rear Tablet
- Active Multicontour Rear Seats

## *Safety & Security*

- DIGITAL LIGHT LED Intelligent Light System
- Mercedes-Benz eCall Emergency System
- Antitheft Alarm System
- Surround View Camera
- Driver Assistance Package
- Auto-Dimming Mirrors
- MAGIC VISION CONTROL
- PRE-SAFE Impulse Side
- Dash Camera
- Rear Passenger Airbag and Rear Beltbags



## *Performance & Handling*

- 9G-TRONIC 9-speed Automatic Transmission
- DYNAMIC SELECT
- 4.5 or 10 Degree Rear Axle Steering
- AIRMATIC Air Suspension
- ECO Start/Stop System

## *Comfort & Convenience*

- Powered, Rapid-Heated, and Ventilated Front and Rear Seats with Massaging Feature, 4-Position Memory, and Lumbar Support
- Power Rear-Window Sunshade and Powered Side Rear Sunshades
- 12.3" 3D Digital Instrument Cluster
- Garage Door Opener
- 12.8" OLED Touchscreen Center Display
- Fingerprint Sensor
- Active Ambient Lighting with Illuminated Door Sill Panels
- Power-Folding Mirrors
- KEYLESS-GO with Seamless Door Handles
- 4-Zone Automatic Climate Control
- Soft Close Doors
- "Hey Mercedes" Voice Control
- Heat Insulating, Noise Insulating, and Infrared-Reflecting Laminated Glass
- Active Parking Assist
- Double Front Sunvisors
- Adaptive Rear Lighting
- MBUX Augmented Reality Head-Up Display
- MBUX High-End Rear Seat Entertainment
- MBUX Interior Assistant Front and Rear
- MBUX with Navigation and "Hey Mercedes" Voice Control
- Panorama Roof
- Augmented Video for Navigation
- Wireless Charging Front and Rear
- Wireless Smartphone Integration (Apple Carplay, Android Auto™)
- KEYLESS Start
- Front Maybach LED Logo Projectors
- 8 USB-C Ports (4 Front, 4 Rear)
- Burmester® 4D Surround Sound System with Sound Personalization
- Exclusive Maybach Leather Upholstery
- Electronic Trunk Closer
- SiriusXM Radio with Free Trial Period
- Air Balance Package
- Toll Gate Transponder
- Online Music Streaming
- Automatic Seat Belt Extenders
- MBUX Rear Tablet
- Active Multicontour Rear Seats

## *Safety & Security*

- DIGITAL LIGHT LED Intelligent Light System
- Mercedes-Benz eCall Emergency System
- Antitheft Alarm System
- Surround View Camera
- Driver Assistance Package
- Auto-Dimming Mirrors
- MAGIC VISION CONTROL
- PRE-SAFE Impulse Side
- Dash Camera
- Rear Passenger Airbag and Rear Beltbags





# Paint

## Non-Metallic Paints

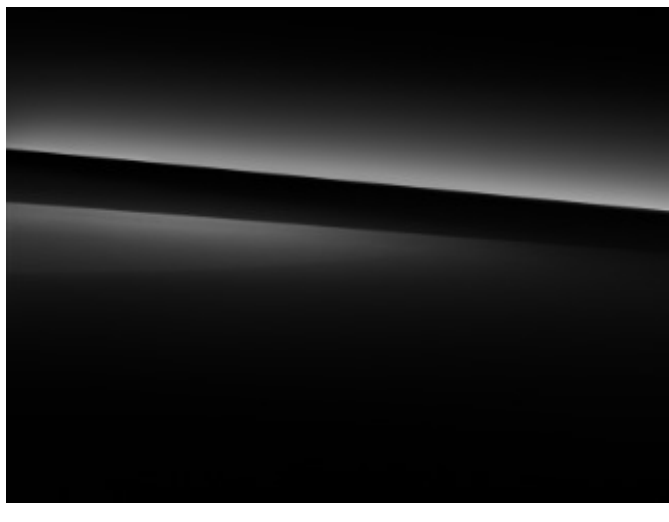

**040 - Black**  
Click to Enlarge

## Metallic Paints

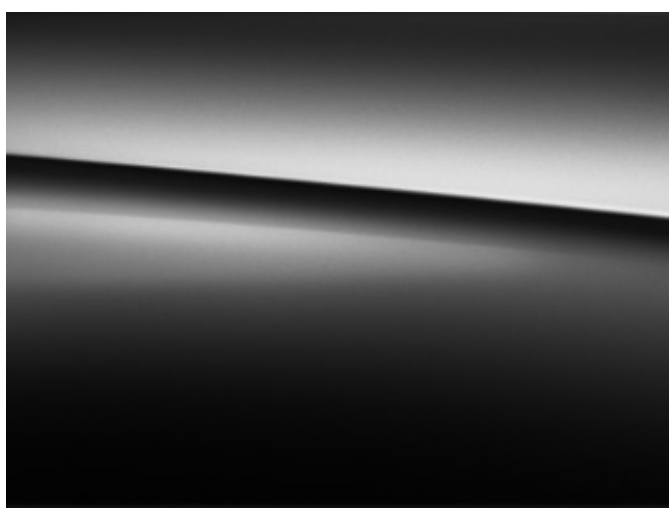

**197 - Obsidian Black**  
Click to Enlarge

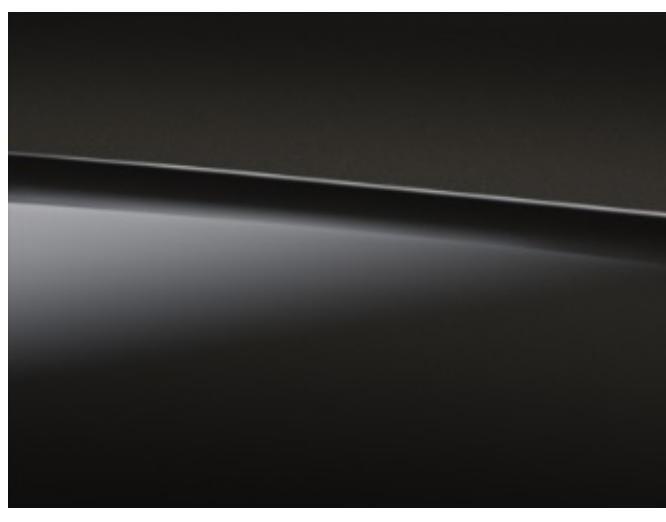

**346 - Onyx Black\***  
Click to Enlarge \*appears Metallic Brown in bright light



**595 - Nautical Blue**

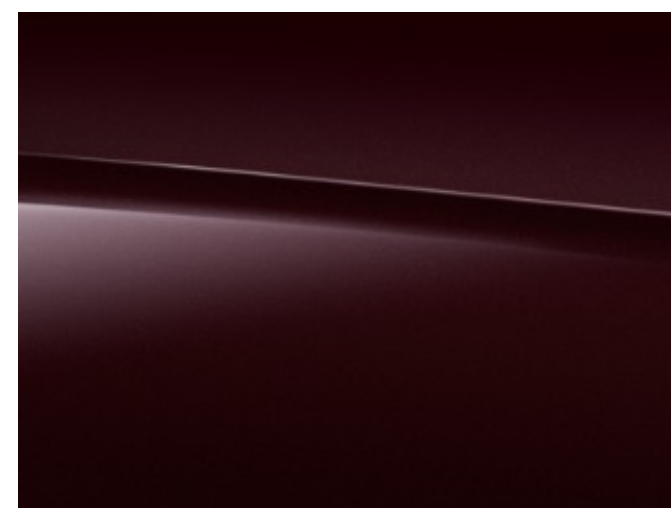

**660 - Rubellite Red**  
Click to Enlarge

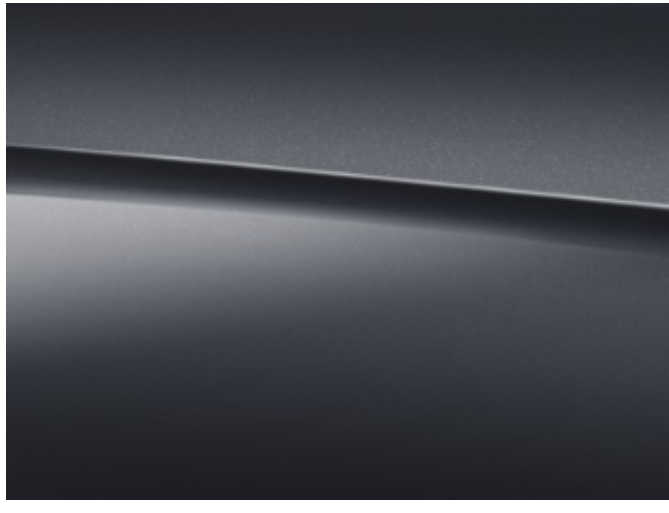

**831 - Graphite Grey**  
Click to Enlarge

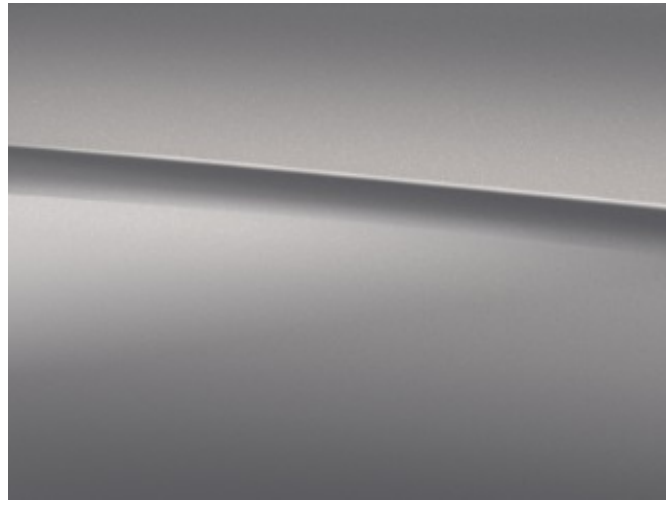

**859 - Mojave Silver**  
Click to Enlarge

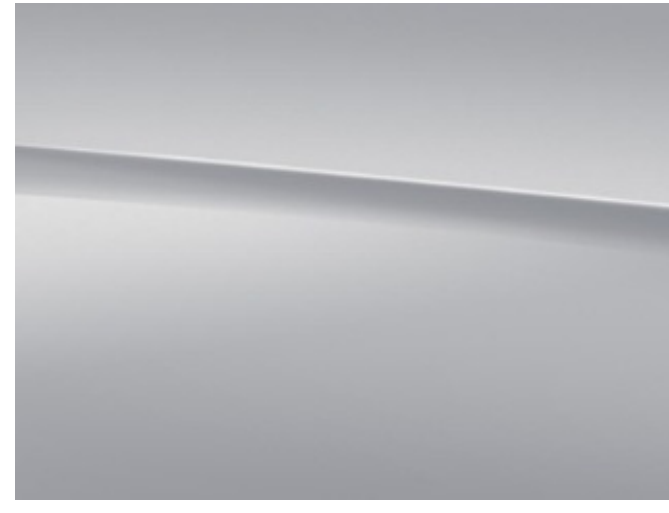

**922 - Cirrus Silver**  
Click to Enlarge

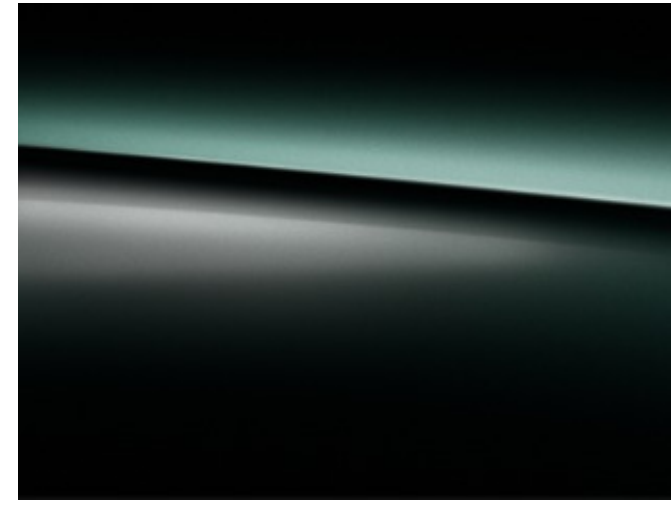

**989 - Emerald Green**  
Click to Enlarge

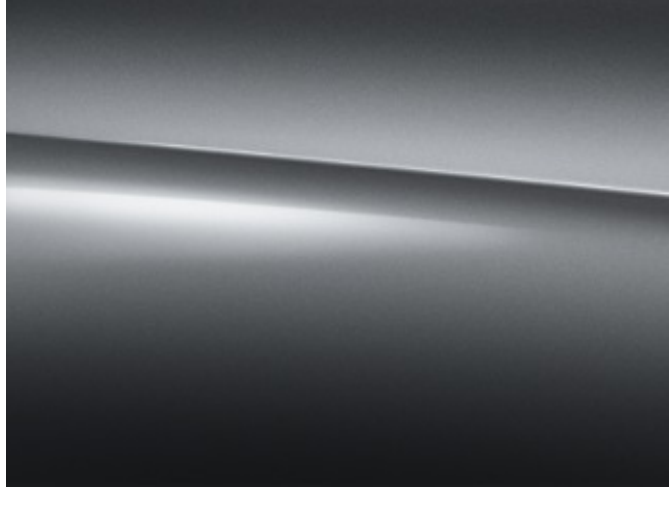

**992 - Selenite Grey**  
Click to Enlarge

## Exterior Two Tone Paint Combinations

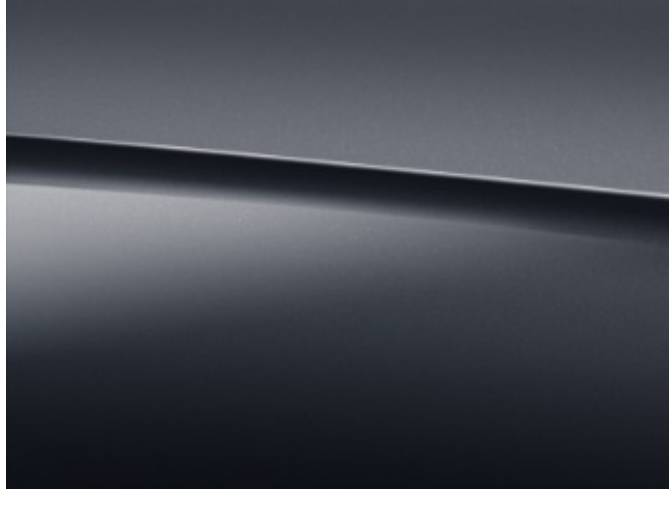

**C12 - Selenite Grey Upper / Obsidian Black Lower**

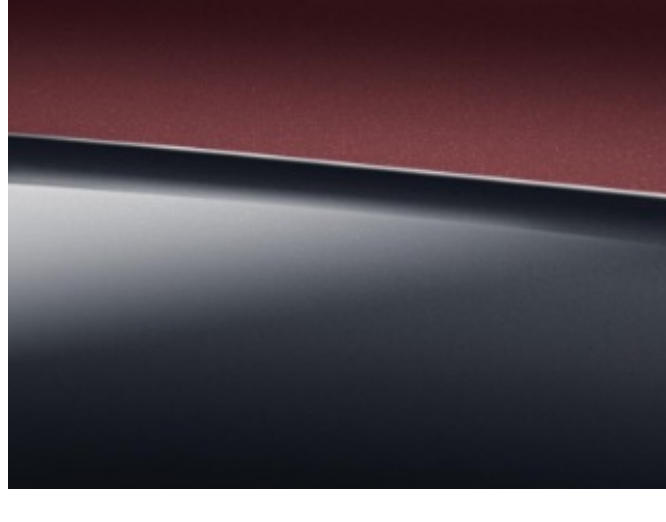

**C21 - Rubellite Red Upper / Obsidian Black Lower**



**C22 - Obsidian Black Upper / designo Diamond White Lower**



**C24 - Mojave Silver Upper / Emerald Green Lower**

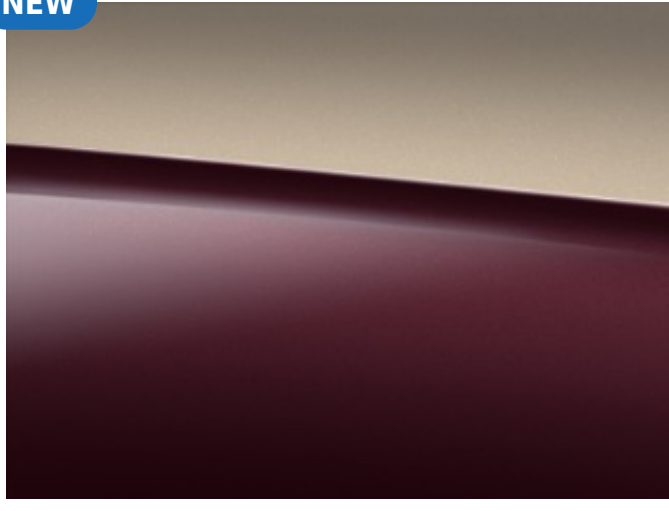

**C27 - Kalahari Gold Upper / Rubellite Red Lower**



**C28 - Cirrus Silver Upper / Nautical Blue Lower**



**C29 - Onyx Black Upper / Mojave Silver Lower**

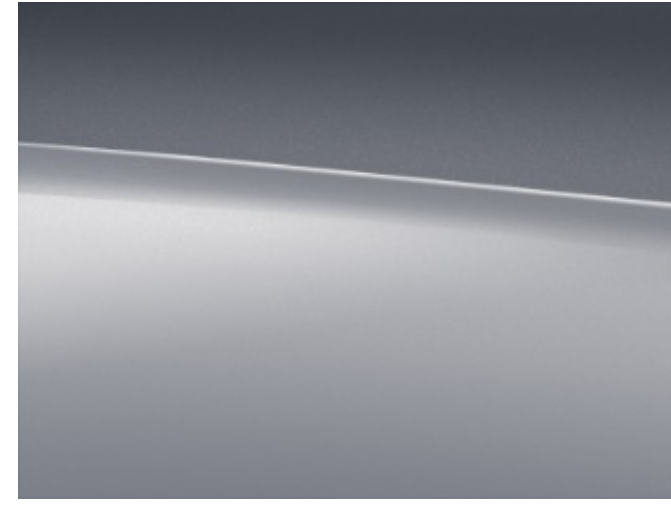

**C31 - Selenite Grey Upper / Cirrus Silver Lower**



**C32 - Kalahari Gold Upper / Onyx Black Lower**

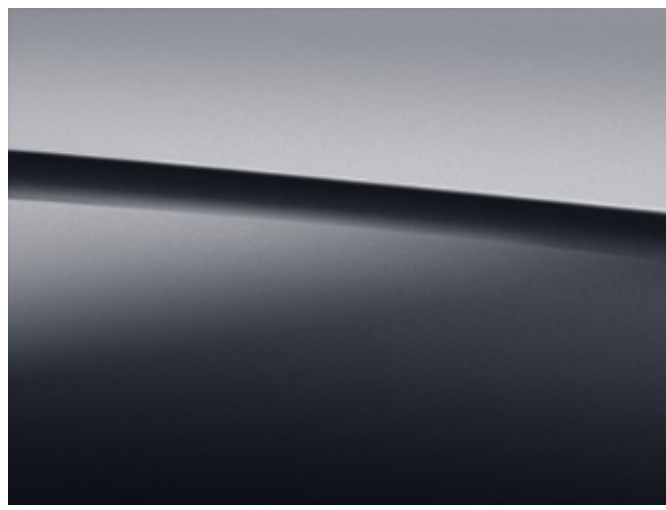

**C33 - Cirrus Silver Upper / Obsidian Black Lower**

## MANUFAKTUR Paints



**049 - MANUFAKTUR Cashmere White Magno**

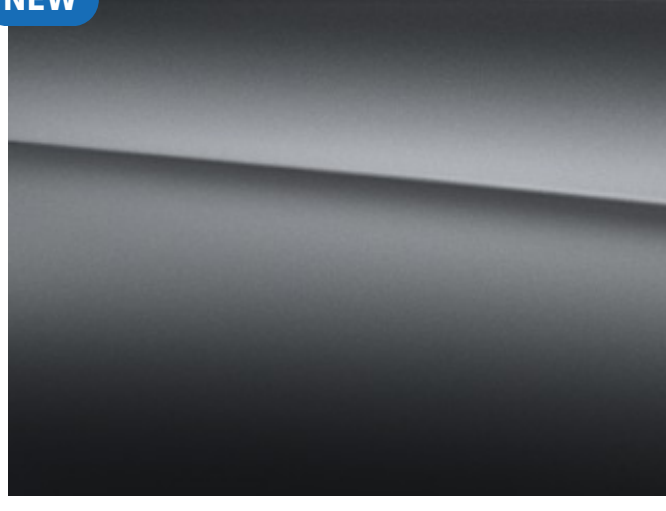

**297 - MANUFAKTUR Selenite Grey Magno**



**799 - MANUFAKTUR Diamond White**  
Click to Enlarge



**993 - MANUFAKTUR Patagonia Red**  
Click to Enlarge



**802 - MANUFAKTUR Kalahari Gold**

Code	Description	Availability	Price
040	Black Click to Enlarge	All Models	\$0
197	Obsidian Black Click to Enlarge	All Models	\$0
346	Onyx Black* Click to Enlarge *appears Metallic Brown in bright light	All Models	\$0
595 (New)	Nautical Blue	All Models	\$0
660	Rubellite Red Click to Enlarge	All Models	\$0
831	Graphite Grey Click to Enlarge	All Models	\$0
859	Mojave Silver Click to Enlarge	All Models	\$0
922	Cirrus Silver Click to Enlarge	All Models	\$0
989	Emerald Green Click to Enlarge	All Models	\$0
992	Selenite Grey Click to Enlarge	All Models	\$0
C12	Selenite Grey Upper / Obsidian Black Lower	All Models	\$14,500
C21	Rubellite Red Upper / Obsidian Black Lower	All Models	\$14,500
C22	Obsidian Black Upper / designo Diamond White Lower	All Models	\$14,500
C24	Mojave Silver Upper / Emerald Green Lower	All Models	\$14,500
C27 (New)	Kalahari Gold Upper / Rubellite Red Lower	All Models	\$14,500
C28 (New)	Cirrus Silver Upper / Nautical Blue Lower	All Models	\$14,500
C29 (Limited Availability)	Onyx Black Upper / Mojave Silver Lower	All Models	\$14,500
C31	Selenite Grey Upper / Cirrus Silver Lower	All Models	\$14,500
C32 (New)	Kalahari Gold Upper / Onyx Black Lower	All Models	\$14,500
C33	Cirrus Silver Upper / Obsidian Black Lower	All Models	\$14,500
049 (New)	MANUFAKTUR Cashmere White Magno	All Models	\$3,250
297 (New)	MANUFAKTUR Selenite Grey Magno	All Models	\$3,250
799	MANUFAKTUR Diamond White Click to Enlarge	All Models	\$1,750
993	MANUFAKTUR Patagonia Red Click to Enlarge	All Models	\$1,750
802 (New)	MANUFAKTUR Kalahari Gold	All Models	\$1,750



# Wheels



**R39 - 19" Maybach Exclusive 5-Spoke Wheel**

Click to Enlarge/ Non-Staggered  
19"

R02 (All-Season Tires)  
255/45 R19 on 8.5 J x 19 H2 ET31.5



**R61 - 20" Maybach Exclusive Forged Wheels**

Click to Enlarge/ Non-Staggered  
20"

R02 (All-Season Tires)  
255/40 R 20 tires on 9.0J x 20 H2 ET34



**53R - 20" Maybach Exclusive Forged Wheels**

Click to Enlarge/ Staggered  
20"

R02 (All-Season Tires)  
255/40 R 20 tires on 9.0J x 20 H2 ET34 (Front) / 285/35 R 20 tyres on 10.0J x 20 H2 ET48.1 (Rear)

LIMITED AVAILABILITY



**70R - 21" Maybach Exclusive Multi-Spoke Champagne Flute Wheel**

Click to Enlarge/ Non-Staggered  
21"

R01 (High-Performance Tires)  
265/35 R21 on 9.0 J x 21 H2 ET34 101XL

<i>Code</i>	<i>Wheel Size</i>	<i>Description</i>	<i>Wheel Dimensions</i>	<i>Mobility</i>	<i>Availability</i>	<i>MSRP</i>
R39	19"	Click to Enlarge/ Non-Staggered	255/45 R19 on 8.5 J x 19 H2 ET31.5	R02 (All-Season Tires)	All Models	\$0
R61	20"	Click to Enlarge/ Non-Staggered	255/40 R 20 tires on 9.0J x 20 H2 ET34	R02 (All-Season Tires)	All Models	\$0
53R	20"	Click to Enlarge/ Staggered	255/40 R 20 tires on 9.0J x 20 H2 ET34 (Front) / 285/35 R 20 tyres on 10.0J x 20 H2 ET48.1 (Rear)	R02 (All-Season Tires)	All Models	\$0
70R (Limited Availability)	21"	Click to Enlarge/ Non-Staggered	265/35 R21 on 9.0 J x 21 H2 ET34 101XL	R01 (High-Performance Tires)	All Models	\$1,300



# Upholstery

## Exclusive Nappa Leather

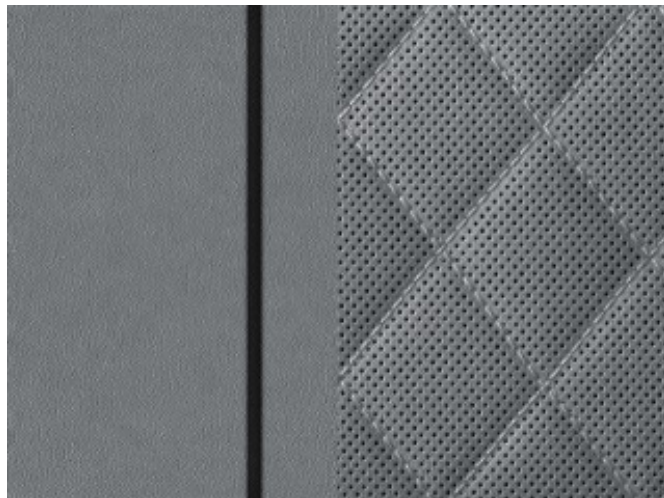
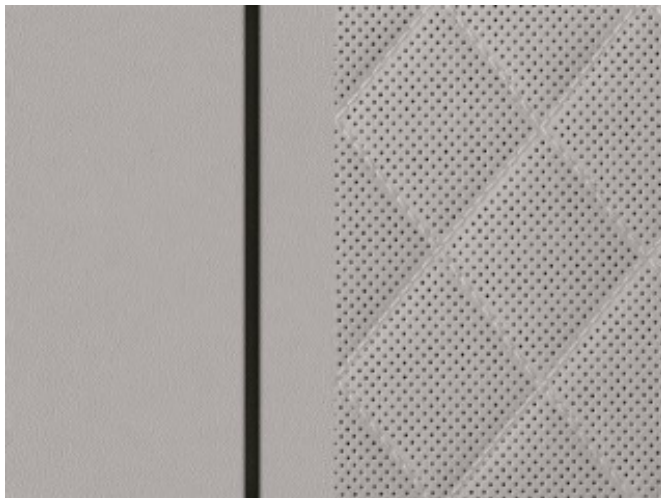
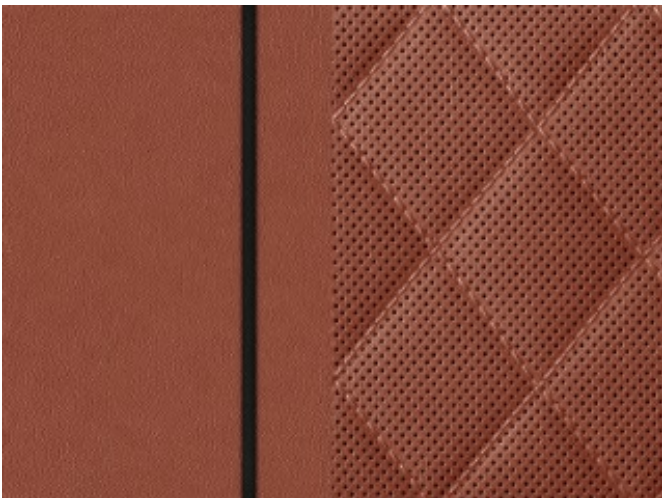
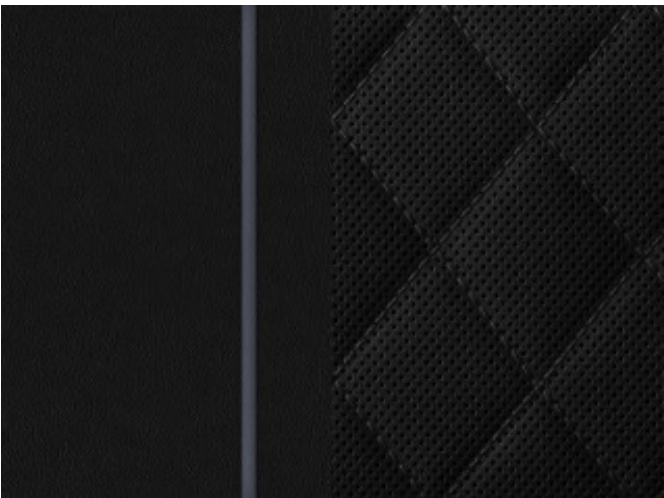

**511 - Exclusive Maybach Leather Black**

Click to Enlarge/ Requires 71U (designo Roof Liner in Black Nappa Leather) or 78U (designo Roof Liner in Neva Grey Nappa Leather)

**514 - Exclusive Maybach Leather Sienna Brown & Black**

Click to Enlarge/ Requires 71U (designo Roof Liner in Black Nappa Leather) Not Available with C32 (Kalahari Gold Upper / Onyx Black Lower)

**515 - Exclusive Maybach Leather Macchiato & Bronze Brown Pearl**

Click to Enlarge/ Requires 75U (designo Roof Liner in Porcelain Nappa Leather)

**518 - Exclusive Maybach Leather Silver Grey & Black**

Click to Enlarge/ Requires Requires 71U (designo Roof Liner in Black Nappa Leather) or 78U (designo Roof Liner in Neva Grey Nappa Leather)

**NEW LIMITED AVAILABILITY**

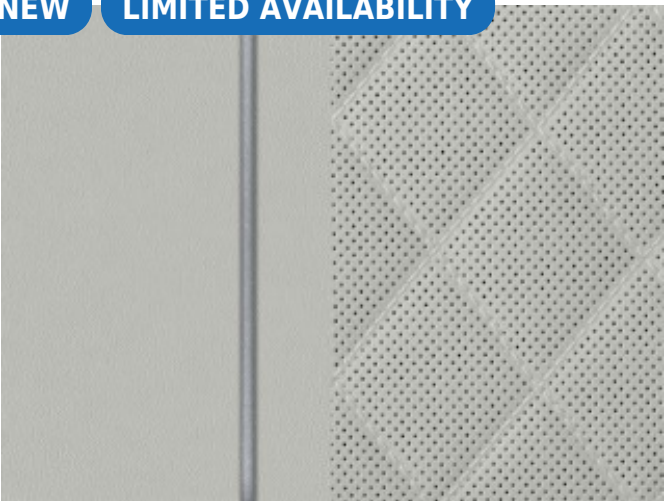

**519 - MANUFAKTUR Crystal White & Silver Grey Pearl**

Requires 79U (designo Rook Liner in Crystal White) Requires H17-Piano Lacquer Flowing Lines/Requires U61-MANUFAKTUR Leather Package/ Requires DB6-Executive Rear Seat Package Plus/ Not Available with C24 (Mojave Silver Upper / Emerald Green Lower)/Not Available with C27 (Kalahari Gold Upper / Rubellite Red Lower)



<i>Code</i>	<i>Description</i>	<i>Availability</i>	<i>Price</i>
511	Exclusive Maybach Leather Black Click to Enlarge/ Requires 71U (designo Roof Liner in Black Nappa Leather) or 78U (designo Roof Liner in Neva Grey Nappa Leather)	All Models	\$0
514	Exclusive Maybach Leather Sienna Brown & Black Click to Enlarge/ Requires 71U (designo Roof Liner in Black Nappa Leather) Not Available with C32 (Kalahari Gold Upper / Onyx Black Lower)	All Models	\$0
515	Exclusive Maybach Leather Macchiato & Bronze Brown Pearl Click to Enlarge/ Requires 75U (designo Roof Liner in Porcelain Nappa Leather)	All Models	\$0
518	Exclusive Maybach Leather Silver Grey & Black Click to Enlarge/ Requires Requires 71U (designo Roof Liner in Black Nappa Leather) or 78U (designo Roof Liner in Neva Grey Nappa Leather)	All Models	\$0
519 (New) ted Availability)	MANUFAKTUR Crystal White & Silver Grey Pearl Requires 79U (designo Rook Liner in Crystal White) Requires H17-Piano Lacquer Flowing Lines/Requires U61-MANUFAKTUR Leather Package/ Requires DB6-Executive Rear Seat Package Plus/ Not Available with C24 (Mojave Silver Upper / Emerald Green Lower)/Not Available with C27 (Kalahari Gold Upper / Rubellite Red Lower)	All Models	\$13,500

<i>Code</i>	<i>Upholstery</i>	<i>Seats</i>	<i>Floor Mats</i>	<i>Upper Dash/Lower Dash</i>	<i>Seat Belts</i>	<i>Steering Wheel</i>	<i>Headliner</i>
511	Exclusive Maybach Leather Black Click to Enlarge/ Requires 71U (designo Roof Liner in Black Nappa Leather) or 78U (designo Roof Liner in Neva Grey Nappa Leather)	Black	Black	Black	Black	Black	Black or Grey
514	Exclusive Maybach Leather Sienna Brown & Black Click to Enlarge/ Requires 71U (designo Roof Liner in Black Nappa Leather) Not Available with C32 (Kalahari Gold Upper / Onyx Black Lower)	Sienna Brown	Black	Black	Black	Black	Black
515	Exclusive Maybach Leather Macchiato & Bronze Brown Pearl Click to Enlarge/ Requires 75U (designo Roof Liner in Porcelain Nappa Leather)	Macchiato	Macchiato	Bronze Brown Pearl	Macchiato	Beige	Porcelain
518	Exclusive Maybach Leather Silver Grey & Black Click to Enlarge/ Requires Requires 71U (designo Roof Liner in Black Nappa Leather) or 78U (designo Roof Liner in Neva Grey Nappa Leather)	Silver Grey	Black	Silver Grey	Black	Black	Black or Silver Grey
519 (New) (Limited Availability)	MANUFAKTUR Crystal White & Silver Grey Pearl Requires 79U (designo Rook Liner in Crystal White) Requires H17-Piano Lacquer Flowing Lines/Requires U61-MANUFAKTUR Leather Package/ Requires DB6-Executive Rear Seat Package Plus/ Not Available with C24 (Mojave Silver Upper / Emerald Green Lower)/Not Available with C27 (Kalahari Gold Upper / Rubellite Red Lower)	White	Black	Silver Grey Pearl	Black	Black	White



# Trims



**H02 - Fineline “Anthracite” Natural Grain**

[Click to Enlarge](#)

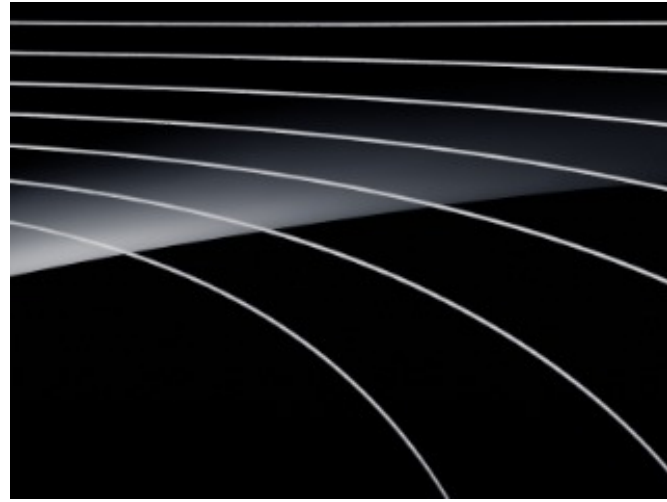

**H17 - Piano Lacquer Flowing Lines**

[Click to Enlarge](#)

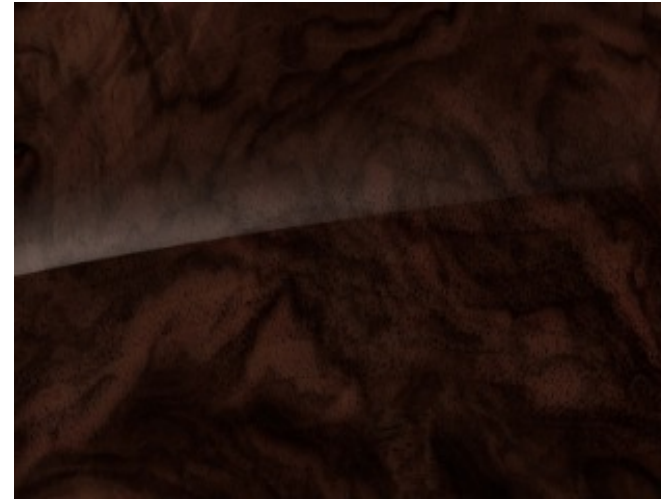

**H29 - Brown High-Gloss Burl Walnut Wood**

[Click to Enlarge](#)



**H37 - Slate High-Gloss Poplar Wood**

[Click to Enlarge](#)



**H75 - Stainless Steel-Metal Blended Black/Silver**

[Click to Enlarge](#)

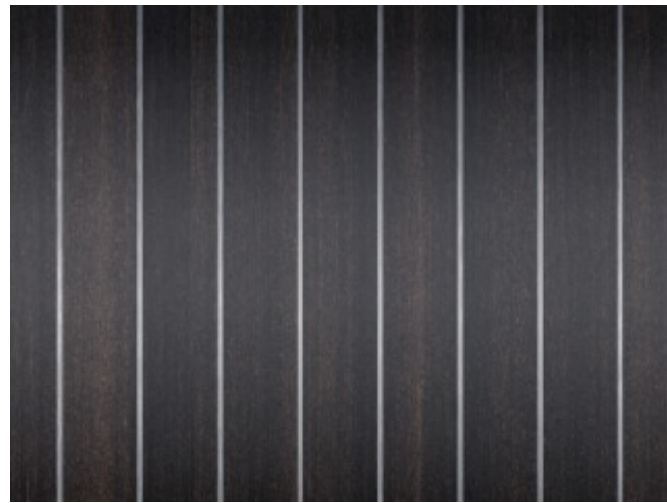

**H38 - Silver Aluminum Fanned Walnut Wood**

[Click to Enlarge](#)

<i>Code</i>	<i>Description</i>	<i>Availability</i>	<i>Price</i>
H02	Fineline “Anthracite” Natural Grain <a href="#">Click to Enlarge</a>	All Models	\$0
H17	Piano Lacquer Flowing Lines <a href="#">Click to Enlarge</a>	All Models	\$1,300
H29	Brown High-Gloss Burl Walnut Wood <a href="#">Click to Enlarge</a>	All Models	\$0
H37	Slate High-Gloss Poplar Wood <a href="#">Click to Enlarge</a>	All Models	\$0
H75	Stainless Steel-Metal Blended Black/Silver <a href="#">Click to Enlarge</a>	All Models	TBD (S580Z4) \$850 (S680Z4)
H38	Silver Aluminum Fanned Walnut Wood <a href="#">Click to Enlarge</a>	All Models	\$3,200



# Packages

<i>Code</i>	<i>Packages</i>	<i>Availability</i>	<i>MSRP</i>
DB6	Executive Rear Seat Package Plus <ul style="list-style-type: none"><li>▪ 224 - First Class 4-Seat Configuration</li><li>▪ 449 - Folding Rear Tables</li></ul>	All Models	\$6,000



# Options

## Factory Options

<i>Code</i>	<i>Options</i>	<i>Availability</i>	<i>MSRP</i>
308	Rear Fridge with Maybach Champagne Flutes Only with Executive Rear Seat Package Plus DB6	All Models	\$4,300
68B	Electric Comfort Doors in Rear	All Models	\$1,350
490 (New)	E- Active Body Control	S580Z4	TBD
U61	designo Leather Package	All Models	\$8,000



## VPC Installed Options

<i>Code</i>	<i>Options</i>	<i>Availability</i>	<i>MSRP</i>
D07	Wheel Locking Bolts		\$150
D10	Rear Deck Spoiler in Body Color	All Models	\$500
D21	Rear Spoiler - Black	All Models	\$500
D28	Comfort Box	All Models	\$350
D43	All-Season Front & Rear Floor Mats, Black Rubber	All Models	\$160
D49	First Aid Kit		\$35





# Specifications

S580Z4



## Chassis

## Drivetrain

**Transmission** 9G-TRONIC 9-Speed Automatic Transmission

**Drive Configuration** All-wheel Drive

## Engine

**Engine Configuration** 4.0L V8 Biturbo engine with EQ-Boost

**ICE Power (hp)** 496 hp

**Torque (lb-ft)** 516 lb-ft

**Compression Ratio** TBD

**Fuel Requirement (Octane)** TBD

**Fuel Tank Size (gallons)** 22.19

**Displacement (cc)** 3982

## Performance

**Acceleration 0-60pmg (sec)** TBD

**Top Speed (mph)** 130

**Transmission Speeds** 9

**Towing Capacity (lbs)** TBD

**Maximum Load** TBD

## Fuel Economy

**City Fuel Economy** TBD

**Highway Fuel Economy** TBD

**Emission Certification** TBD

## Exterior Dimensions

**Vehicle Length (in.)** 215.3

**Vehicle Height (in.)** 59.4

**Vehicle Width w/ exterior mirrors (in.)** 83.0

**Wheelbase (in.)** 133.7

**Curb Weight (lbs)** TBD

**Track Width Front/Rear (in.)** TBD

## Interior Dimensions

**Trunk Size (cubic feet)** 12.9

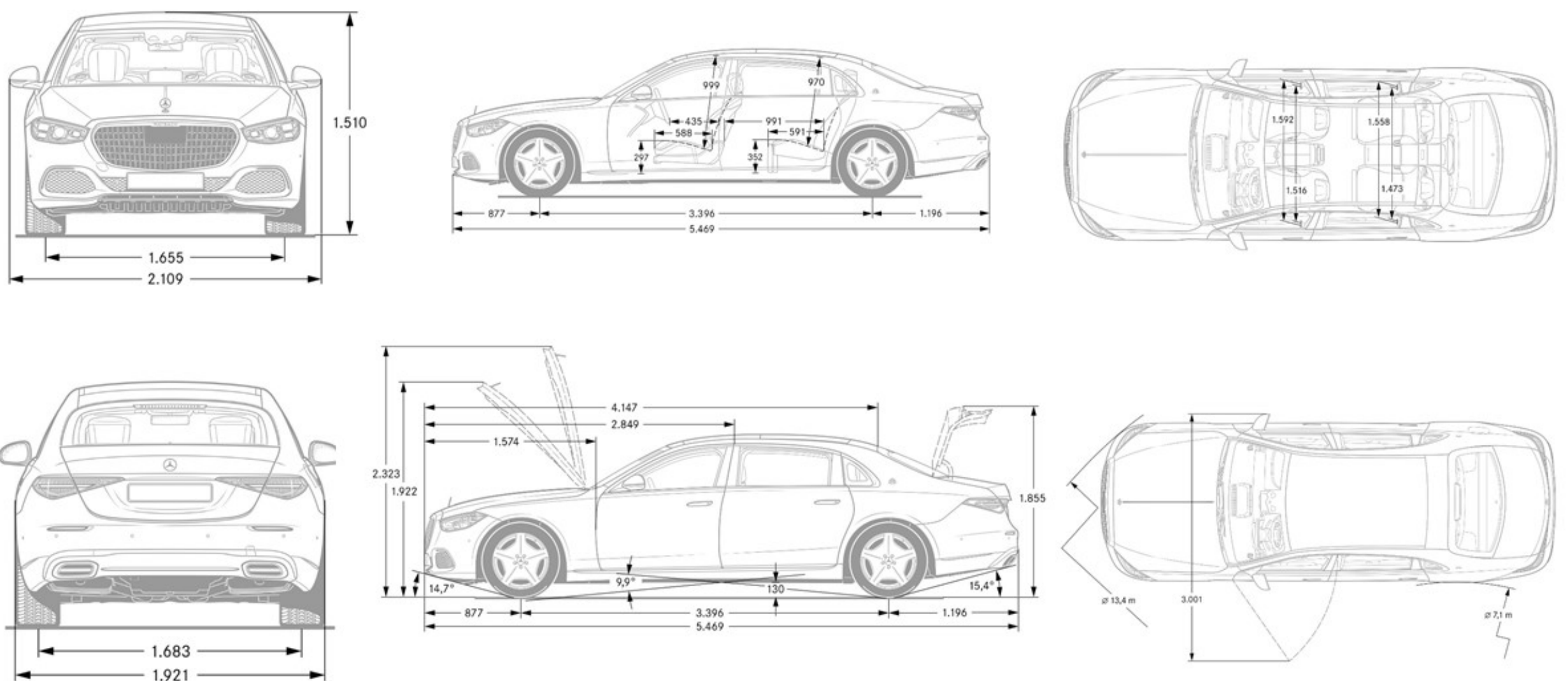

*Drivetrain*

<b>Transmission</b>	9G-TRONIC 9-Speed Automatic Transmission
<b>Drive Configuration</b>	All-wheel Drive

*Engine*

<b>Engine Configuration</b>	6.0L V12 Biturbo
<b>ICE Power (hp)</b>	621 hp
<b>Torque (lb-ft)</b>	738 lb-ft
<b>Compression Ratio</b>	TBD
<b>Fuel Requirement (Octane)</b>	TBD
<b>Fuel Tank Size (gallons)</b>	22.19
<b>Displacement (cc)</b>	5980

*Performance*

<b>Acceleration 0-60pmg (sec)</b>	4.5
<b>Top Speed (mph)</b>	130
<b>Transmission Speeds</b>	9
<b>Towing Capacity (lbs)</b>	TBD
<b>Maximum Load</b>	TBD

*Fuel Economy*

<b>City Fuel Economy</b>	TBD
<b>Highway Fuel Economy</b>	TBD
<b>Emission Certification</b>	TBD

*Exterior Dimensions*

<b>Vehicle Length (in.)</b>	215.3
<b>Vehicle Height (in.)</b>	59.4
<b>Vehicle Width w/ exterior mirrors (in.)</b>	83.0
<b>Wheelbase (in.)</b>	133.7
<b>Curb Weight (lbs)</b>	5346
<b>Track Width Front/Rear (in.)</b>	TBD

*Interior Dimensions*

<b>Trunk Size (cubic feet)</b>	12.3
--------------------------------	------

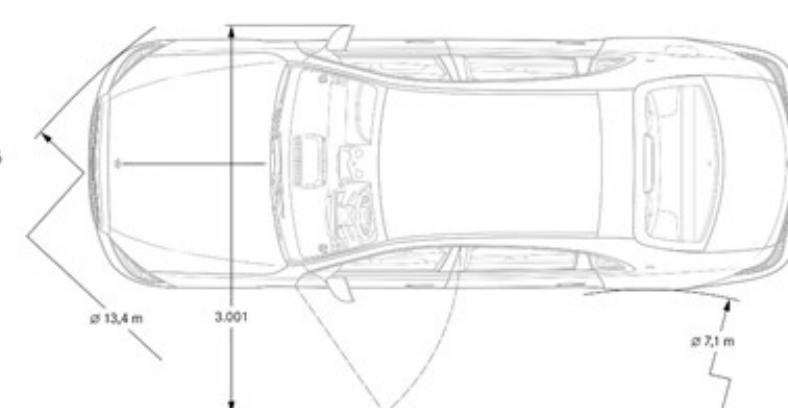
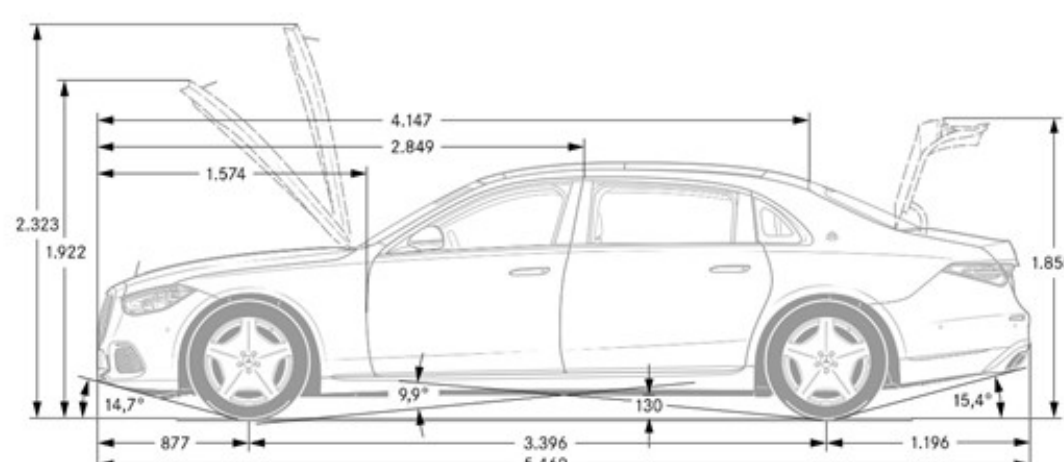
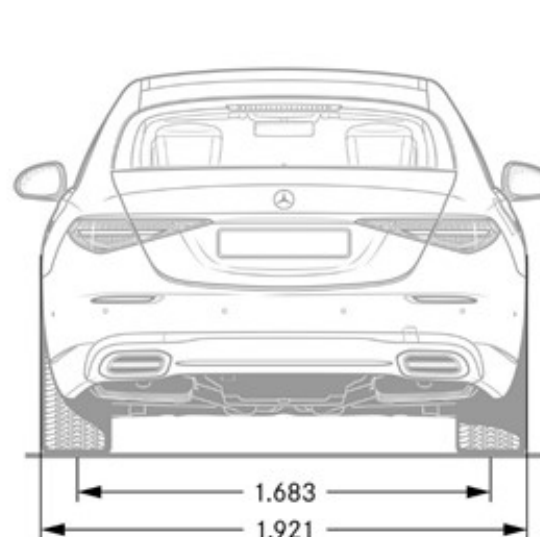
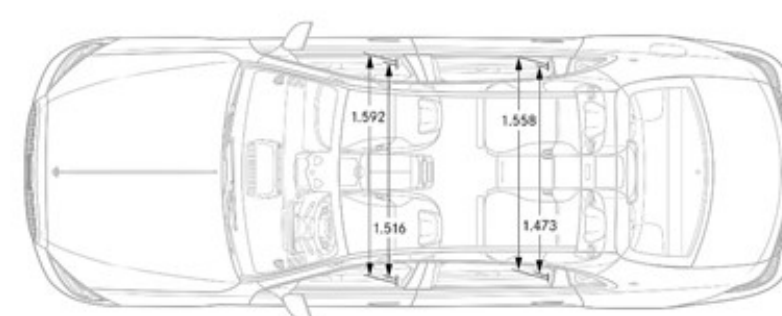
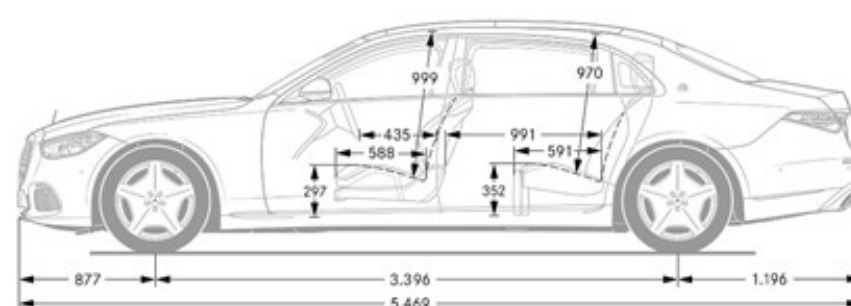
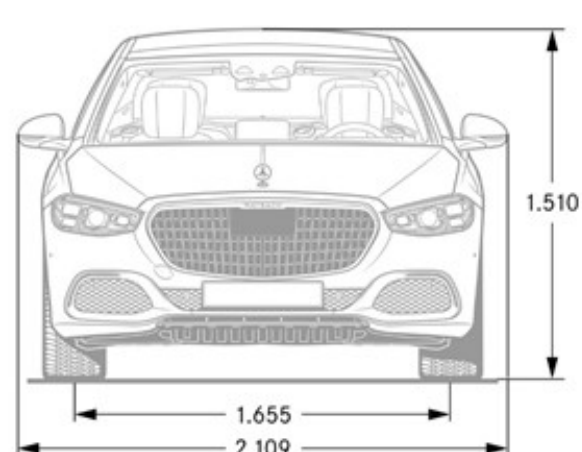

# Options In Detail

## Steering Wheel



### 3-spoke Nappa Leather Steering Wheel (L2B)

Standard

- 3-Spoke Steering Wheel
- "Maybach" lettering in the vertical spoke
- Spokes in high-gloss black with silver chrome surround
- Steering wheel paddle shifters in silver chrome
- Operation via Touch Control panels:
  - Left: e.g. instrument cluster, Active Distance Assist DISTRONIC
  - Right: multimedia system (e.g. audio volume and title selection, telephony and navigation)
  - Touch sensitivity adjustable via central display



### 3-spoke Wood & Leather Steering Wheel (L2D)

Standard

**Not with *Fineline Anthracite Natural Grain (H02)*, *Silver Aluminum Fanned Walnut (H38)***

- 3-Spoke Steering Wheel
- "Maybach" lettering in the vertical spoke
- Spokes in high-gloss black with silver chrome surround
- Steering wheel paddle shifters in silver chrome
- Operation via Touch Control panels:
  - Left: e.g. instrument cluster, Active Distance Assist DISTRONIC
  - Right: multimedia system (e.g. audio volume and title selection, telephony and navigation)
  - Touch sensitivity adjustable via central display





## Executive Rear Seat Package Plus-DB6 (Optional)

With the Executive Rear Seat Package Plus you travel as comfortably as you do in a private jet. The business centre console represents a huge gain for the rear passengers both visually and functionally. For example it pampers them with temperature-controlled cup holders and stowage compartments beneath an electrically opening cover. You can charge your smartphone beneath the armrest inductively and thus wirelessly.

- Sweeping trim element flowing continuously behind the rear seats into the centre console, with exclusive Mercedes-Maybach logo as well as integrated stowage compartment
- Beneath the electrically operated cover in the front section of the business centre console:
  - Double temperature-controlled cup holder
  - Control elements for THERMOTRONIC automatic climate control in the rear
  - Additional stowage compartment
- Armrest with stowage area for MBUX Rear tablet
- Stowage compartment under the armrest with
  - Wireless charging for mobile phones in the rear
- Extensive integration into the ambient lighting such as with glove box lighting as well as function lighting in red/blue (warm/cold) for the cup holders
- Folding tables in the rear (449) which can be pulled out from the stowage compartment beneath the armrest
- HDMI connections beneath the armrest



## Electric Comfort Doors in Rear- 68B (Optional)

The comfort doors allow you to get in to the rear of your Mercedes-Maybach and alight once again with just as much comfort and convenience. The electric doors elegantly open and close again as and when you wish.

An electric actuator motor in each of the rear doors swings the doors open and shut as required in a controlled manner. If you park on a slope or an incline, the doors open and close with ease thanks to the drive system.

Operation of the comfort doors is versatile: using the vehicle key, by touching the door handles on the outside, via the central display or the MBUX High-End Rear Entertainment system. In addition, you can open the doors by pressing and holding the switch in the overhead control unit. A quick touch is all you need to close the door.

When getting in and out, your Mercedes-Maybach optimally watches out for your safety and the well-being of other road users. If the Blind Spot Assist is active, you should only open the doors if no barriers have been detected. As soon as the Blind Spot Assist detects other road users in the area of the door, you are notified by means of the exit warning function.

# MANUFAKTUR Leather Package

The MANUFAKTUR Leather Package takes the feel-good atmosphere and the flair of your Mercedes-Maybach interior to a new level. Luxury that you can feel, touch and even smell. The finest Nappa Leather surrounds you in the entire vehicle – from exclusive upholstery cushions for the Executive seats to the striking topstitching.

Components:

- 2 Upholstery Cushions Covered in Nappa Leather in Appointments Color, with Diamond Quilting and Mercedes-Maybach logo plus Piping in Contrasting Color
- Upper and Side Cover on the Instrument Panel Covered in Nappa Leather
- Sun Visors, Door Pockets on Driver's and Front-Passengers backrest, Window frame, A-, B- and C- Pillar covered in Nappa Leather
- Front Seat Console on Driver and Front Passenger Sides in Nappa Leather in the Appointments Color and with Topstitching
- Insert in the Door Sill Panels in Nappa look in the Appointments Color



# Gallery

