

# 2021 CLS Coupe Order Guide



# Table of Contents

1	<a href="#">General Information</a>
2	<a href="#">What's New</a>
3	<a href="#">Models</a>
4	<a href="#">Equipment</a>
4.1	<a href="#">Standard Equipment</a>
4.2	<a href="#">Exterior Paint Colors</a>
4.3	<a href="#">Wheels</a>
4.4	<a href="#">Interior Upholstery</a>
4.6	<a href="#">Interior Trims</a>
4.7	<a href="#">Packages</a>
4.8	<a href="#">Options</a>
4.9	<a href="#">Specifications</a>
5	<a href="#">Options In Detail</a>
6	<a href="#">Build Recommendations</a>
7	<a href="#">Gallery</a>

# General Information

## Important Note

The information presented in this guide is based on the most current information available and is intended for internal use only. Mercedes-Benz reserves the right to make changes at any time, without notice, to colors, materials, equipment, special specifications and models.

Pricing may not yet be finalized for some models or options.

Due to variances among monitors and printers the colors that appear on your screen and printouts may not be exact.

For illustrative purposes, some images may show vehicles with European Specification.

## Revision History

Date	Description
08/11/2020	Package and option pricing published for 450 models
08/03/2020	Misc. AMG pricing updates (L6G, RZU)
07/17/2020	AMG MSRP added
06/15/2020	Deep Green Non-Metallic (825) and Midnight Blue Non-Metallic (904) designo® Manufaktur paints are no longer delayed availability
06/03/2020	Initial draft published

# What's New

## CLS53C4



### *Paints*

- **Cirrus Silver**

### *Standard Equipment*

- **"Hey Mercedes" Voice Control**
- **12.3" Infotainment Screen w/ touch functionality**
- **MBUX Infotainment System and Navigation System**
- **Power Rear Window Sunshade**
- **Touchpad**
- **Surround-View Camera**

### *Options*

- **Dashcam**
- **Air Balance**
- **MBUX Interior Assistant**
- **Augmented Video**

### *Standard Equipment*

- **MBUX Infotainment System w/ Touchscreen**
- **Surround View Camera**
- **"Hey Mercedes" Voice Control**
- **Power Rear Sunshade**

### *Optional Equipment*

- **Mojave Silver (859)**
- **MBUX Augmented Reality (U19)**
- **Dashcam (21U)**
- **Cirrus Silver (922)**
- **Interior Assistant (77B)**

# Models



## ***CLS53C4 (257.361)***

- MSRP: \$81,550
- Transmission: AMG SPEEDSHIFT TCT 9G (9 speed)
- Acceleration 0-60 mph (sec): 4.3 (est.)
- Engine Configuration: AMG-enhanced 3.0L inline-6 turbo with EQ Boost & Electric Aux. Compressor
- Power (hp; Internal Combustion Engine only): 429 @ 6,100
- Torque (lb-ft; Internal Combustion Engine only): 384 @ 1,800 - 5,800
- Launch Date: TBA

# Standard Equipment

CLS53C4



## *Performance & Handling*

- AMG-enhanced 3.0L Inline-6 Turbo Engine with EQ-Boost and Electric Aux. Compressor (429 hp, 384 lb-ft torque)
- Electric Auxiliary Compressor
- AMG Sport Suspension based on AIR BODY CONTROL
- AMG DYNAMIC SELECT
- Steering Wheel Mounted Shift Paddles
- EQ Boost Starter-Alternator
- AMG SPEEDSHIFT TCT 9G Transmission (Torque Converter Transmission)
- 19" AMG Wheels
- Rear Spoiler

## *Comfort & Convenience*

- 12.3" Widescreen Instrument Cluster
- MBUX Infotainment System and Navigation System
- Touchpad
- Bluetooth® Connectivity
- Inductive Wireless Charging w/ NFC Pairing
- Smartphone Integration with Apple Carplay™ & Android Auto
- Power tilt/sliding sunroof
- Power Heated Front Seats w/ Memory & Lumbar Support
- Power Folding Mirrors
- KEYLESS-START
- Mercedes me connect
- Garage Door Opener
- Auto-Dimming Driver-Side and Rearview Mirrors
- AMG Illuminated Door Sills
- 12.3" Infotainment Screen w/ touch functionality
- "Hey Mercedes" Voice Control
- Burmester® Surround Sound System
- SiriusXM® Radio All-Access w/ Trial Period
- AMG Performance Steering Wheel w/ Touch Control Buttons
- LED Headlamps and Taillamps
- 64-Color Ambient Lighting
- Split folding rear seats (40/20/40)
- Power Rear Window Sunshade
- KEYLESS-GO w/ HANDS-FREE ACCESS
- Electronic Trunk Closer
- Heated Windshield Washer System
- Storage Package

## *Safety & Security*

- Active Brake Assist
- Blind Spot Assist
- eCall-emergency system
- PRE-SAFE®
- Anti-Theft Alarm System
- Active Parking Assist
- ATTENTION ASSIST®
- Car-to-X Communication
- Extended Mobility Tires
- PRE-SAFE Sound
- Surround-View Camera

# Paint

## Non-Metallic Paints

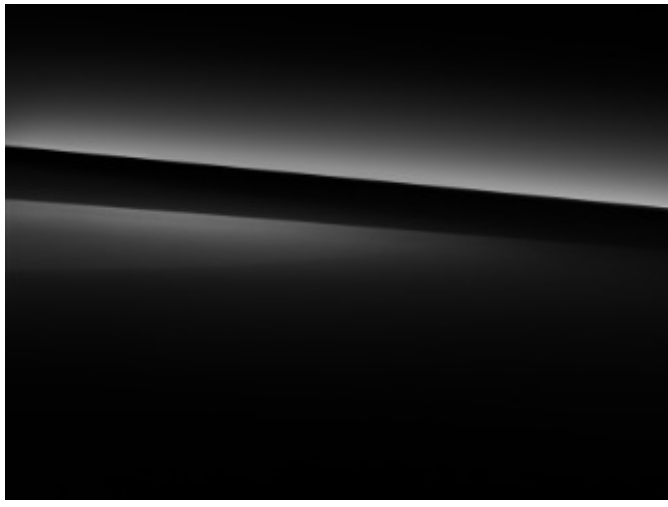

040 - Black

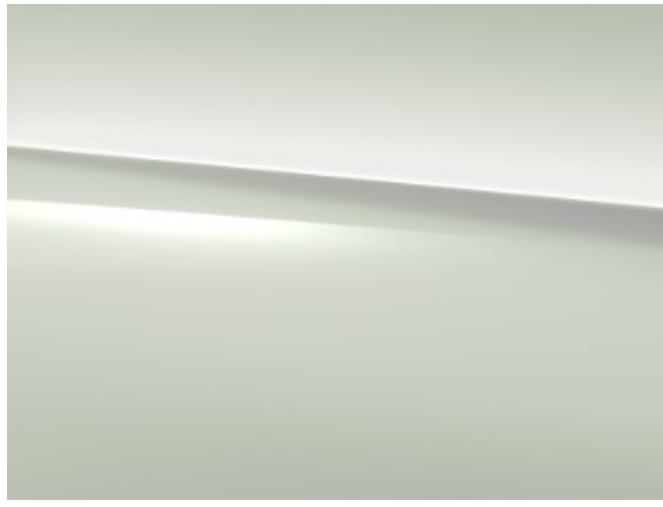

149 - Polar White

## Metallic Paints

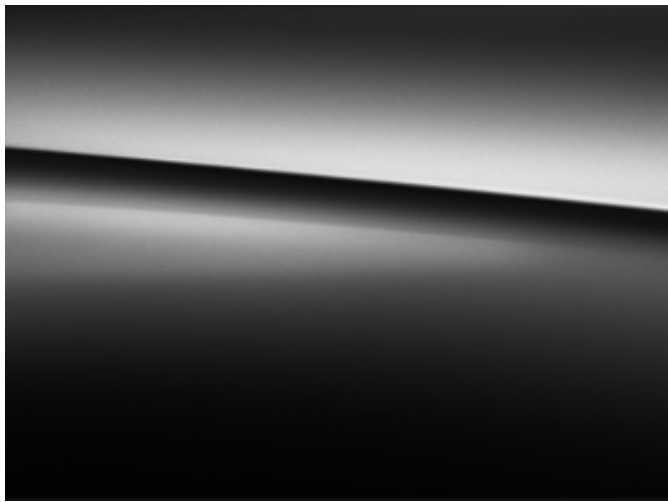

197 - Obsidian Black

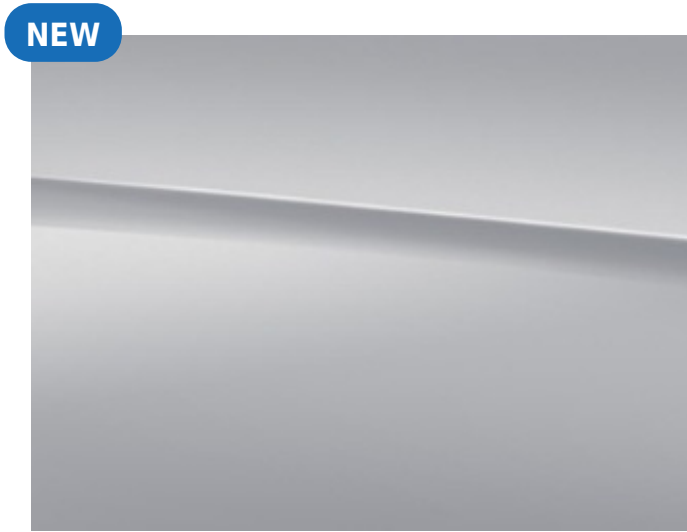

922 - Cirrus Silver

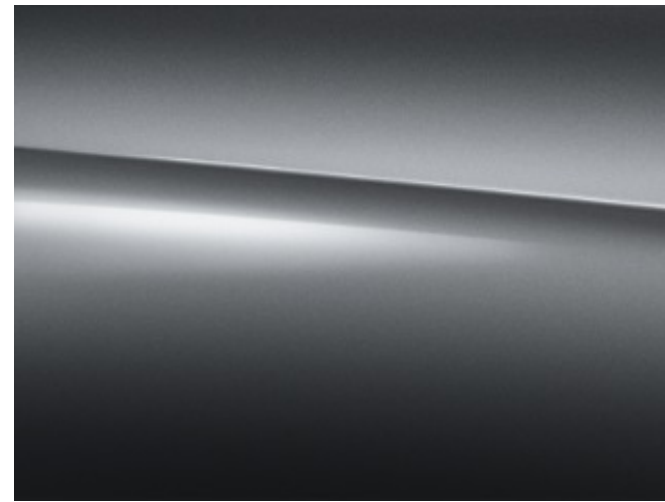

992 - Selenite Grey

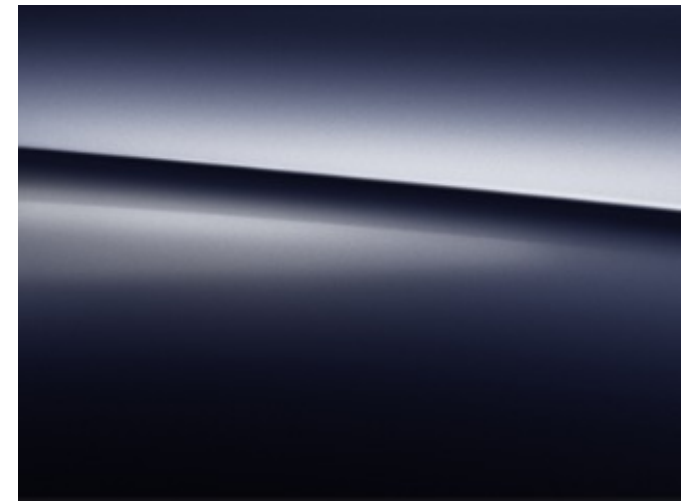

890 - Lunar Blue

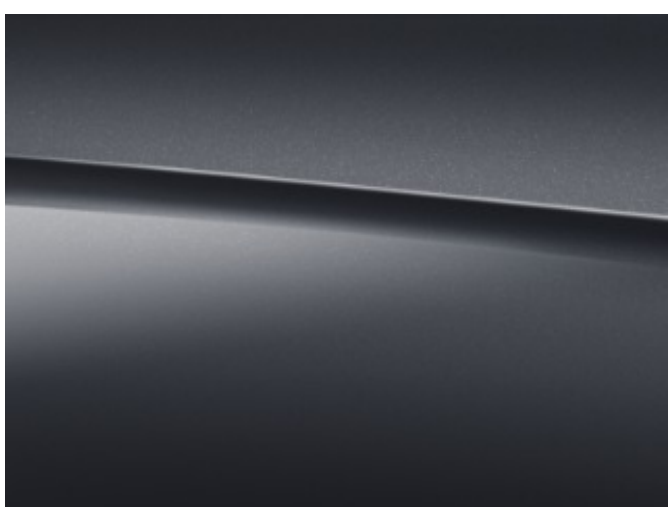

831 - Graphite Grey

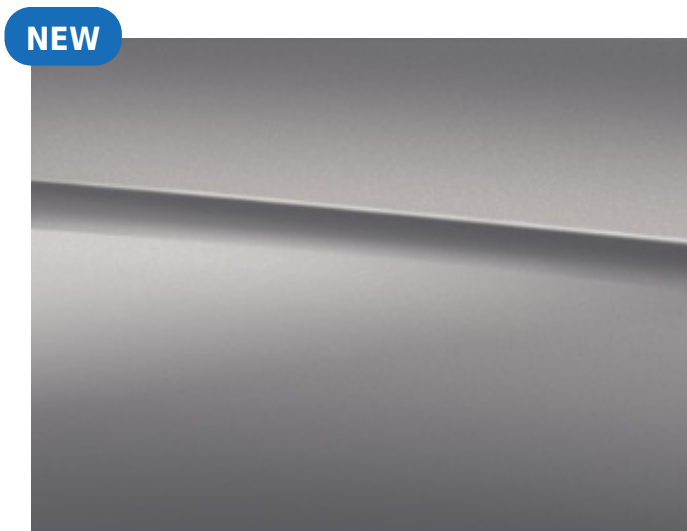

859 - Mojave Silver

## designo Paints



996 - Cardinal Red

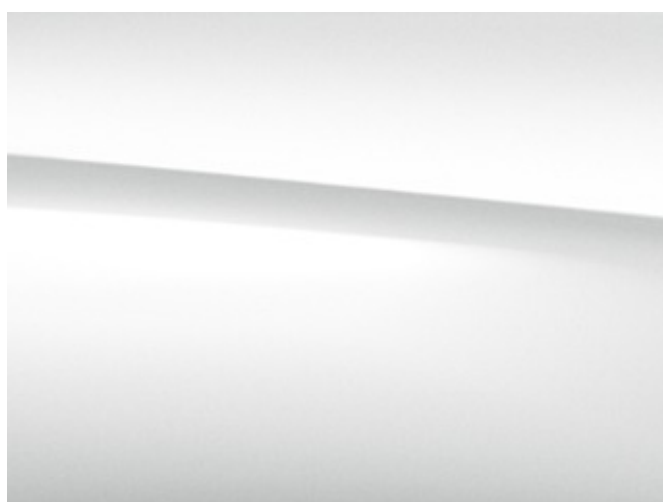

799 - Diamond White

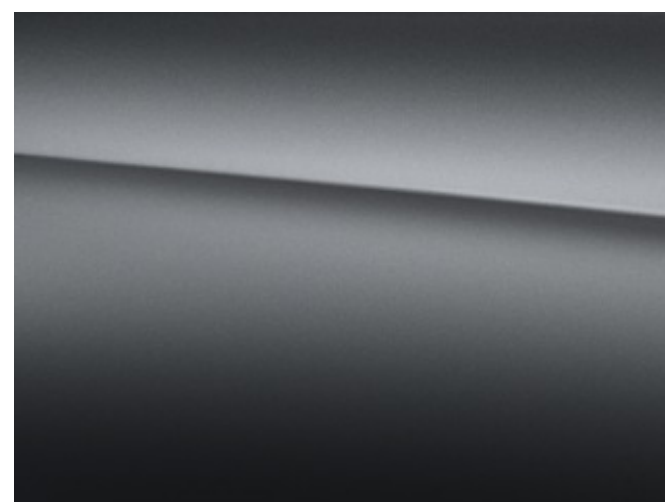

297 - Selenite Grey Magno

<i>Code</i>	<i>Description</i>	<i>Availability</i>	<i>Price</i>
040	Black	All Models	\$0
149	Polar White	All Models	\$0
197	Obsidian Black	All Models	\$720
922 (New)	Cirrus Silver	All Models	\$720
992	Selenite Grey	All Models	\$720
890	Lunar Blue	All Models	\$720
831	Graphite Grey	All Models	\$720
859 (New)	Mojave Silver	All Models	\$720
996	Cardinal Red	All Models	\$1,080
799	Diamond White	All Models	\$1,515
297	Selenite Grey Magno	All Models	\$3,950

# Wheels



**RRF - 19" AMG 5-Spoke Wheels w/ Black Accents**

19"

R02 + R66

245/40 R19 on 8 J x 19 ET 28 (Front); 275/35 R19 on 9 J x 19 ET 33 (Rear)



**RVO - 20" AMG Multispoke Wheels**

20"

R01 + R66

245/35 R20 on 8 J x 20 ET 28 (Front) 275/30 R20 on 9 J x 20 ET 33 (Rear)



**RVP - 20" AMG Multispoke Wheels w/ Black Accents**

20"

R01 + R66

245/35 R20 on 8 J x 20 ET 28 (Front) 275/30 R20 on 9 J x 20 ET 33 (Rear)



**RTY - 20" AMG Twin 5-Spoke Wheels**

20"

R01 + R66

245/35 R20 on 8 J x 20 ET 10 (Front) 275/30 R20 on 9 J x 20 ET 28 (Rear)



**RTZ - 20" AMG Twin 5-Spoke Wheels w/ Black Accents**

20"

R01 + R66

245/35 R20 on 8 J x 20 ET 10 (Front) 275/30 R20 on 9 J x 20 ET 28 (Rear)



**RZU - 20" AMG Twin 5-Spoke Wheels, Black**

20"

R01 + R66

245/35 R20 on 8 J x 20 ET 10 (Front) 275/30 R20 on 9 J x 20 ET 28 (Rear)

<i>Code</i>	<i>Wheel Size</i>	<i>Description</i>	<i>Wheel Dimensions</i>	<i>Mobility</i>	<i>Availability</i>	<i>MSRP</i>
RRF	19"		245/40 R19 on 8 J x 19 ET 28 (Front); 275/35 R19 on 9 J x 19 ET 33 (Rear)	R02 + R66	All Models	\$0
RVO	20"		245/35 R20 on 8 J x 20 ET 28 (Front) 275/30 R20 on 9 J x 20 ET 33 (Rear)	R01 + R66	All Models	\$750
RVP	20"		245/35 R20 on 8 J x 20 ET 28 (Front) 275/30 R20 on 9 J x 20 ET 33 (Rear)	R01 + R66	All Models	\$750
RTY	20"		245/35 R20 on 8 J x 20 ET 10 (Front) 275/30 R20 on 9 J x 20 ET 28 (Rear)	R01 + R66	All Models	\$750
RTZ	20"		245/35 R20 on 8 J x 20 ET 10 (Front) 275/30 R20 on 9 J x 20 ET 28 (Rear)	R01 + R66	All Models	\$750
RZU	20"		245/35 R20 on 8 J x 20 ET 10 (Front) 275/30 R20 on 9 J x 20 ET 28 (Rear)	R01 + R66	All Models	\$1,050

**CLS53C4 Notes:** CLS 53: R02: All-Season Tires; R01: High-Performance Tires; R66: MOE Tires - Extended Mobility



# Upholstery

## MB Tex



### 671 - Black MB-Tex/DINAMICA w/ Red Stitching

Standard

Choose between Red or Black Seatbelts (Y05,  
U17).

Not available with Heated & Ventilated Front  
Seats (401).

Possible to upgrade to designo Black  
DINAMICA headliner for \$1,600

## Nappa Leather



### 861 - Black Nappa Leather w/ Grey Stitching

Possible to upgrade to designo Black  
DINAMICA headliner for \$1,600



### 871 - Black Nappa Leather w/ Red Stitching

Choose between Red or Black Seatbelts (Y05,  
U17).

Possible to upgrade to designo Black  
DINAMICA headliner for \$1,600



### 875 - Macchiato Beige / Magma Grey Nappa Leather

Only with 55U or 65U headliner.  
Possible to upgrade to designo Black  
DINAMICA headliner for \$1,600



### 877 - Bengal Red / Black Nappa Leather

Possible to upgrade to designo Black  
DINAMICA headliner for \$1,600



### 878 - Magma Grey / Espresso Brown Nappa Leather

Possible to upgrade to designo Black  
DINAMICA headliner for \$1,600

## designo Nappa Leather



### 951 - Black & Titanium Grey Pearl designo Nappa leather

Requires DD1 Package. Includes designo  
Black DINAMICA Headliner (61U)



### 955 - Macchiato Beige & Titian Red designo Nappa leather

Requires DD2 Package.  
Includes designo Macchiato Beige DINAMICA  
Headliner (65U)

<i>Code</i>	<i>Description</i>	<i>Availability</i>	<i>Price</i>
671	Black MB-Tex/DINAMICA w/ Red Stitching Standard	All Models	\$0
861	Black Nappa Leather w/ Grey Stitching	All Models	\$1,600
871	Black Nappa Leather w/ Red Stitching	All Models	\$1,600
875	Macchiato Beige / Magma Grey Nappa Leather	All Models	\$1,600
877	Bengal Red / Black Nappa Leather	All Models	\$1,600
878	Magma Grey / Espresso Brown Nappa Leather	All Models	\$1,600
951	Black & Titanium Grey Pearl designo Nappa leather	All Models	\$0
955	Macchiato Beige & Titian Red designo Nappa leather	All Models	\$0

<i>Code</i>	<i>Upholstery</i>	<i>Seats</i>	<i>Floor Mats</i>	<i>Upper Dash/Lower Dash</i>	<i>Seat Belts</i>	<i>Steering Wheel</i>	<i>Headliner</i>
671	Black MB-Tex/DINAMICA w/ Red Stitching Standard	Black	Black	Black/Black	Red or Black	Black	Black Cloth
861	Black Nappa Leather w/ Grey Stitching	Black	Black	Black/Black	Black	Black	Black Cloth
871	Black Nappa Leather w/ Red Stitching	Black	Black	Black/Black	Red or Black	Black	Black Cloth
875	Macchiato Beige / Magma Grey Nappa Leather	Macchiato Beige	Macchiato Beige	Magma Grey / Macchiato Beige	Black	Macchiato Beige	Macchiato Beige Cloth
877	Bengal Red / Black Nappa Leather	Bengal Red	Black	Black / Bengal Red	Black	Black	Black Cloth
878	Magma Grey / Espresso Brown Nappa Leather	Magma Grey	Espresso Brown	Espresso Brown/Magma Grey	Black	Espresso Brown	Black Cloth
951	Black & Titanium Grey Pearl designo Nappa leather	Black	Black	Titanium Grey Pearl/Black	Black	Black	Black DINAMICA
955	Macchiato Beige & Titian Red designo Nappa leather	Macchiato Beige	Macchiato Beige	Titian Red/Macchiato Beige	Macchiato Beige	Macchiato Beige	Macchiato Beige DINAMICA

# Trims



## H01 - Light Brown Sen Wood

Includes matching Light Brown Sen wood Center Console (779)



## H05 - Natural Grain Light Brown Elm Wood

Includes matching Natural Grain Light Brown Elm wood Center Console (738)



## H06 - Brown Ash Wood

Includes matching Brown Ash wood Center Console (656)

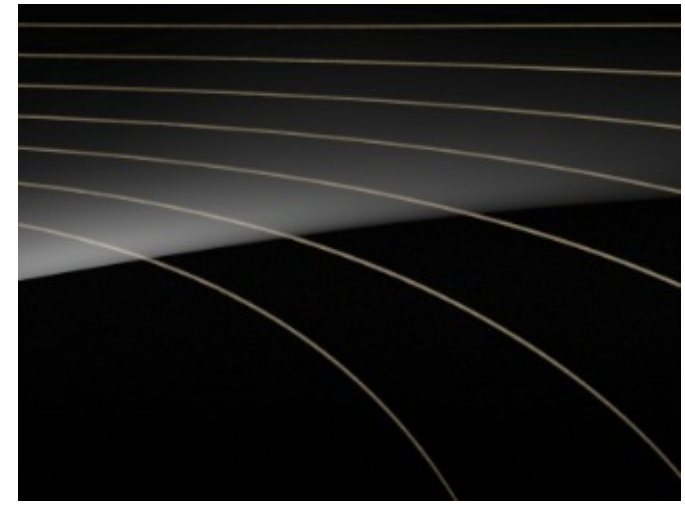

## H16 - designo Black Piano Lacquer, Flowing Lines

Includes Black Piano Lacquer Center Console (728)



## H32 - Natural Grain Grey Ash Wood

Includes matching Natural Grain Grey Ash wood Center Console (764)

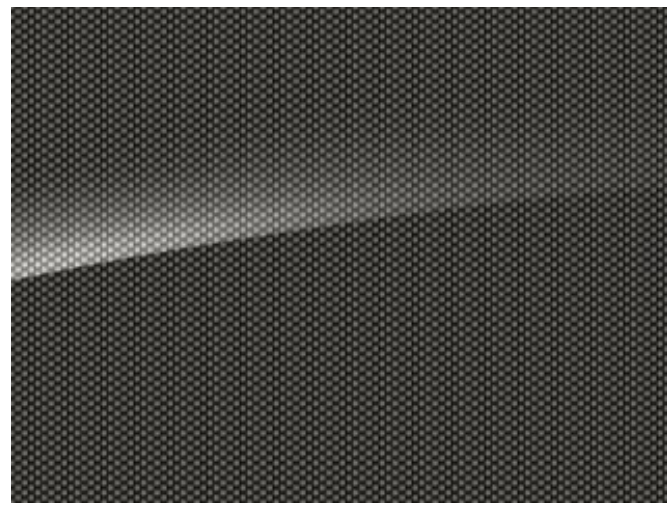

## H64 - Metal Weave

Includes Black Piano Lacquer Center Console (728)

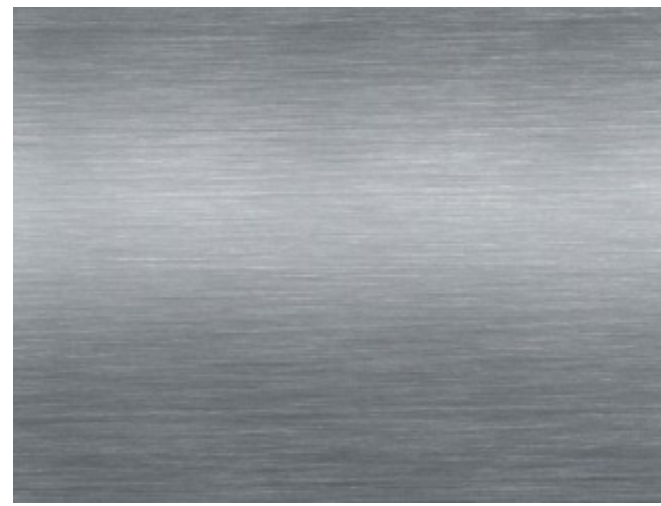

## H41 - Aluminum

Includes Black Piano Lacquer Center Console (728)

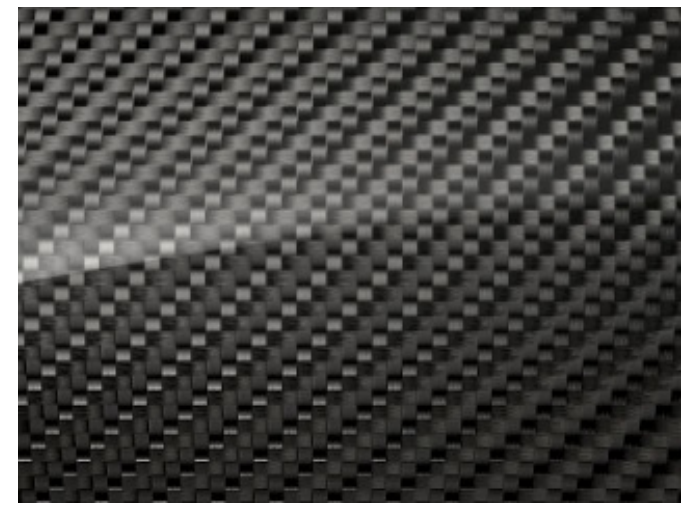

## H73 - AMG Carbon Fiber

Includes Carbon Fiber Center Console (732)

<i>Code</i>	<i>Description</i>	<i>Availability</i>	<i>Price</i>
H01	Light Brown Sen Wood Includes matching Light Brown Sen wood Center Console (779)	All Models	\$0
H05	Natural Grain Light Brown Elm Wood Includes matching Natural Grain Light Brown Elm wood Center Console (738)	All Models	\$0
H06	Brown Ash Wood Includes matching Brown Ash wood Center Console (656)	All Models	\$0
H16	designo Black Piano Lacquer, Flowing Lines Includes Black Piano Lacquer Center Console (728)	All Models	\$1,300
H32	Natural Grain Grey Ash Wood Includes matching Natural Grain Grey Ash wood Center Console (764)	All Models	\$0
H64	Metal Weave Includes Black Piano Lacquer Center Console (728)	All Models	\$600
H41	Aluminum Includes Black Piano Lacquer Center Console (728)	All Models	\$0
H73	AMG Carbon Fiber Includes Carbon Fiber Center Console (732)	All Models	\$2,850

# Packages

<i>Code</i>	<i>Packages</i>	<i>Availability</i>	<i>MSRP</i>
DA2	<p>Driver Assistance Package</p> <p>Not with Blind Spot Assist (234) or Active Brake Assist (258).</p> <ul style="list-style-type: none"> <li>▪ 20P - Driver Assistance Package Plus code</li> <li>▪ 233 - Active Distance Assist DISTRONIC®</li> <li>▪ 268 - Active Brake Assist w/ Cross-Traffic Function</li> <li>▪ 253 - PRE-SAFE® PLUS Rear End Collision Protection</li> <li>▪ 546 - Active Speed limit assist</li> <li>▪ K32 - Active Lane Change Assist</li> <li>▪ 292 - PRE-SAFE® Impulse Side</li> <li>▪ K34 - Route Based Speed Adaptation</li> <li>▪ 266 - Active Steering Assist</li> <li>▪ Active Emergency Stop Assist, Active Blind Spot Assist &amp; Active Lane Keeping Assist</li> </ul>	All Models	\$1,700
DA4	<p>Advanced Lighting Package</p> <ul style="list-style-type: none"> <li>▪ 608 - Adaptive Highbeam Assist</li> <li>▪ 640 - LED Intelligent Light System</li> <li>▪ P35 - Advanced Light Package Code</li> </ul>	All Models	\$900
DC1	<p>AMG Night Package</p> <ul style="list-style-type: none"> <li>▪ P60 - Front splitter/slats and rear diffuser trim strip insert in gloss black; black-chrome tailpipe trim elements</li> <li>▪ U50 - Omission of Dark Tinted Glass (US regulatory requirement)</li> </ul>	All Models	\$750
DC5	<p>Acoustic Comfort Package</p> <ul style="list-style-type: none"> <li>▪ 596 - Infrared Glass</li> <li>▪ PAF - Acoustic Comfort Package Code</li> </ul>	All Models	\$1,100
DD2	<p>designo Macchiato Beige / Titian Red Nappa Leather</p> <p>Not compatible with AMG Drive Unit (U88)</p> <ul style="list-style-type: none"> <li>▪ U38 - Upper dashboard and doors in designo Titian Red Nappa Leather with Titian Red topstitching</li> <li>▪ 955 - designo Macchiato Beige / Titian Red Nappa Leather seats in diamond quilt design, with Titian Red piping, and designo badge on backrests of front and rear seats</li> <li>▪ Door and center console armrests in designo Macchiato Beige Nappa Leather</li> <li>▪ 65U - designo Macchiato Beige DINAMICA headliner</li> </ul>	All Models	\$4,900
DD1	<p>designo Black / Titanium Grey Pearl Nappa Leather</p> <ul style="list-style-type: none"> <li>▪ 951 - designo Black Nappa Leather seats in diamond quilt design, with Titanium Grey Pearl piping, and designo badge on backrests of front and rear seats</li> <li>▪ Door and center console armrests in designo Black Nappa Leather</li> <li>▪ U38 - Upper dashboard and doors in designo Titanium Grey Pearl Nappa Leather with black topstitching</li> <li>▪ 61U - designo Black DINAMICA headliner</li> </ul>	All Models	\$4,900
DC4	<p>AMG Exterior Carbon Fiber Package</p> <ul style="list-style-type: none"> <li>▪ B28 - AMG Exterior Carbon Fiber Mirrors</li> <li>▪ U93 - AMG Carbon Fiber Trunk Lid Spoiler</li> </ul>	All Models	\$1,750
DB0	<p>Warmth and Comfort Package</p> <p>Not available w/ heated front seats (873)</p> <ul style="list-style-type: none"> <li>▪ 902 - Rapid Heating for Front Seats</li> <li>▪ 906 - Heated Front Armrests</li> <li>▪ P68 - Warmth &amp; Comfort Package Code</li> <li>▪ 443 - Heated Steering Wheel</li> </ul>	All Models	\$1,050

# Options

## Factory Options

<i>Code</i>	<i>Options</i>	<i>Availability</i>	<i>MSRP</i>
256	AMG Track Pace Application	All Models	\$250
401	Heated and Ventilated Front Seats Not with Black MB-Tex / DINAMICA w/ Red Stitching (671)	All Models	\$450
432	Active Multicontour Front Seats w/ Massage Feature Not with Black MB-Tex / DINAMICA w/ Red Stitching (671); Requires Warmth and Comfort Package (DB0)	All Models	\$1,320
443	Heated Steering Wheel Not with AMG Drive Unit (U88)	All Models	\$250
463	Head-Up Display	All Models	\$1,100
581	3-Zone Climate Control	All Models	\$760
811	Burmester® High-End 3D Surround Sound System (Removes Sunglasses Compartment)	All Models	\$4,550
872	Heated Rear Seats	All Models	\$580
883	Soft-close doors	All Models	\$550
61U	designo Black DINAMICA Headliner Not with 955 or 875 upholstery	All Models	\$1,600
65U	designo Macchiato Beige DINAMICA Headliner	All Models	\$1,600
L6J	AMG Performance Steering Wheel in Nappa Leather	All Models	\$0
L6K	AMG Performance Steering Wheel in Nappa Leather / DINAMICA Not with 875, 878 or 955	All Models	\$500
L6L	AMG Performance Steering Wheel in Nappa Leather / Black Piano Lacquer Only with H16, H41, H64 or H73 trim	All Models	\$600
L6G	AMG Performance Steering Wheel in DINAMICA n/a with Warmth and Comfort Package (DB0) or Heated Steering Wheel (443); requires AMG Drive Unit (U88); not with 875, 878 or 955	All Models	\$600
U78	AMG Performance Exhaust System	All Models	\$1,250
U80	115V AC Power Outlet	All Models	\$115
U88	AMG Drive Unit steering wheel buttons n/a with Warmth and Comfort Package (DB0), Heated Steering Wheel (443) or 875/878/955 upholsteries	All Models	\$400
260	Deletion of Trunk Lid Badges	All Models	\$0
261	Deletion of Fender Badges	All Models	\$0
U17	Black Seatbelts Only with 671 or 871 Upholsteries	All Models	\$0
Y05	Red Seatbelts Only with 671 or 871 Upholsteries	All Models	\$0
293	Rear Seat Side Airbags	All Models	\$700
77B (New)	MBUX Interior Assistant Not with 811; omits std. sunglasses holder	All Models	\$200
P21 (New)	Air Balance	All Models	\$350
U19 (New)	Augmented Video	All Models	\$350
21U (New)	Dashcam Requires U19	All Models	\$250

## VPC Installed Options

<i>Code</i>	<i>Options</i>	<i>Availability</i>	<i>MSRP</i>
D07	Wheel Locking Bolts	All Models	
D08	Chrome Door Handle Inserts (Set of 4)	All Models	
D33	All-weather Floor Mats	All Models	

# Specifications

CLS53C4



## Chassis

Vehicle Type	Four-door, five-passenger coupe
Chassis & Body Construction	Steel unibody with aluminum and steel body panels

## Suspension

Front Suspension	Independent multi-link suspension with air spring, single-tube shock absorber with continuously adjustable damping and torsion bar
Rear Suspension	Independent multi-link suspension with air spring, single-tube shock absorber with continuously adjustable damping and tubular torsion bar

## Drivetrain

Transmission	AMG SPEEDSHIFT TCT 9G (9 speed)
Drive Configuration	AMG Performance 4MATIC+ all-wheel drive with variable torque distribution

## Wheels and Tires

Standard Wheel Size	Front: 19" x 8" / Rear: 19" x 9"
Standard Tire Size	Front: 245/40 R19 / Rear: 275/35 R19
Standard Wheel Offset (mm)	Front: ET 28 / Rear: ET 33

## Brakes

Front Brakes	14.6" rotors w/ 4-piston calipers
Rear Brakes	14.2" rotors w/ single-piston calipers

## Engine

Engine Configuration	AMG-enhanced 3.0L inline-6 turbo with EQ Boost & Electric Aux. Compressor
Displacement (cc)	2,999
Bore (in / mm)	3.27 / 83.0
Stroke (in / mm)	3.64 / 92.4
Compression Ratio	10.5 : 1
Power (hp; Internal Combustion Engine only)	429 @ 6,100
Torque (lb-ft; Internal Combustion Engine only)	384 @ 1,800 - 5,800
EQ Boost Starter/Alternator Power & Torque	21 hp / 184 lb-ft
Fuel Requirement (Octane)	91
Fuel Tank Size (gallons)	17.4
Redline (rpm)	6,800

## Performance

Acceleration 0-60 mph (sec)	4.3 (est.)
Top Speed (mph)	130 w/ R02 Tire; 155 w/ R01 Tire (both electronically limited)

## Fuel Economy

City Fuel Economy (mpg)	TBA
Highway Fuel Economy (mpg)	TBA
Combined Fuel Economy (mpg)	TBA

## Exterior Dimensions

Vehicle Length (in.)	199.1
Vehicle Height (in.)	56.0
Vehicle Width w/ exterior mirrors (in.)	80.9
Wheelbase (in.)	113.1
Curb Weight (lbs)	TBA
Track Width Front/Rear (in.)	64.8 / 64.4

## Interior Dimensions

Cargo Capacity	11.92
----------------	-------

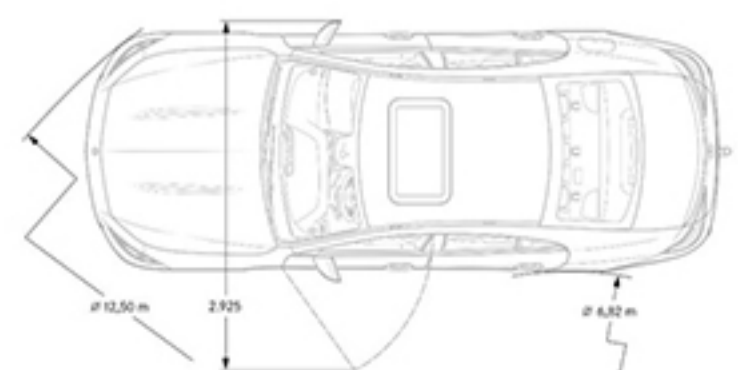
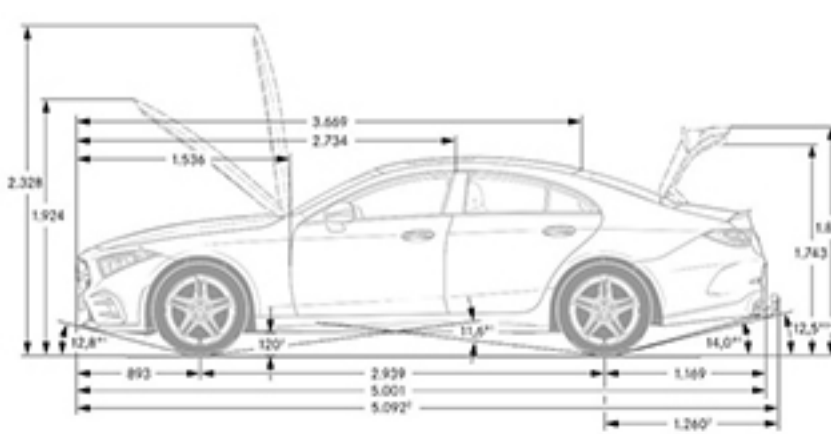
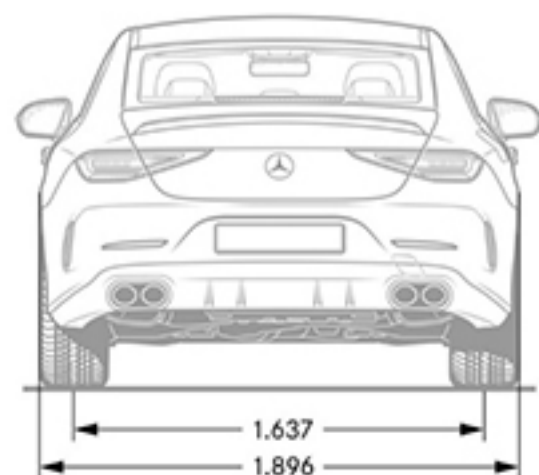
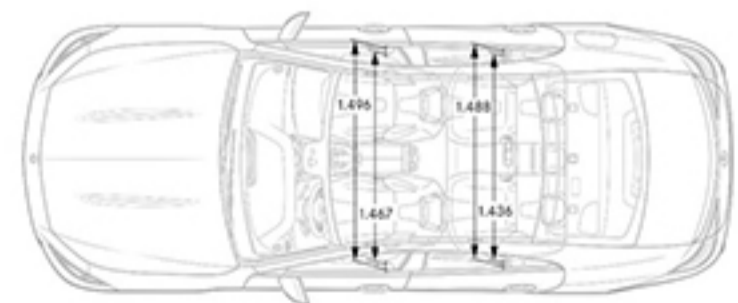
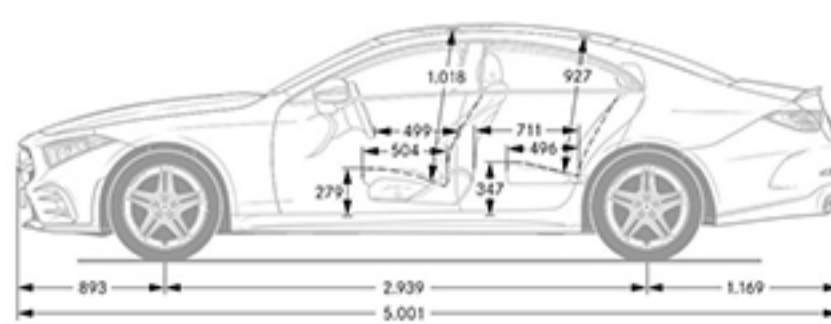
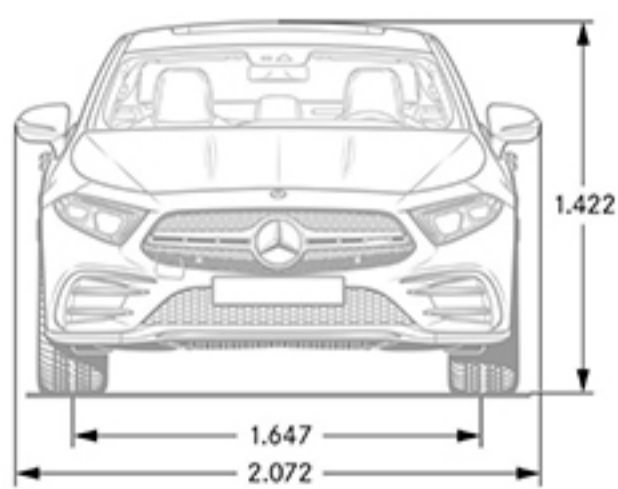

## Options In Detail

### AMG-enhanced 3.0L Inline-6 Turbo Engine w/ EQ Boost and Electric Auxiliary Compressor (M256)

The M256 engine found in AMG "53" models provides exceptional power output thanks to exciting new technologies:

#### **EQ Boost:**

- The M256 utilizes a 48V system to provide power to the electric water pump, AC compressor, Electric Auxiliary Compressor. With these components now being electrified, the engine is now fully beltless, reducing wearable parts.
- EQ Boost makes use of the stored electric power from the 48V battery with an "Integrated Starter-Generator" which combines the starter and alternator in a powerful electric motor which is positioned between the engine and transmission. This EQ Boost unit assists the internal combustion engine with up to 21 hp and 184 lb-ft of torque at low engine speeds.
  - Please note that this boost in hp / torque never impacts the certified peak power figures, as the boost is generated at such low engine speeds, and only for brief periods of time.
- On overrun, EQ Boost is able to recover up to 80 percent of the energy to the 48V battery.
- The engine is able to start very quietly by utilizing stored power in the 48V battery. ECO Start/Stop is also almost imperceptible now that it uses the EQ Boost system.
  - Please note that the 48V battery is small- it is a little less than 1 kWh in capacity.
- The conventional 12V battery is still used by the vehicle and is charged by the 48V battery. Most electrical vehicle components remain wired for 12V and thus, the 12V battery is used to provide power for cabin lights, exterior lighting, the multimedia system, etc.

#### **Electric Auxiliary Compressor:**

- This new engine component (exclusive to the "53" models) is able to assist in spooling the engine's exhaust-gas-driven turbocharger quickly and effectively at low-to-mid RPMs. Able to get up to speeds of 70,000 RPMs within less than a third of a second, the eAC is extremely quick to provide added boost. This allows a much larger turbocharger to be employed in this version of the M256. In some cases, boost from the Electric Auxiliary Compressor is able to be routed directly to the engine itself.
- In one minute, the Electric Auxiliary Compressor is able to function three times for two seconds, or one time for 15 seconds.



### Steering Wheels

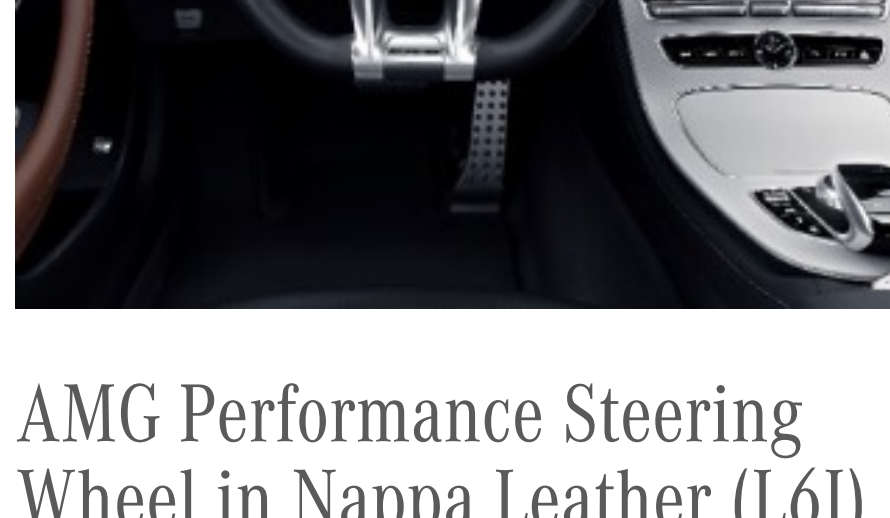

#### AMG Performance Steering Wheel in Nappa Leather (L6J)

Image for illustrative purposes only

Standard

The AMG Performance Steering Wheel in Nappa Leather is especially sporty with easy grip, providing genuine racing flair.

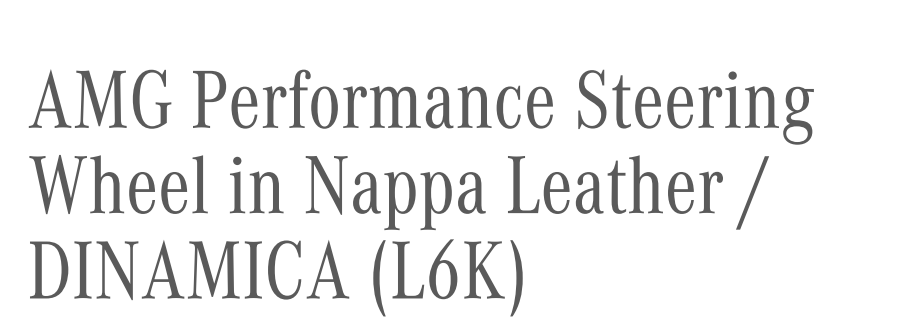

#### AMG Performance Steering Wheel in Nappa Leather / DINAMICA (L6K)

Optional: \$500

Sporty design and unique touch & feel make the AMG Performance Steering Wheel an unmistakable feature in Nappa Leather with the grip area in DINAMICA.

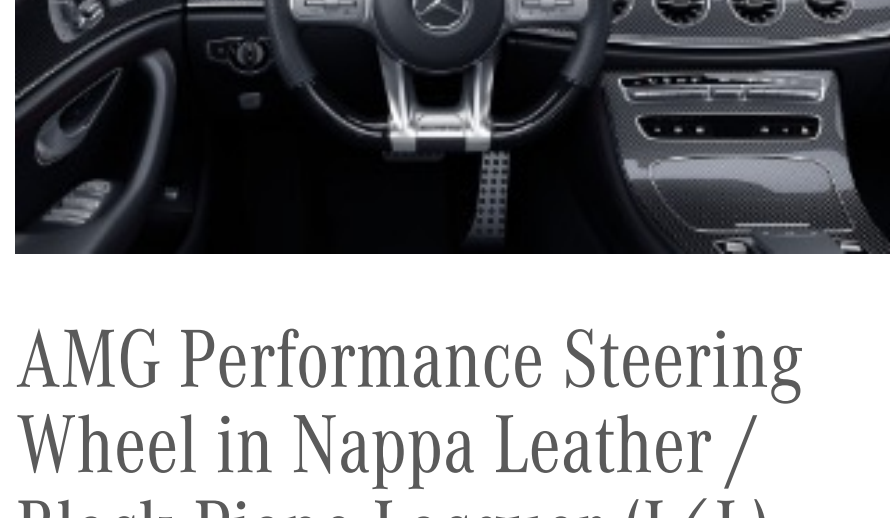

#### AMG Performance Steering Wheel in Nappa Leather / Black Piano Lacquer (L6L)

Optional: \$600

The combination of Nappa Leather with Black Piano Lacquer makes the steering wheel a highlight in terms of its look and feel.

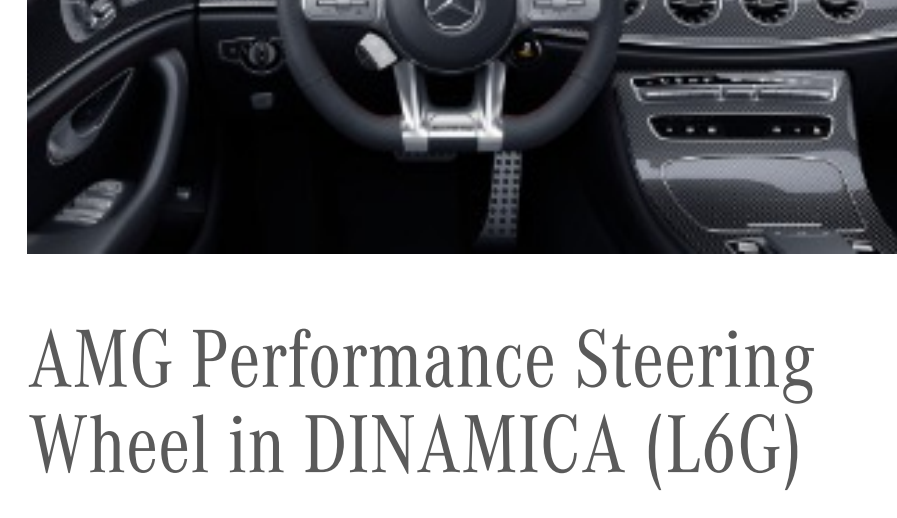

#### AMG Performance Steering Wheel in DINAMICA (L6G)

Optional: \$900

This AMG Performance Steering Wheel is completely finished in non-slip DINAMICA – for a perfect grip and precise steering. The flattened shape typical of AMG has been adopted from motorsport, and underlines the sportiness of the cockpit.

### AMG Drive Unit Steering Wheel Buttons (U88): \$400

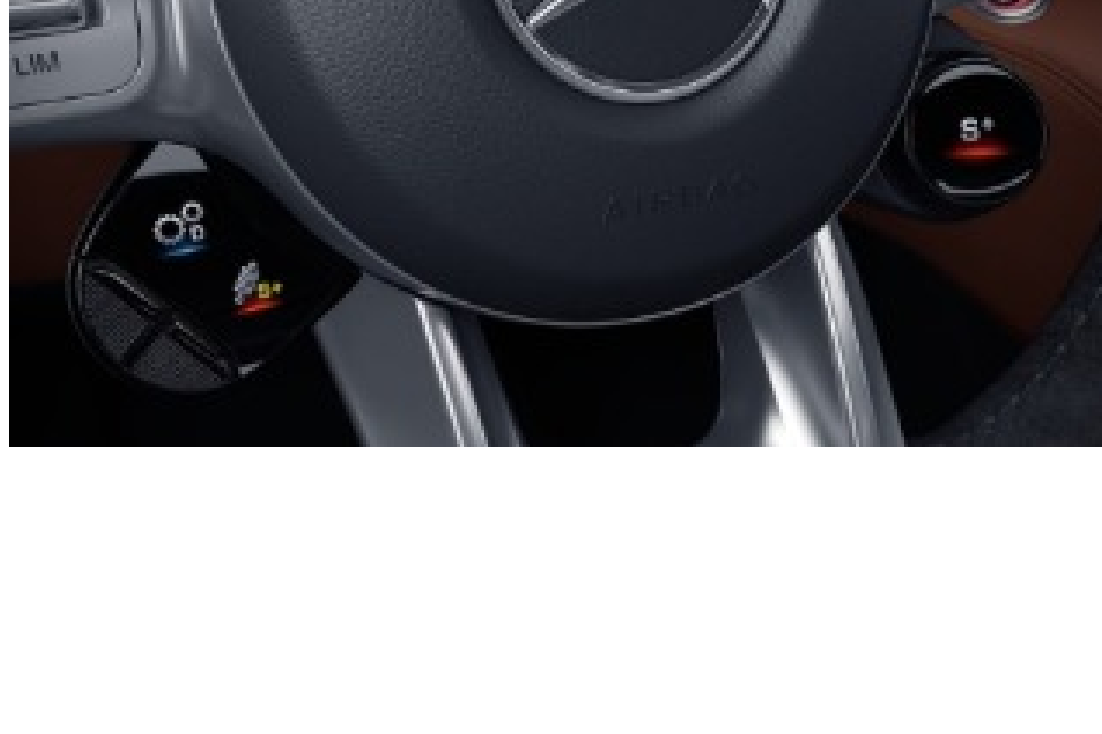

When U88 is selected, the AMG Performance Steering Wheel is equipped with a round control wheel spoke, plus two vertically positioned color display buttons beneath the left-hand steering-wheel spoke. The round display allows for easy adjustment of the AMG DYNAMIC SELECT Drive Mode.

The vertically-mounted displays offer a configurable hot-key to adjust two key parameters, i.e. a switch to Manual transmission mode (or to Automatic shifting) or a switch from the Comfort exhaust setting to the more emotional Sport setting.

These buttons allow the driver to concentrate fully on dynamic driving without having to take their hands off the wheel in order to change performance-oriented vehicle settings.

Please note that AMG Drive Unit Steering Wheel Buttons are not able to be equipped in conjunction with Warmth and Comfort Package (DB0) or Heated Steering Wheel (443).

AMG Drive Unit Steering Wheel Buttons are required in conjunction with AMG Performance Steering Wheel in DINAMICA (L6G).

Additionally, AMG Drive Unit Steering Wheel Buttons are not available in conjunction with any upholstery that has a steering wheel that is not Black (upholsteries 875/878/955).

### AMG Night Package (DC1): \$750

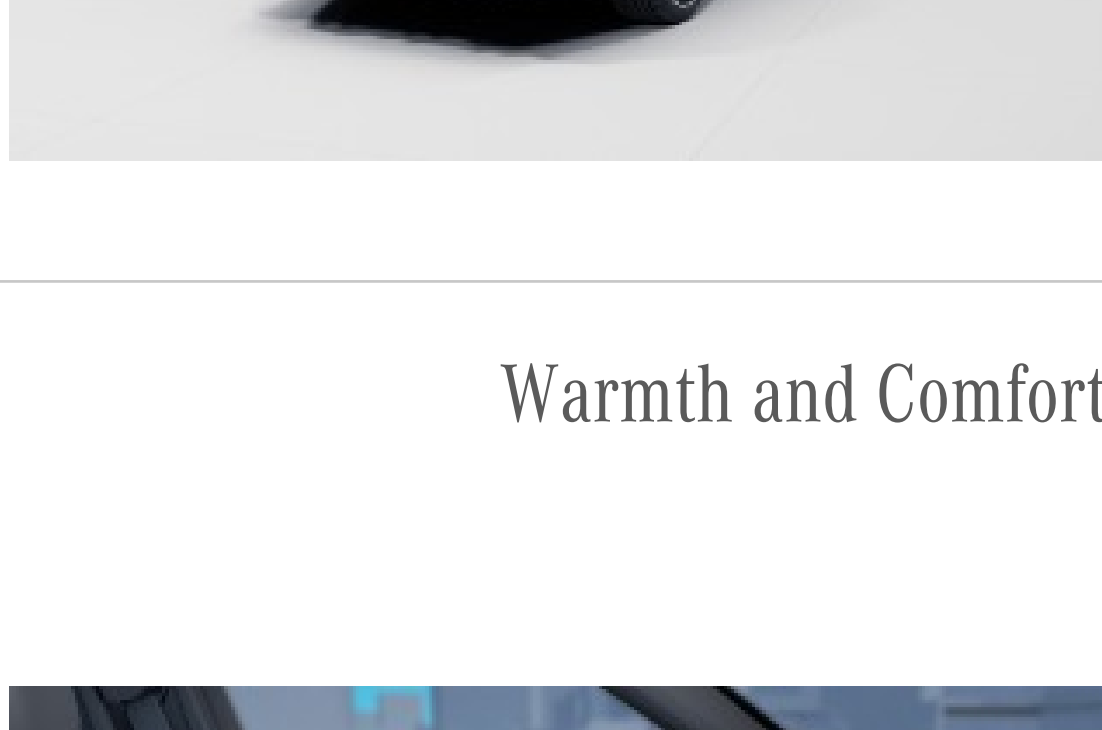

With the AMG Night Package, selected exterior elements are finished in high-gloss black. Depending on the selected paint color, this results in bold contrasts or fluid transitions.

#### **Package includes:**

- Exterior elements in high-gloss black:
  - Front splitter
  - Outer air intakes in the AMG front bumper
- Two black chrome-plated round twin tailpipes

### Warmth and Comfort Package (DB0): \$1,050

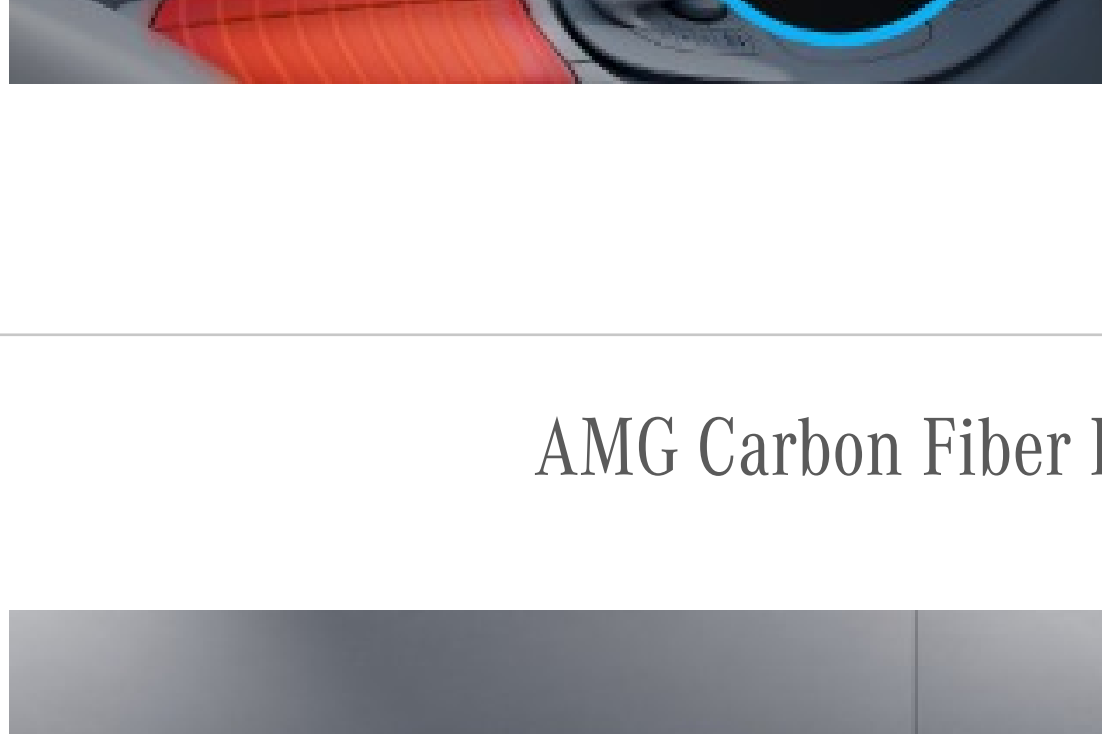

Enjoy pleasant temperatures in the shortest of time, even on cold days: the intelligently combined heating elements are particularly fast-acting and warm the back, arms and legs. This means you and your front passenger won't be cold, even when the interior is not fully warmed up.

#### **Package Includes:**

- Heated Steering Wheel
- Rapid Heating Functionality for Front Seats
- Heated Front Armrests

Please note that the Warmth and Comfort Package is not available with AMG Drive Unit (U88) or Black MB-TEX / DINAMICA Upholstery (671).

Warmth and Comfort Package requires Heated and Ventilated Front Seats (401)

### AMG Carbon Fiber Package (DC4): \$1,750



High-performance material meets high-performance car: the carbon-fiber features for the exterior underline the character of your Mercedes-AMG, and lend it an even more sporty look.

#### **Package Includes:**

- Exterior mirror housing in carbon fiber
- AMG spoiler lip in carbon fiber

### AMG Track Pace COMAND App (256): \$250



AMG TRACK PACE transforms your AMG vehicle into your virtual race engineer. With the aid of lap, sector and acceleration times plus selected live telemetrics data, you can analyze and improve your driving skills on cordoned-off tracks in a purposeful manner.

In order to determine as precise a position as possible, AMG TRACK PACE works with a specially programmed algorithm which combines vehicle data such as wheel speed, steering angle and yaw rate with the satellite-aided GPS positioning system and updates every 50 milliseconds (20 Hz technology). This makes position measurement significantly more precise than with external applications such as third-party-provider apps on the smartphone.

In order to record and continually improve your individual performance, recorded data such as lateral and longitudinal acceleration, accelerator and brake pedal position or steering angle are used. All values are clearly depicted and can be read out directly in the vehicle. Fast to slow laps can be noted from the corner of the eye thanks to various color displays.

As well as recording drives on circuits or public routes, AMG TRACK PACE can also be used to record acceleration such as from a standstill to 60 mph or over a quarter mile plus deceleration values.

AMG TRACK PACE app is only intended for use on closed-off circuits.

Photos for illustration only; interior configuration may differ, and different AMG model may be shown.

### Burmester High-End 3D Sound System (811): \$4,550



Sound on a par with that of luxury home music systems. Speakers in the roof liner compose a three-dimensional sound. They conduct the system like your personal orchestra – with VIP settings for individual seats or style specifications such as "Live" or "Easy Listening".

The basis is provided by the high-end DSP amplifier, the output power of which is perfectly matched to the speaker systems. Including the speakers in the roof liner there are 25 high-performance speakers with a system output of 1,450 watts, meeting practically any sound requirement. Sophisticated vehicle noise compensation (VNC) adjusts music and sound dynamically to your driving conditions. With the fader and balance function, you can distribute the sound more to the front, rear or equally to all seats – or focus the listening experience to a seat of your choice with the Sound Focus function. The Equalizer function can be set to suit your tastes, allowing individual adjustment of high, medium and low frequencies.

Please note that this option omits the standard sunglasses holder.

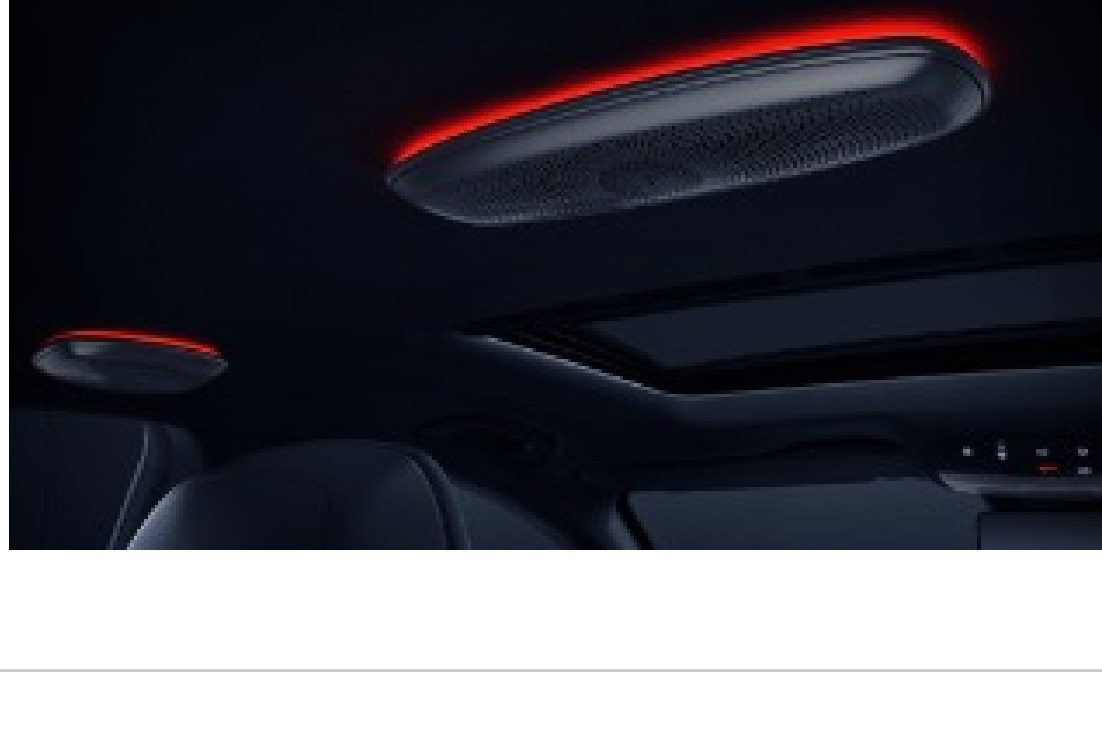

### MBUX Infotainment and Navigation System



The Mercedes-Benz User Experience infotainment system (MBUX) found in the CLS is the latest and most advanced user experience system implemented in a Mercedes vehicle to date.

Featuring a touchscreen, touchpad on the center console, touch-control buttons on the steering wheel and an advanced voice control system / virtual assistant ("Hey Mercedes"), MBUX provides occupants of the CLS with an immersive user experience both inside and outside the vehicle.

A unique feature of this system is its ability to learn thanks to artificial intelligence. MBUX can be individualized and adapts to suit the user. It thus creates an emotional connection between the vehicle, driver and passengers. At the same time updates "over the air" are possible. It also heralds a new era at Mercedes: Mercedes Connectivity.

The MBUX system features two large 12.3" screens as standard, which are arranged in-line with each other for an impressive wide-screen look. The information of the Instrument Cluster Display and the multimedia display is easily legible on the large, high-resolution screens.

### MBUX Interior Assistant (77B): \$200

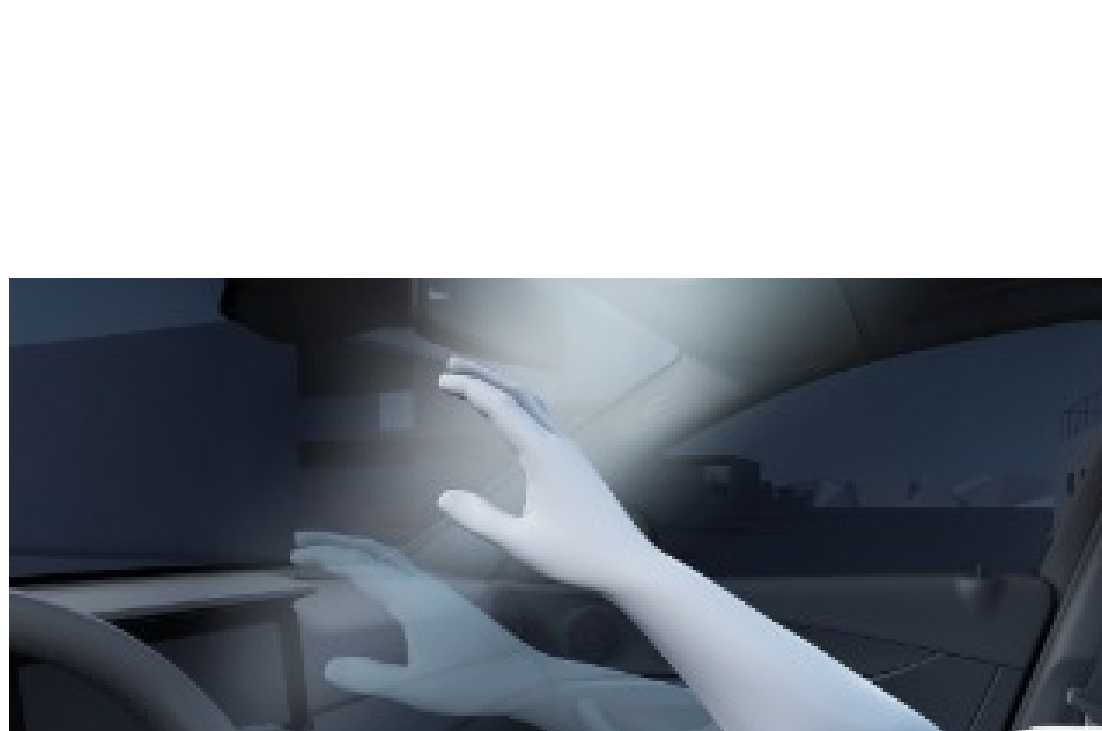

#### **N/A w/ 811; omits sunglasses holder**

The advanced 3D camera system makes operation easier for driver and front passenger by identifying when their hand is approaching and by providing lighting assistance and quick access to favourites. For this it assesses your hand movements in the area between the media display and touchpad. In practice this means: as soon as your hand gets close to the touchpad or touchpad, the MBUX Interior Assist enlarges certain control elements on the media display or highlights them. This applies to the menus for the home screen, radio/media, map navigation, Active Parking Assist and seat adjustment.

The advantages: in the case of the active seat menu, the functions for the driver or front passenger seat are shown immediately. The desired seat is preselected by the assistant. With active parking assistance, you can quickly switch between different camera views. Especially elegant: to call up your personal favourites menu, simply make a "V" with your index and middle fingers. In the dark, you can switch on the reading lamp without wasting time fumbling around by moving your hand up and down near the underside of the rear-view mirror. By repeating this gesture, you can also just as easily switch the reading lamp off again. Or you can activate the search light by pulling for the unoccupied front passenger seat. As soon as you reach your hand back again, the light is switched off again.

### Dash Cam (21U): \$250

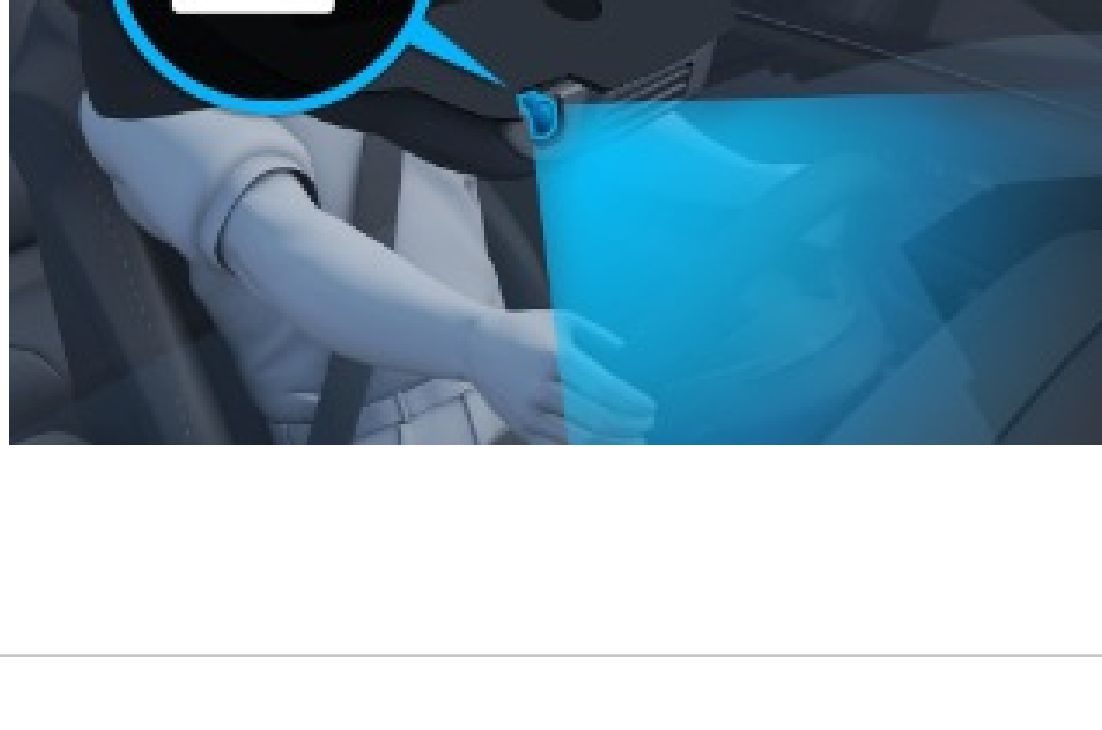

The dash cam films and saves what's happening on the road in front of your vehicle – and also records the time and speed. This can help you in documenting the sequence of events in an accident, for example, and provide you with supporting evidence if necessary. Or you can hold on to landscapes and routes which are worth seeing and create your own automotive travel diary.

Recordings are made on a USB stick connected to the Media Interface slot. You can choose from two settings via the media display, the Touch Control buttons or the touchpad: the dash cam can stop recording when the touchpad has been reached, or can automatically overwrite older data. You can then export the video material on the media display in the vehicle (when stationary) or on a computer at home.

Recording of videos with a resolution of 1280 x 720 pixels (720p) and a frame rate of 30 Hz

### "Hey Mercedes" Virtual Assistant

Experience and enjoy voice control at a fascinating new level – fixed commands are a thing of the past. Thanks to its comprehension of natural speech, the LINGUATRONIC in MBUX obeys practically every word. It recognises and understands almost every sentence occurring in the infotainment functions and vehicle operation. The system can also process indirect speech – the air conditioning for example will already respond to "I feel cold" and gradually increase the temperature setting.

At the same time the voice control also has learning capability. It attunes itself to your voice, and also understands non-native speakers better. The software models on the server also learn new in-words or changes in use of language over time. Moreover, the system no longer gives stereotyped answers, but also varies its speech output. Another advantage is that if you enter characters on the touchpad, LINGUATRONIC can output them acoustically if you wish.

Your mood is always the main focus. Individually stored theme displays include the DYNAMIC SELECT driving modes, radio stations, optional ambient lighting and much more. The so-called predictive functions are even more diverse – for example: a driver who frequently telephones his mother on the way home on Tuesdays will be prompted to do so on that day of the week by the telephone number appearing in the display. This artificial intelligence gradually turns the car into your personal assistant.



# Build Recommendations

**CLS53C4** MSRP \$81,550



<b>Exterior Color</b>	040 Black	\$0
<b>Wheel</b>	RTZ 20" AMG Twin 5-Spoke Wheels w/ Black Accents	\$750
<b>Upholstery</b>	671 Black MB-Tex/DINAMICA w/ Red Stitching	\$0
<b>Trim</b>	H32 Natural Grain Grey Ash Wood	\$0
<b>Standalone Options</b>	443 Heated Steering Wheel	\$250
<b>Package</b>	DA4 Advanced Lighting Package DA2 Driver Assistance Package	\$900 \$1,700
<b>Estimated MSRP 1</b>		\$85,150

<b>Exterior Color</b>	799 Diamond White	\$1,515
<b>Wheel</b>	RVO 20" AMG Multispoke Wheels	\$750
<b>Upholstery</b>	871 Black Nappa Leather w/ Red Stitching	\$1,600
<b>Trim</b>	H32 Natural Grain Grey Ash Wood	\$0
<b>Standalone Options</b>	401 Heated and Ventilated Front Seats 443 Heated Steering Wheel U78 AMG Performance Exhaust System	\$450 \$250 \$1,250
<b>Package</b>	DA4 Advanced Lighting Package DA2 Driver Assistance Package	\$900 \$1,700
<b>Estimated MSRP 2</b>		\$89,965

<b>Exterior Color</b>	831 Graphite Grey	\$720
<b>Wheel</b>	RZU 20" AMG Twin 5-Spoke Wheels, Black	\$1,050
<b>Upholstery</b>	877 Bengal Red / Black Nappa Leather	\$1,600
<b>Trim</b>	H64 Metal Weave	\$600
<b>Standalone Options</b>	256 AMG Track Pace Application 401 Heated and Ventilated Front Seats 463 Head-Up Display L6K AMG Performance Steering Wheel in Nappa Leather / DINAMICA U78 AMG Performance Exhaust System U88 AMG Drive Unit steering wheel buttons	\$250 \$450 \$1,100 \$500 \$1,250 \$400
<b>Package</b>	DA4 Advanced Lighting Package DA2 Driver Assistance Package DC1 AMG Night Package	\$900 \$1,700 \$750
<b>Estimated MSRP 3</b>		\$92,820

# Gallery

All

Exterior

