

72-100 Removal and installation of door liner

Operation no. of operation texts and work units or standard texts and flat rates:

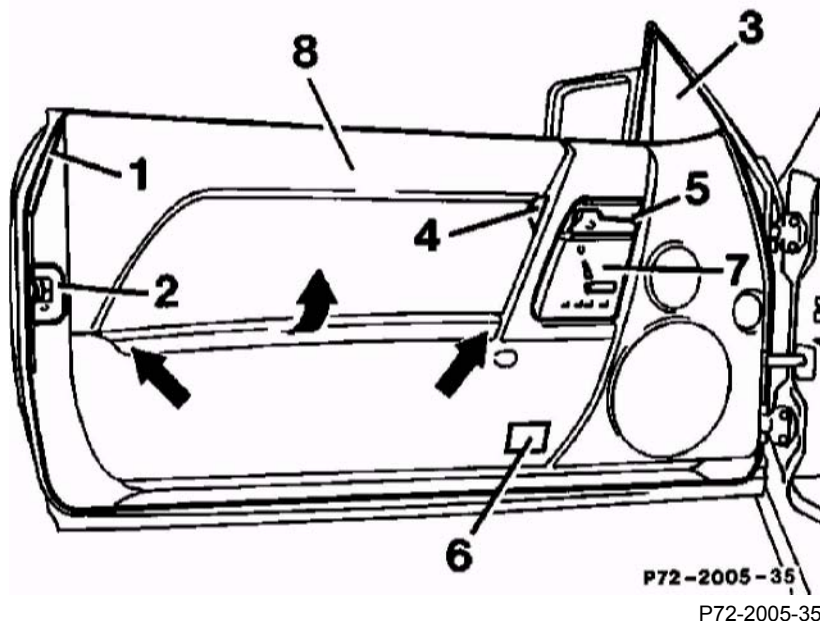

- Screws on chrome trim (1) 3 each
- Screw on lock cover plate (2)
- Lock cover plate (2)
- Cover (3) on mirror triangle
- Knob (4) for interior locking mechanism
- Small wood cover (5) on inside door control
- Door pocket cover
- Front cover (arrow)
- Entry light (6)

- Frame on inside door control
- Large wood cover (7)
- Electrical connections on seat control switch
- Screw on inside door control
- Screw in area of door pocket, front (arrow)
- Screw in area of door pocket, rear (arrow)
- Door liner (8)

- Door liner (8)

- Vacuum line and electrical wires on door liner
- Door liner (8)
- Before installing door liner
- Install

- screw out and remove chrome trim.
- screw out.
- pull down and remove.
- press off and remove toward top.
- press off and pull out.
- press off and remove
- open
- press off and remove.
- pull out downward, pull off electrical connections and lay light to side.
- screw off and remove.
- press to the rear and remove from door liner.
- disconnect and lay wood cover (7) aside.
- screw out (10 mm wrench).
- screw out.
- screw out.
- unclip from inside door panel at bottom as well as front and back (8 clips).
- pull away from inside door panel at bottom and remove toward top.
- disconnect and pull through.
- lay aside.
- check door foil for damage, replace if required.
- in opposite order.

Removal, installation

- 1 Screw out screw on chrome trim and lock cover plate.
- 2 Remove chrome trim and lock cover plate.

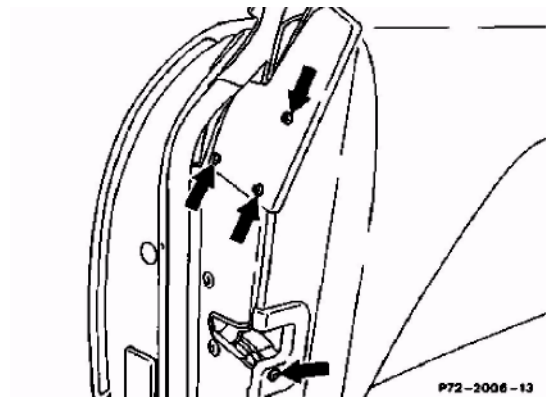

P72-2006-13

- 3 Press cover off of mirror triangle and remove upward.

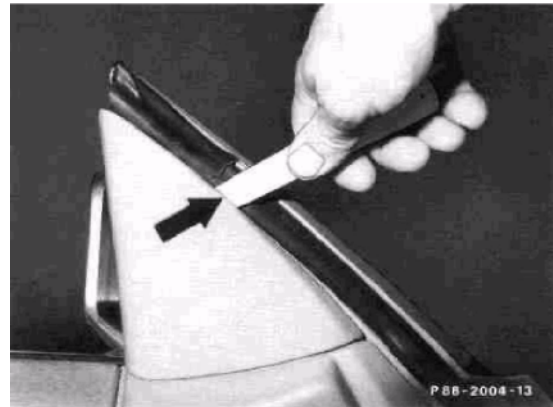

P72-2004-13

- 4 Press off small wood cover and knob for inside locking mechanism and remove (arrows).

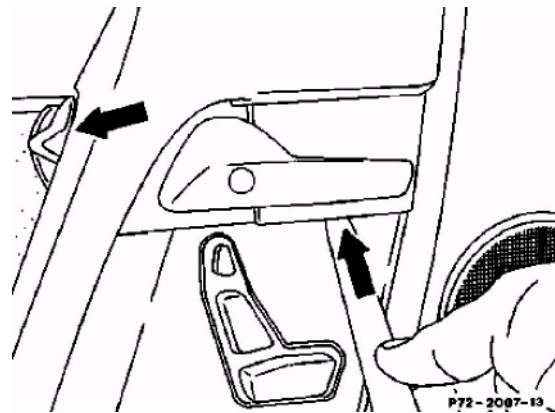

P72-2007-13

5 Open door pocket cover and press off front cover (arrow).

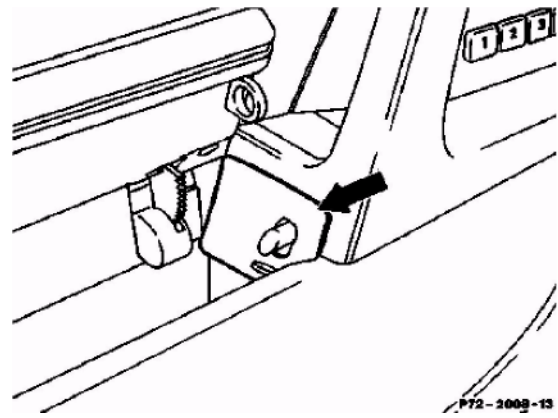

P72-2008-13
P72-2008-13

6 Pull out entry light downward. Disconnect electrical connections and lay light aside.

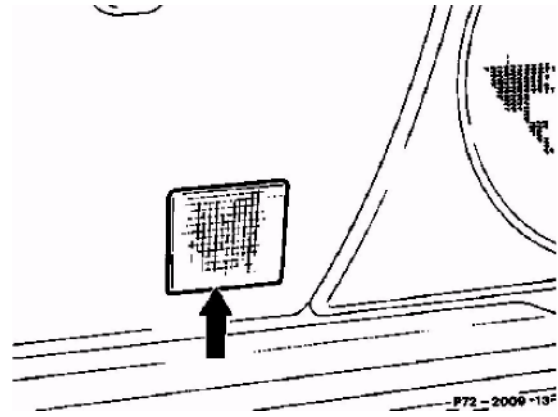

P72-2009-13
P72-2009-13

7 Screw frame off of inside door control and remove (arrow).

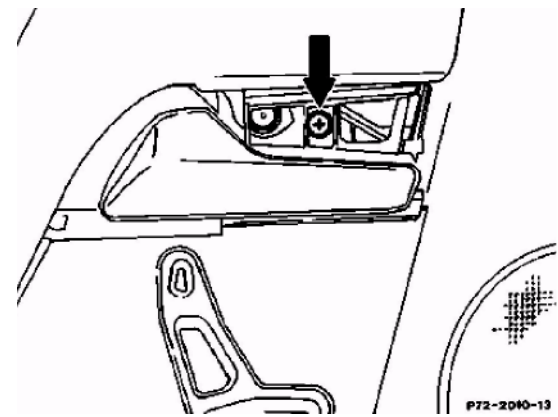

P72-2010-13
P72-2010-13

8 Press large wood cover downward and remove from door liner (arrows).

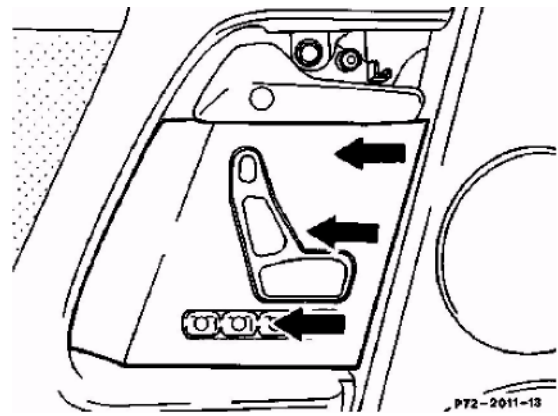

P72-2011-13

9 Disconnect plug connector and lay wood cover to side (arrow).

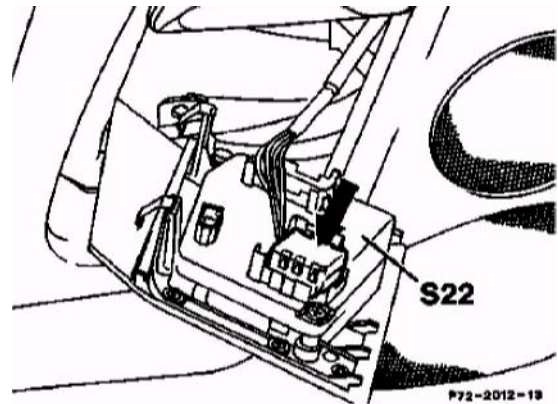

P72-2012-13

10 Screw out screw on inside door control (arrow).

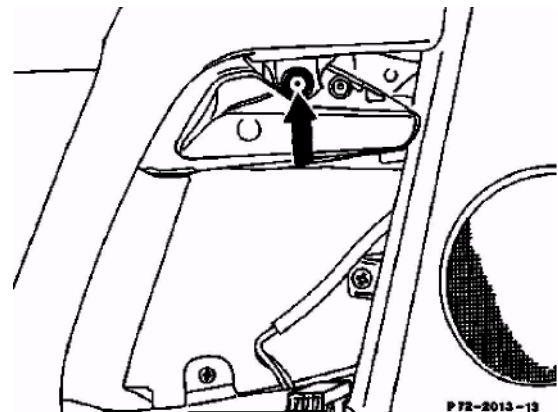

P72-2013-13

11 Screw out screw at front of door pocket (arrow).

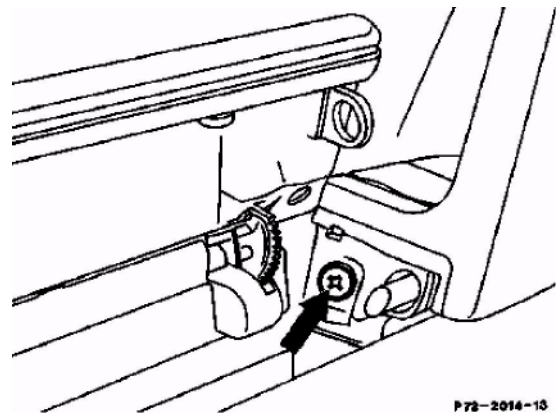

P72-2014-13

P72-2014-13

12 Screw out screw at rear of door pocket (arrow).

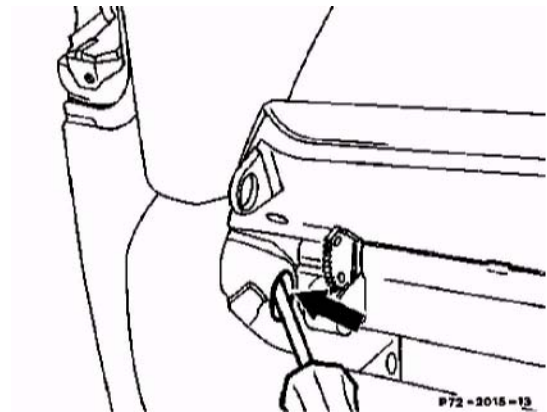

P72-2015-13

P72-2015-13

13 Pull door liner off of inside door panel at bottom, front and rear. Pull door liner away from inside door panel at bottom and remove upward (arrows).

14 Disconnect vacuum line and electrical wiring on door liner.

15 Lay door liner to side.

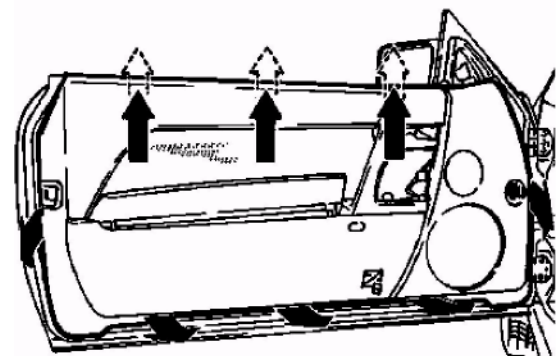

P72-2018-13

P72-2018-13

- 16 Before installing door liner check door foil. Replace foil if damaged and glue on without wrinkles.
- 17 Install in reverse order.

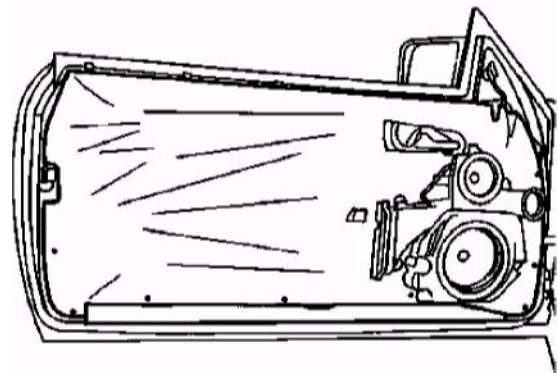

P72-2020-13

P72-2020-13

Rear side of door liner showing position of clips (8 each, arrows).

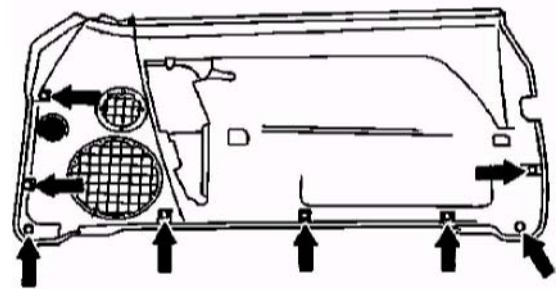

P72-2019-13

P72-2019-13