

ENGINES 112 (except 112.912 /946 /961)

ENGINES 112

ENGINES 113

ENGINES 113 (except 113.968 /963 /992)

Shown on engine 112

- 1 Oil pan bottom section
 2 Oil-level sensor screws
 3 Plug for oil level sensor
 S43 Oil level sensor

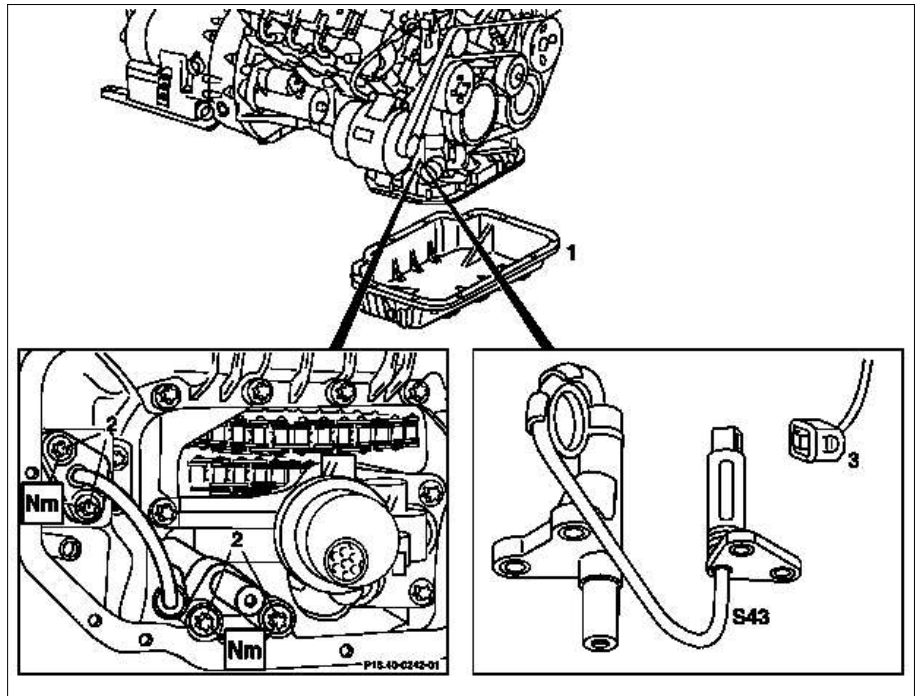

P18.40-0241-06

Modification notes

20.12.04	Engine oil filling capacity with oil filter modified.	Engine 113.967	*BF18.00-P-1001-01H
----------	---	----------------	-------------------------------------

	Remove/install		
	Risk of death caused by vehicle slipping or toppling off of the lifting platform.	Align vehicle between the columns of the lifting platform and position the four support plates at the lifting platform support points specified by the vehicle manufacturer.	AS00.00-Z-0010-01A
1	Extract/drain engine oil	 Engine oil extractor Gotis://S_18.1_0	*BA01.45-P-1003-01B *BF18.00-P-1001-01H
2	Remove lower part of oil pan (1)	Model 129, 170, 202, 208, 210, 220, 463 Model 163.154, 163.172 Model 163.174	AR01.45-P-7555VA AR01.45-P-7555V AR01.45-P-7555VE
3	Unplug connector (3) at oil level sensor		
4	Remove screw/bolts for oil level sensor (2)		*BA18.40-P-1002-01B
5	Remove oil level switch (S43)		
6	Install in the reverse order		

Oil pan

Number	Designation	Engine	Engine
		112.910/911/ 912/913/914/ 915/917/920/ 921/922/923/ 940/941/942/ 943/944/945/ 946/947/949/ 951/954/955/ 960/961/970/ 972/973/976	112.916/953/975 , 113.948/966

BA01.45-P-1003-01B	Oil drain screw on oil pan	M14	Nm	30	30
--------------------	----------------------------	-----	----	----	----

Nm Oil pan

Number	Designation	Engine 113.940/941/ 942/943/944/ 945/946/960/ 961/962/963/ 965/967/968/ 969/980/981/ 982/984/986/ 992/995	Engine 113.987/ 988/991	Engine 113.990		
BA01.45-P-1003-01B	Oil drain screw on oil pan	M14	Nm	30	30	30

Nm Oil level/oil pressure sensor

Number	Designation	Engine 113.940/941/ 942/943/944/ 945/946/960/ 961/962/963/ 965/967/968/ 969/980/981/ 982/984/986/ 992/995	Engine 112 except 112.916/951/953 /975	
BA18.40-P-1002-01B	Oil level sensor on oil pan top section	Nm	10	10

Nm Oil level/oil pressure sensor

Number	Designation	Engine 113.987/ 988/990	Engine 113.991/ 993	
BA18.40-P-1002-01B	Oil level sensor on oil pan top section	Nm	10	9

Engine lubrication

Number	Designation	Engine 112 (shortened maintenance interval) except 112.916/953/975	Engine 112 (maximum maintenance interval) except 112.916/953/975	
BF18.00-P-1001-01H	Engine oil Filling capacity with oil filter	Liters	8.0	8.0

	Filling capacity without oil filter	Liters	7.5	7.5
	Specifications for Operating Fluids	Sheet	BB00.40-P-0229-01A	-
		Sheet	BB00.40-P-0229-03A	-
		Sheet	BB00.40-P-0229-05A	BB00.40-P-0229-05A

 Engine lubrication

Number	Designation		Engine 112.916/953 (shortened maintenance interval)	Engine 112.916/953 (maximum maintenance interval)	
BF18.00-P-1001-01H	Engine oil	Filling capacity with oil filter	Liters	7.5	7.5
		Filling capacity without oil filter	Liters	7.0	7.0
	Specifications for Operating Fluids	Sheet	BB00.40-P-0229-01A	-	
		Sheet	BB00.40-P-0229-03A	-	
		Sheet	BB00.40-P-0229-05A	BB00.40-P-0229-05A	

 Engine lubrication

Number	Designation		Engine 112.975 (shortened maintenance interval)	Engine 112.975 (maximum maintenance interval)	
BF18.00-P-1001-01H	Engine oil	Filling capacity with oil filter	Liters	8.0	8.0
		Filling capacity without oil filter	Liters	7.5	7.5
	Specifications for Operating Fluids	Sheet	BB00.40-P-0229-01A	-	
		Sheet	BB00.40-P-0229-03A	-	
		Sheet	BB00.40-P-0229-05A	BB00.40-P-0229-05A	

 Engine lubrication

Number	Designation		Engine 113.940/941/942/943/960/961/962/969/982 (shortened maintenance interval)	Engine 113.940/941/942/943/960/961/962/969/982 (maximum maintenance interval)	Engine 113.944/980/981/984/986/991	
BF18.00-P-1001-01H	Engine oil	Filling capacity with oil filter	Liters	8.0	8.0	7.5
		Filling capacity without oil filter	Liters	-	-	-

	Specifications for Operating Fluids	Sheet	BB00.40-P-0229-01A	-	-
		Sheet	BB00.40-P-0229-03A	-	-
		Sheet	BB00.40-P-0229-05A	BB00.40-P-0229-05A	BB00.40-P-0229-05A

 Engine lubrication

Number	Designation	Engine 113.948/966 (shortened maintenance interval)	Engine 113.948/966 (maximum maintenance interval)	
BF18.00-P-1001-01H	Engine oil	Filling capacity with oil filter Liters	8.0	
		Filling capacity without oil filter Liters	7.5	
	Specifications for Operating Fluids	Sheet	BB00.40-P-0229-01A	-
		Sheet	BB00.40-P-0229-03A	-
		Sheet	BB00.40-P-0229-05A	BB00.40-P-0229-05A

 Engine lubrication

Number	Designation	Engine 113.963/965/968 (shortened maintenance interval)	Engine 113.963/965/968 (maximum maintenance interval)	
BF18.00-P-1001-01H	Engine oil	Filling capacity with oil filter Liters	7.5	
		Filling capacity without oil filter Liters	7.0	
	Specifications for Operating Fluids	Sheet	BB00.40-P-0229-01A	-
		Sheet	BB00.40-P-0229-03A	-
		Sheet	BB00.40-P-0229-05A	BB00.40-P-0229-05A

 Engine lubrication

Number	Designation	Engine 113.967 (shortened maintenance interval)	Engine 113.967 (maximum maintenance interval)	Engine 113.987/988/990/992/993/995	
BF18.00-P-1001-01H	Engine oil	Filling capacity with oil filter Liters	7.5	8.5	
		Filling capacity without oil filter Liters	-	8.0	
	Specifications for Operating Fluids	Sheet	BB00.40-P-0229-01A	-	-
		Sheet	BB00.40-P-0229-03A	-	-

	Sheet	BB00.40-P-0229-05A	BB00.40-P-0229-05A	BB00.40-P-0229-05A
--	-------	--------------------	--------------------	--------------------