

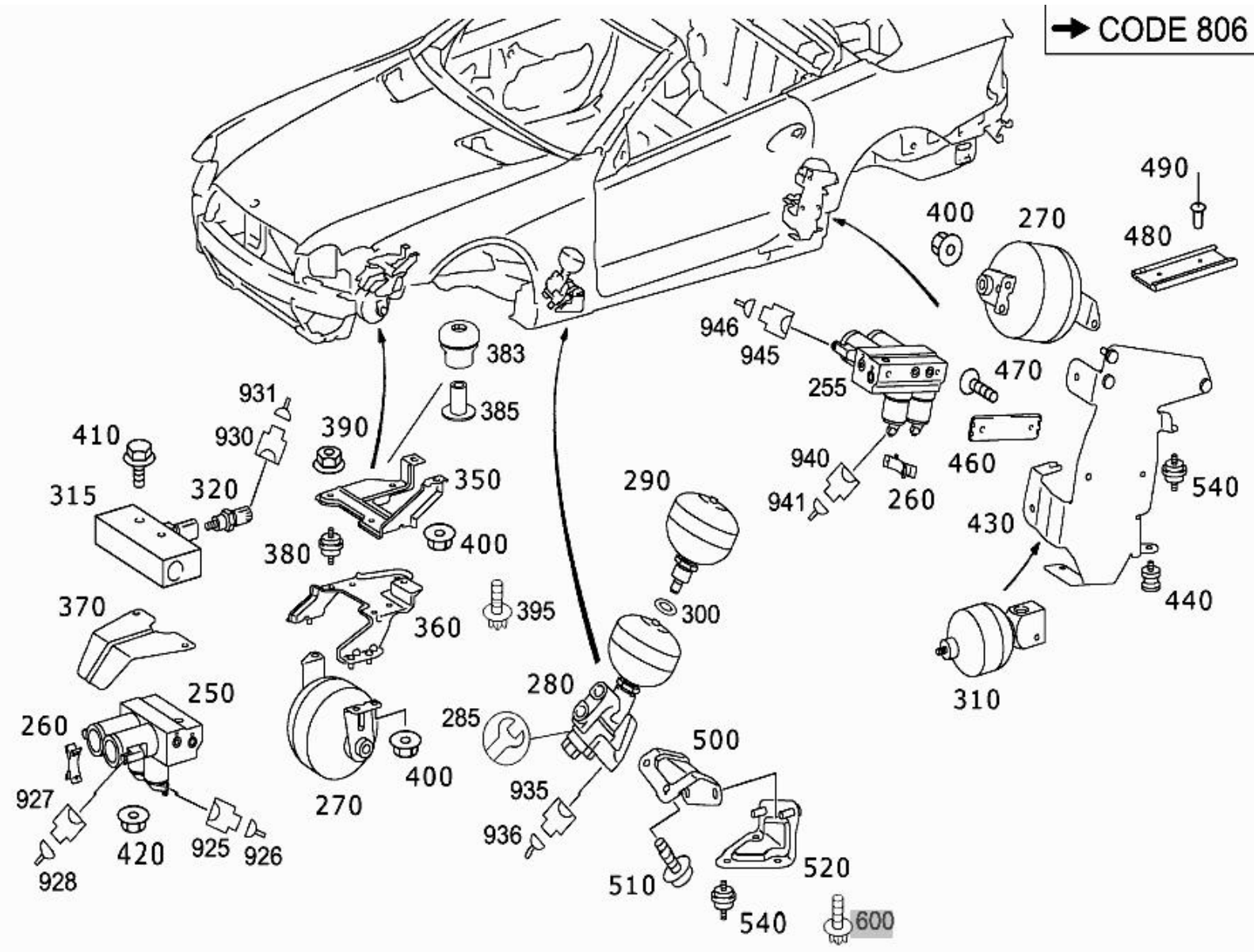



Mode	MD mode	Mod. des. overview	SL ROADSTER
FIN/MD	WDB 2304751F030799	Catalog	65P
VIN	WDBSK75F03F030799	Major assembly	
Sales designation	SL 500	Major assembly MD	
Assortment class	Car	Group	32 - SPRINGS, SUSPENSION AND HYDRAULIC SYSTEM
Market	North America	Subgroup	235 - OIL TANK
VALVES USED FOR "ABC" HYDRAULIC SYSTEM		Picture number	B32235000008.081017



- Parts list -











Mode	MD mode	Mod. des. overview	SL ROADSTER
FIN/MD	WDB 2304751F030799	Catalog	65P
VIN	WDBSK75F03F030799	Major assembly	
Sales designation	SL 500	Major assembly MD	
Assortment class	Car	Group	32 - SPRINGS, SUSPENSION AND HYDRAULIC SYSTEM
Market	North America	Subgroup	235 - OIL TANK

VALVES USED FOR "ABC" HYDRAULIC SYSTEM

Item no.	Part number	Designation/description	Quantity	Version
10	A 230 320 00 14	DASHPOT OIL RESERVOIR Code: 487	001	
20	A 220 993 04 01	. SPRING BELOW OIL FILTER Code: 487	001	
30	A 123 327 01 60	. SEAL RING BETWEEN PUSH SPRING AND FILTER Code: 487	001	
40	A 003 184 61 01	. OIL FILTER IN OIL RESERVOIR Code: 487	001	
50	A 210 997 35 81	. GROMMET ON OIL FILTER Code: 487	001	
60	A 210 327 00 60	. SEAL RING BELOW COVER Code: 487	001	
70	A 210 327 00 21	. COVER OIL RESERVOIR Code: 487	001	
80	A 210 327 00 72	. NUT OIL RESERVOIR Code: 487	001	
90	A 220 320 02 59	. OIL DIPSTICK IN OIL RESERVOIR Code: 487	001	
100	A 123 327 00 59	. . PROTECTIVE CAP OIL DIPSTICK UPPER PART Code: 487	001	
110	A 230 327 06 40	BRACKET OIL RESERVOIR TO WHEELHOUSE	001	
120	N 913023 006001	NUT BRACKET TO WHEELHOUSE M6 Code: 487  [012] To Chassis: F 137238 To Date: 31/05/2007	001	
120	N 913023 006001	NUT OIL TANK TO BRACKET M6 Code: 487  [012] To Chassis: F 137238 To Date: 31/05/2007	001	
120	N 913023 006001	NUT SCREENING TO SIDE MEMBER M6 Code: 487  [012] To Chassis: F 137238 To Date: 31/05/2007	002	
130	A 129 997 16 81	GROMMET OIL RESERVOIR TO WHEELHOUSE Code: 487	001	
140	N 000000 003648	HEXALOBULAR BOLT OIL TANK TO BRACKET M6X25 Code: 487	001	
160	A 230 327 01 86	PROTECTIVE PLATE AT OIL TANK Replaced by: A 230 320 01 86 +002 A 000 990 12 10 Code: 487	001	

160	A 230 320 01 86	SCREENING AT OIL TANK Code: 487	001
170	A 201 504 01 12	RUBBER MOUNT OIL RESERVOIR TO COVERING Code: 487	003
180	A 230 997 22 82	SUCTION HOSE FROM OIL TANK TO PUMP	001
190	A 000 995 30 05	CLAMP TO RESERVOIR AND PUMP 26 MM Code: 487	001
250	A 220 320 03 58	VALVE FRONT LEFT Replaced by: A 220 320 12 58 +001 A 230 327 02 86 Code: 487 [004] To Chassis: F 122820 To Date: 30/03/2006 Excep...	001
250	A 220 320 12 58	VALVE FRONT LEFT Code: 487 [004] To Chassis: F 122820 To Date: 30/03/2006 Excep...	001
255	A 220 320 03 58	VALVE REAR LEFT Replaced by: A 220 320 12 58 +001 A 230 320 98 53 +001 A 230 320 99 53 +001 A 230 320 16 54 Code: 487 [004] To Chassis: F 122820 To Date: 30/03/2006 Excep...	001
255	A 220 320 12 58	VALVE REAR LEFT Code: 487 [004] To Chassis: F 122820 To Date: 30/03/2006 Excep...	001
260	A 010 988 37 78	. CLIP Code: 487 [004] To Chassis: F 122820 To Date: 30/03/2006 Excep...	004
270	A 220 327 01 15	AIR RESERVOIR PRESSURE RESERVOIR FRONT AXLE AND REAR AXLE Code: 487 [004] To Chassis: F 122820 To Date: 30/03/2006 Excep...	002
280	A 220 320 08 58	VALVE UNIT Code: 487 [004] To Chassis: F 122820 To Date: 30/03/2006 Excep... Note: 040909	001
285	A 220 320 11 58	. REPAIR KIT PRESSURE SENSOR ABC Code: 487 [004] To Chassis: F 122820 To Date: 30/03/2006 Excep...	001
290	A 220 327 02 15	. PRESSURE ACCUMULATOR Code: 487 [004] To Chassis: F 122820 To Date: 30/03/2006 Excep...	001
300	A 028 997 33 48	. . SEAL RING AT AIR RESERVOIR Code: 487 [004] To Chassis: F 122820 To Date: 30/03/2006 Excep...	001
310	A 220 320 04 15	AIR CELL RETURN RESERVOIR Code: 487 [004] To Chassis: F 122820 To Date: 30/03/2006 Excep...	001
315	A 220 320 00 51	DISTRIBUTOR DISTRIBUTOR WITH TEMPERATURE SENSOR IN RETURN REAR Code: 487 [014] To Chassis: F 062919 To Date: 31/08/2003	001

320	A 005 153 63 28	. TEMPERATURE SENSOR IN FRONT RETURN Code: 487  [016] To Chassis: F 062919 To Date: 29/08/2003	001
350	A 230 320 09 43	BRACKET FRONT VALVE UNIT Code: 487  [004] To Chassis: F 122820 To Date: 30/03/2006 Excep...	001
360	A 230 320 01 35	PLATE PRESSURE ACCUMULATOR TO BRACKET Code: 487  [004] To Chassis: F 122820 To Date: 30/03/2006 Excep...	001
370	A 230 327 02 86	PROTECTIVE PLATE TO TOP VALVE UNIT Code: 487  [004] To Chassis: F 122820 To Date: 30/03/2006 Excep...	001
380	A 117 988 00 11	BUFFER MOUNTING PLATE TO BRACKET Code: 487  [004] To Chassis: F 122820 To Date: 30/03/2006 Excep...	002
383	A 230 988 00 11	BUFFER MOUNTING PLATE TO BRACKET Code: 487  [004] To Chassis: F 122820 To Date: 30/03/2006 Excep...	001
385	A 230 981 00 53	SLEEVE MOUNTING PLATE TO BRACKET Code: 487  [004] To Chassis: F 122820 To Date: 30/03/2006 Excep...	001
390	N 913012 006001	NUT MOUNTING PLATE TO BRACKET M6 Code: 487  [004] To Chassis: F 122820 To Date: 30/03/2006 Excep...	005
390	N 913012 006001	NUT RUBBER BUFFER TO BRACKET M6 Code: 487	004
390	N 913012 006001	NUT ATTACHMENT PLATE M6 Code: 487  [004] To Chassis: F 122820 To Date: 30/03/2006 Excep...	003
395	N 910143 006005	HEXALOBULAR BOLT MOUNTING PLATE TO BRACKET M6X35 Code: 487  [004] To Chassis: F 122820 To Date: 30/03/2006 Excep...	001
400	N 913023 006001	NUT PRESSURE ACCUMULATOR TO BRACKET M6 Code: 487  [004] To Chassis: F 122820 To Date: 30/03/2006 Excep...	003
400	N 913023 006001	NUT DISTRIBUTOR TO MOUNTING PLATE M6 Code: 487  [004] To Chassis: F 122820 To Date: 30/03/2006 Excep...	001
400	N 913023 006001	NUT PRESSURE ACCUMULATOR TO BRACKET M6 Code: 487  [012] To Chassis: F 137238 To Date: 31/05/2007	003
400	N 913023 006001	NUT RETURN RESERVOIR TO BRACKET M6 Code: 487  [004] To Chassis: F 122820 To Date: 30/03/2006 Excep...	001
400	N 913023 006001	NUT ATTACHMENT PLATE M6 Code: 487  [004] To Chassis: F 122820 To Date: 30/03/2006 Excep...	002

410	N 000000 004310	HEXAGON HEAD BOLT VALVE UNIT TO MOUNTING PLATE M6X10 Code: 487  [004] To Chassis: F 122820 To Date: 30/03/2006 Excep...	002
410	N 000000 004310	HEXAGON HEAD BOLT DISTRIBUTOR TO MOUNTING PLATE M6X10 Code: 487  [004] To Chassis: F 122820 To Date: 30/03/2006 Excep...	001
410	N 000000 004310	HEXAGON HEAD BOLT VALVE UNIT TO BRACKET M6X10 Code: 487	002
410	N 000000 004310	HEXAGON HEAD BOLT RETURN RESERVOIR TO BRACKET M6X10 Code: 487  [004] To Chassis: F 122820 To Date: 30/03/2006 Excep...	001
420	N 913023 008003	NUT BRACKET TO BOTTOM CONNECTION Code: 487  [004] To Chassis: F 122820 To Date: 30/03/2006 Excep...	001
420	N 913023 008003	NUT BRACKET TO SIDE MEMBER Code: 487  [004] To Chassis: F 122820 To Date: 30/03/2006 Excep...	001
430	A 230 320 04 43	BRACKET REAR VALVE UNIT Code: 487  [004] To Chassis: F 122820 To Date: 30/03/2006 Excep...	001
440	A 116 988 09 11	BUFFER AT BRACKET Code: 487	002
460	A 230 328 01 35	PLATE AT BRACKET Code: 487	001
470	N 000000 004447	SCREW MOUNTING PLATE TO BRACKET Code: 487	002
480	A 230 993 00 25	SPRING BRACKET IN SHELL RECESS Code: 487	001
490	A 003 990 34 97	BLIND RIVET SPRING CLIP MOUNTING 4X8	004
500	A 230 327 05 40	BRACKET TO COMPACT UNIT Code: 487  [004] To Chassis: F 122820 To Date: 30/03/2006 Excep...	001
510	N 910143 006000	HEXALOBULAR BOLT BRACKET TO COMPACT UNIT M6X12 Code: 487  [004] To Chassis: F 122820 To Date: 30/03/2006 Excep...	002
520	A 230 320 03 35	PLATE AT SIDE MEMBER Code: 487  [004] To Chassis: F 122820 To Date: 30/03/2006 Excep...	001
540	A 102 988 01 11	BUFFER AT BRACKET Code: 487	001
540	A 102 988 01 11	BUFFER AT SIDE MEMBER Code: 487  [004] To Chassis: F 122820 To Date: 30/03/2006 Excep...	003
630	A 000 905 09 01	. PRESSURE SENSOR FRONT AXLE Code: 487	003
690	N 000000 003175	NUT BRACKET MOUNTING M8 Code: 487	002

750	N 000000 003175	NUT BRACKET MOUNTING M8 Code: 487	002
770	A 000 905 09 01	. PRESSURE SENSOR REAR AXLE Code: 487	002
925	A 168 540 01 81	SOCKET HOUSING VALVE UNIT LEVEL CONTROL CONTROL VALVE, LEFT 2 PIN MQS;Y36/B4 ☐ [004] To Chassis: F 122820 To Date: 30/03/2006 Excep...	001
925	A 168 540 01 81	SOCKET HOUSING VALVE UNIT LEVEL CONTROL CONTROL VALVE, RIGHT 2 PIN MQS;Y36/B3 ☐ [004] To Chassis: F 122820 To Date: 30/03/2006 Excep...	001
926	A 000 540 23 05	REP.SET CONTACT 0.5 MM2 MQS ☐ [004, 011] To Chassis: F 122820 To Date: 30/03/2006 ...	NB
927	A 210 540 20 81	PIN BUSHING HOUSING VALVE UNIT LEVEL CONTROL SHUTOFF VALVE, LEFT 2-PIN MQS;Y36/A2 ☐ [004] To Chassis: F 122820 To Date: 30/03/2006 Excep...	001
927	A 210 540 20 81	PIN BUSHING HOUSING VALVE UNIT LEVEL CONTROL SHUTOFF VALVE, RIGHT 2-PIN MQS;Y36/A1 ☐ [004] To Chassis: F 122820 To Date: 30/03/2006 Excep...	001
928	A 000 540 23 05	REP.SET CONTACT 0.5 MM2 MQS ☐ [004, 011] To Chassis: F 122820 To Date: 30/03/2006 ...	NB
930	A 210 540 20 81	PIN BUSHING HOUSING OIL TEMPERATURE SENSOR ABC 2-PIN MQS;B40/1 ☐ [004] To Chassis: F 122820 To Date: 30/03/2006 Excep...	001
931	A 000 540 23 05	REP.SET CONTACT 0.5 MM2 MQS ☐ [004, 011] To Chassis: F 122820 To Date: 30/03/2006 ...	NB
935	A 220 540 06 81	PIN BUSHING HOUSING PRESSURE SENSOR ABC 3-PIN MQS;B4/5 ☐ [004] To Chassis: F 122820 To Date: 30/03/2006 Excep...	001
936	A 000 540 23 05	REP.SET CONTACT 0.5 MM2 MQS ☐ [004, 011] To Chassis: F 122820 To Date: 30/03/2006 ...	NB
940	A 210 540 20 81	PIN BUSHING HOUSING VALVE UNIT LEVEL CONTROL SHUTOFF VALVE, LEFT 2-PIN MQS;Y36/A7 ☐ [004] To Chassis: F 122820 To Date: 30/03/2006 Excep...	001
940	A 210 540 20 81	PIN BUSHING HOUSING VALVE UNIT LEVEL CONTROL SHUTOFF VALVE, RIGHT 2-PIN MQS;Y36/A8 ☐ [004] To Chassis: F 122820 To Date: 30/03/2006 Excep...	001
941	A 000 540 23 05	REP.SET CONTACT 0.5 MM2 MQS ☐ [004, 011] To Chassis: F 122820 To Date: 30/03/2006 ...	NB
945	A 168 540 01 81	SOCKET HOUSING VALVE UNIT LEVEL CONTROL CONTROL VALVE, LEFT 2 PIN MQS;Y36/B9 ☐ [004] To Chassis: F 122820 To Date: 30/03/2006 Excep...	001
945	A 168 540 01 81	SOCKET HOUSING VALVE UNIT LEVEL CONTROL CONTROL VALVE, RIGHT 2 PIN MQS;Y36/B10 ☐ [004] To Chassis: F 122820 To Date: 30/03/2006 Excep...	001
946	A 000 540 23 05	REP.SET CONTACT 0.5 MM2 MQS ☐ [004, 011] To Chassis: F 122820 To Date: 30/03/2006 ...	NB