

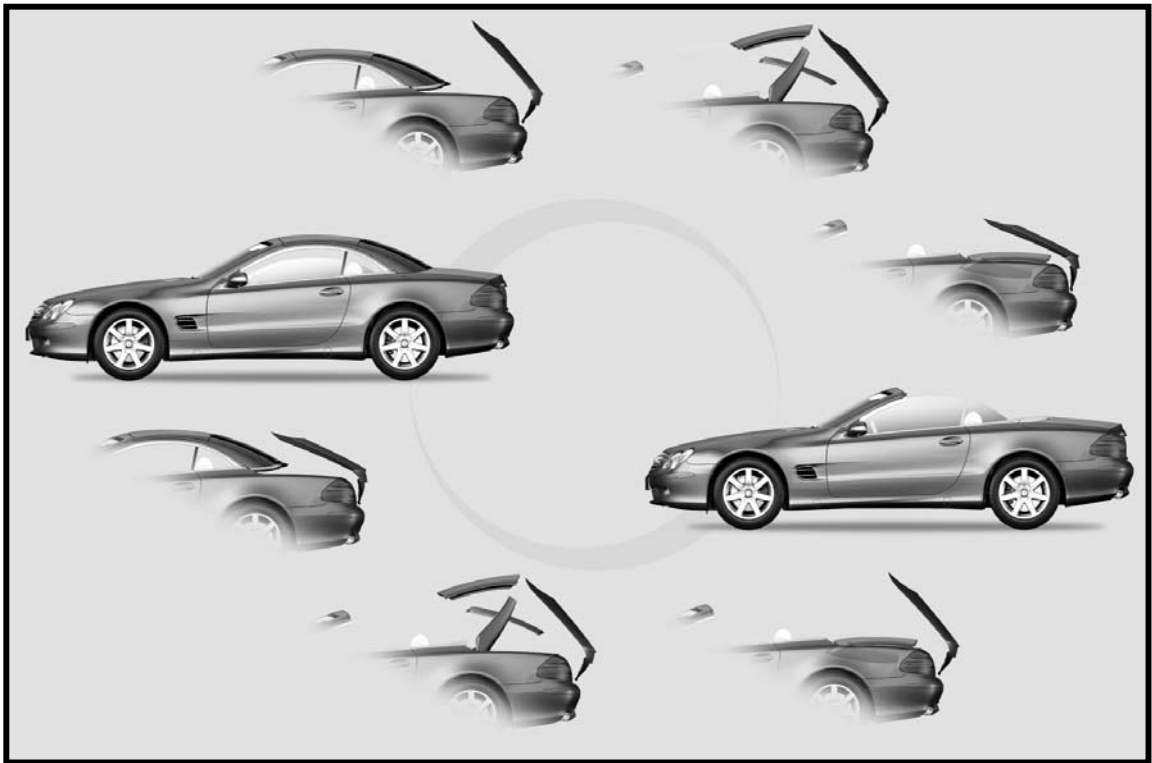

Mercedes-Benz

R230

Vario Roof Diagnostic Aid



These technical training materials are designed to be used in a supervised training course and consists of information that is organized in sequence with the instructor's presentation. They are not intended as a self-study course. Operational information is covered in detail. However, testing, diagnosis and location of components are not included. You must depend on the technical library for this additional information. These technical training materials are current as of the date noted on the materials and may be revised or updated without notice. Please always check for revised or updated information. To help avoid personal injury to you or others and to avoid damage to the vehicle on which you are working, you must always refer to the latest Mercedes-Benz Technical Publication and follow all pertinent instructions when testing, diagnosing or making repair.

*Copyright Mercedes-Benz USA, LLC
2001*

Reproduction by any means or by any information storage and retrieval system or translation in whole or part is not permitted without written authorization from Mercedes-Benz USA, LLC or its successors.

Published by Mercedes-Benz USA, LLC

Printed in U.S.A.

Diagnostic Contents

1. Hydraulic Cylinder Layout
2. Microswitch Layout
3. Simplified Wiring Diagram
4. Top Sequence Descriptions (Open & Close)
5. Microswitch DTC Codes
6. Diagnostic Scenarios
 - S69/1
 - S69/2 & S69/3
 - S69/11
 - S117 (pin 29)
 - S117 (pin 41)
 - S118/1 & S118/2
 - S119
 - S126/1 & S127/1

Note: This Vario roof will usually reverse direction unless noted in the scenario.

In the scenarios: INOP = Top will not function at all - will not start sequence.

STUCK = Top will stop mid-cycle - will not reverse either.

7. Component Locations

Basic Hydraulic Cylinder Layout

- Total of 8 hydraulic cylinders involved for roof operation -

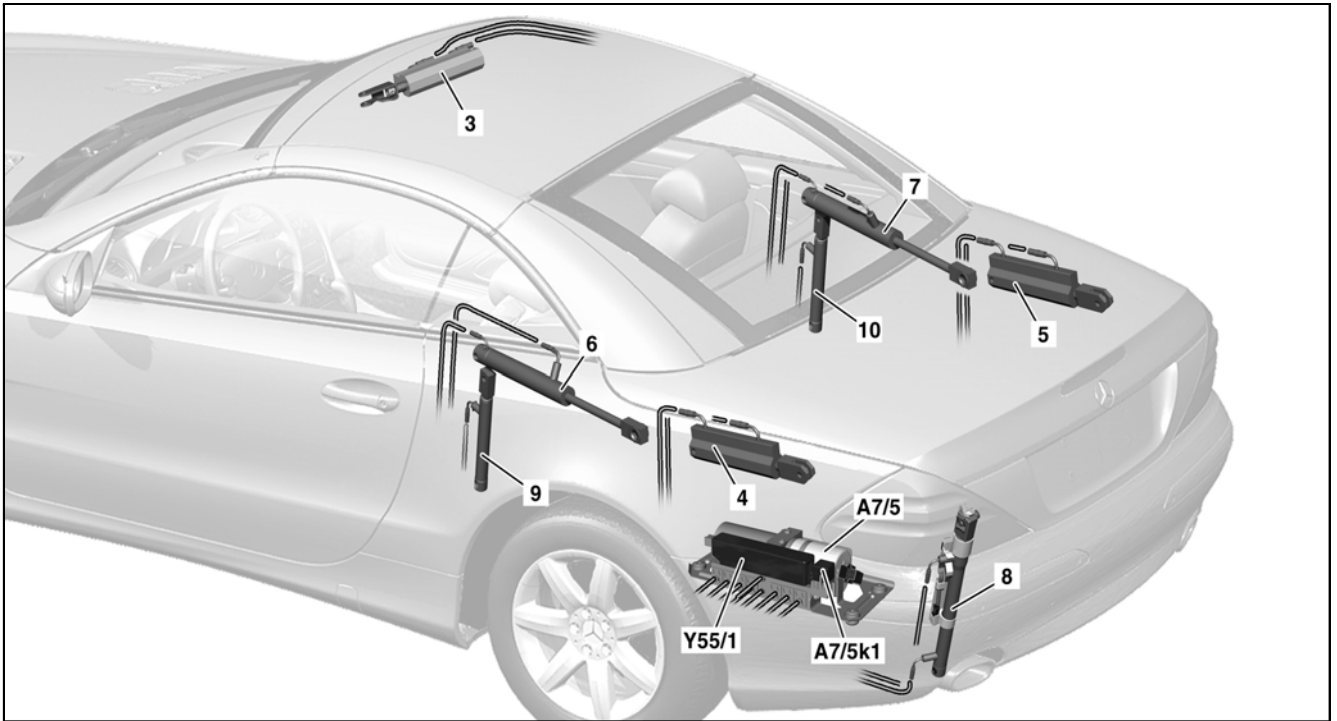

Cylinder Designation	Name of Cylinder
3	Front vario roof lock hydraulic cylinder
4	Left tubular frame lock hydraulic cylinder
5	Right tubular frame lock hydraulic cylinder
6	Left vario roof (open/close) hydraulic cylinder
7	Right vario roof (open/close) hydraulic cylinder
8	Trunk lid hydraulic cylinder
9	Left load assist (raise/lower) hydraulic cylinder
10	Right load assist (raise/lower) hydraulic cylinder
A7/5	RVC hydraulic unit
A7/5k1	Relay
Y55/1	RVC valve block

Basic Microswitch Layout

- Total of 13 switches involved for roof operation -

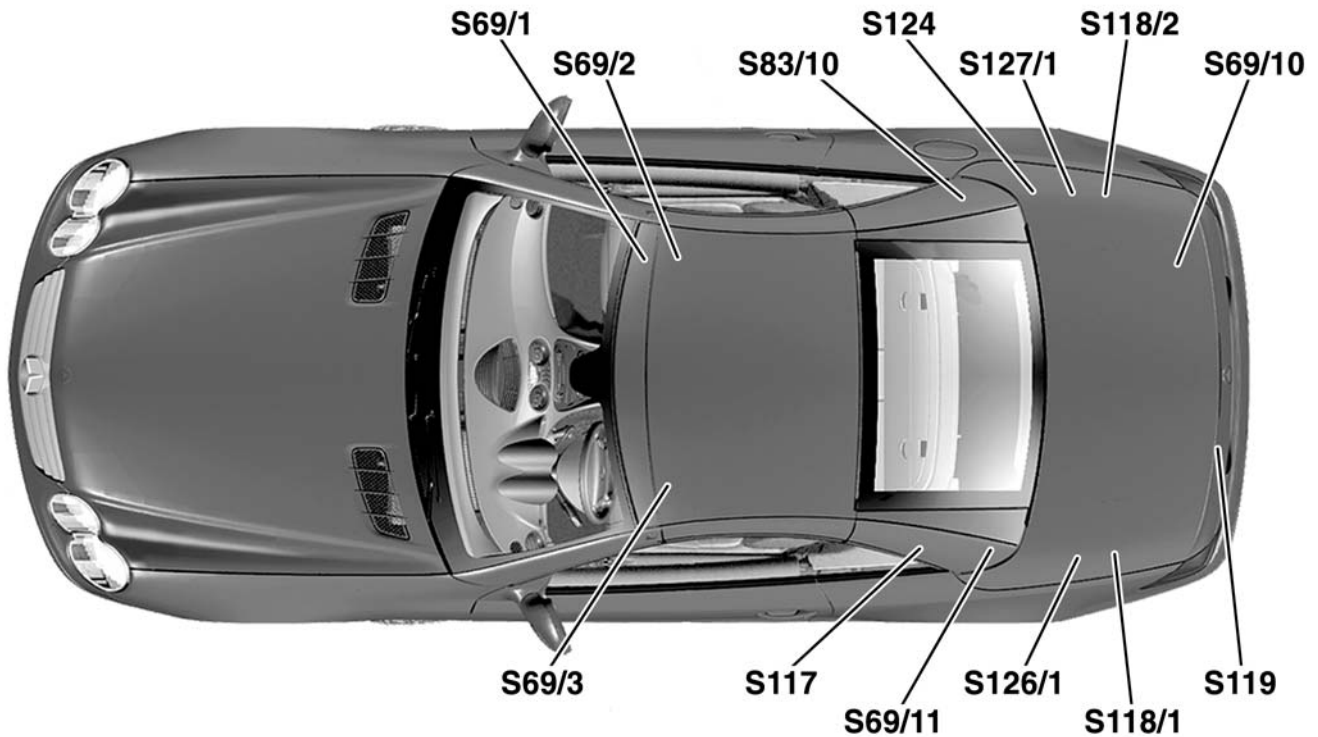





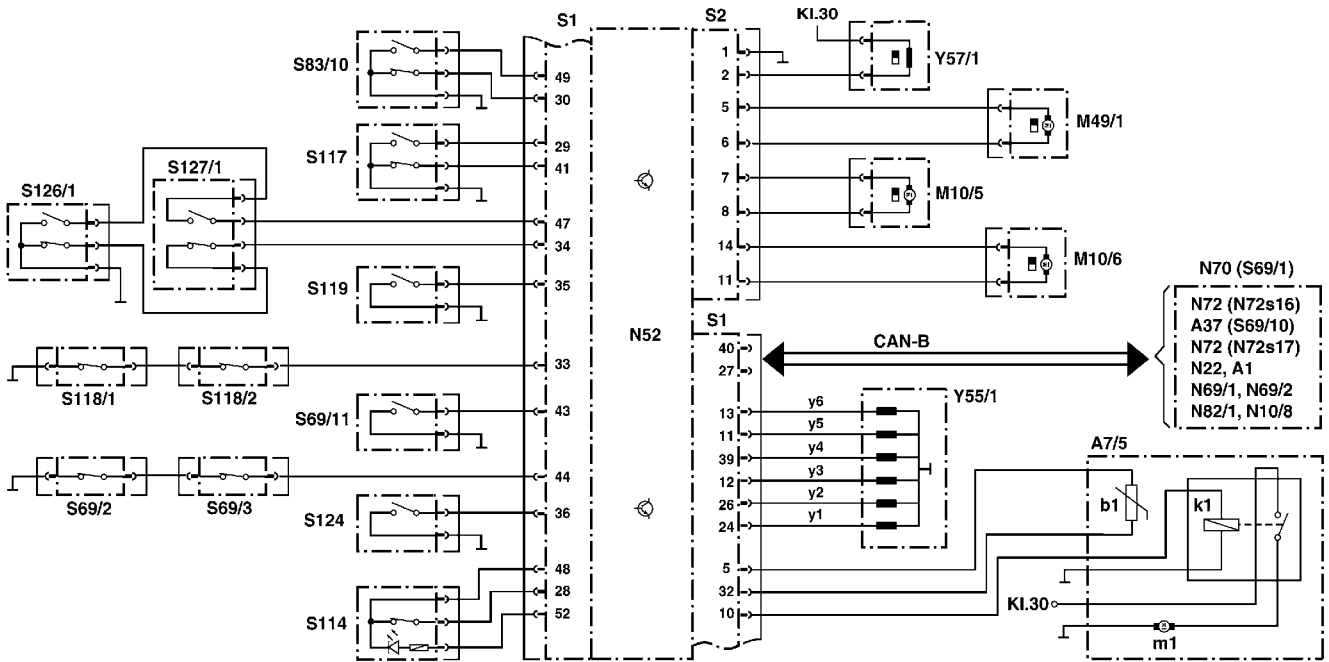

Switch Designation	Name of Switch
S69/1	Vario roof limit switch
S69/2	Vario roof locked limit switch
S69/3	Vario roof locked limit switch
S69/10	Luggage compartment partition limit switch
S69/11	Vario roof raised / lowered limit switch
S83/10	Rollover bar raised / lowered limit switch
S117	Load assist limit switch
S118/1	Left tubular frame locked limit switch
S118/2	Right tubular frame locked limit switch
S119	Tubular frame raised limit switch
S124	Trunk lid open limit switch
S126/1	Left side flap closed / open limit switch
S127/1	Right side flap closed / open limit switch

Simplified Wiring Diagram







- S69/1 Vario roof limit switch (right locking pin)
- S69/2 Vario roof locked limit switch (right)
- S69/3 Vario roof locked limit switch (left)
- S69/10 Luggage compartment partition limit switch
- S69/11 Vario roof raised / lowered limit switch
- S83/10 Rollover bar raised / lowered limit switch
- S114 Load assist (Easy Pack) switch
- S117 Load assist top / bottom limit switch
- S118/1 Left tubular frame locked limit switch
- S118/2 Right tubular frame locked limit switch
- S119 Tubular frame open limit switch
- S124 Trunk lid open limit switch
- S126/1 Left side flap closed / open limit switch (elephant ears)
- S127/1 Right side flap closed / open limit switch (elephant ears)

Opening Sequence of Roof

<p>Stage 0</p> 	<p>Vario roof activated. Pump builds pressure, (y1) energizes, then (y3) and (y4) energize, forcing roof forward to ease tension on locks.</p>
<p>Stage 1</p> 	<p>Next (y5) energizes, causing cylinder 3 to unlock the front Vario roof locks. Switches S69/2 & /3 confirm it's not locked. Next, cylinders 4 & 5 unlock the tubular frame. Switches S118/1 & S118/2 confirm it's not locked. Front windows move to short stroke position, rear windows open completely. Cylinder 8 causes trunk lid to move to the raised position. Switch S119 confirms trunk lid is raised.</p>
<p>Stage 2</p> 	<p>Side flaps are folded out. Switches S126/1 and S127/1 confirm both side flaps folded out completely.</p>
<p>Stage 3</p> 	<p>Solenoid (y3) de-energizes causing cylinders 6 and 7 move the Vario roof to the open position - while (y4) is still energized supplying hydraulic pressure to cylinders 6 & 7. Switch S69/1 confirms roof is no longer at the a-pillar, and S69/11 confirms the roof has completely opened.</p>
<p>Stage 4</p> 	<p>Solenoid (y6) is energized causing cylinders 9 and 10 to depressurize allowing the roof to lower into trunk. Switch S117 confirms the roof is not in "Easy Pack" and also that it has completely lowered into trunk. This is a dual position switch.</p>
<p>Stage 5</p> 	<p>Solenoid (y4) de-energizes, depressurizing cylinders 6 & 7. Solenoid (y5) de-energizes allowing hydraulic pressure from (y1) to lock cylinder 3 (front Vario roof locks). Trunk lid is closed via cylinder 8, tubular frame is locked via cyl. 4 & 5. S118/1 & /2 confirm tubular frame locks are locked. Door windows close. Solenoids (y1) & (y6) are de-energized, thus depressurizing related cylinders.</p>

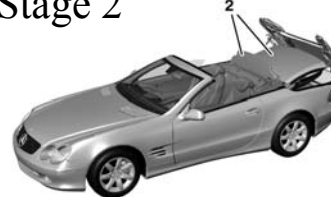
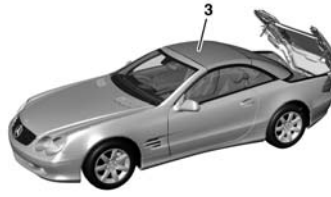
Closing Sequence of Roof

<p>Stage 0</p> 	<p>Vario roof activated. Solenoid (y6) energizes to prevent Vario roof from moving into “Easy Pack”, then the pump builds pressure. Solenoid (y1) energizes, supplying system pressure. Next, solenoid (y5) energizes, causing cylinder 3 (front Vario roof locks) to unlock. Switches S69/2 & /3 confirm it’s not locked. Next, cylinders 4 & 5 unlock the tubular frame locks. Switches S118/1 & /2 confirm it’s not locked.</p>
<p>Stage 1</p> 	<p>Front windows move to short stroke position, rear windows open completely. Cylinder 8 causes trunk lid to move to the raised position. Switch S119 confirms trunk lid is raised.</p>
<p>Stage 2</p> 	<p>Solenoid (y6) is de-energized causing cylinders 9 and 10 to raise the Vario roof into “Easy Pack” position. Switch S117 confirms the roof is not still lowered into trunk and that it has completely moved into “Easy Pack” position. This is a dual position switch.</p>
<p>Stage 3</p> 	<p>Solenoid (y3) energizes causing cylinders 6 and 7 to move the Vario roof to the closed position. Switch S69/11 confirms that the roof has left “Easy Pack” and S69/1 confirms the roof is in a closed position.</p>
<p>Stage 4</p> 	<p>Side flaps are folded in. Switches S126/1 and S127/1 confirm both side flaps folded in completely.</p>
<p>Stage 5</p> 	<p>Solenoid (y5) de-energizes allowing hydraulic pressure from (y1) to lock cylinder 3 (front Vario roof locks). Switches S69/2 & /3 confirm it’s locked. Trunk lid is closed via cylinder 8 and tubular frame is locked via cyl. 4 & 5. S118/1 & /2 confirm tubular frame locks are locked. Solenoids (y1) and (y3) are de-energized, thus depressurizing related cylinders. All Windows close.</p>

Possible DTC Codes

For Microswitches

<u>DTC</u>	<u>Description</u>
------------	--------------------

- | | |
|------------|--|
| •B1194-000 | S118/1, S118/2, S119 - Switching status not possible. |
| •B1195-000 | S126/1, S127/1 - Switching status not possible. |
| •B1196-000 | S117 - Switching status not possible. |
| •B1197-000 | S69/1, S69/11 - Switching status not possible. |
| •B1198-001 | S83/10 - Limit switch 'DOWN' not operating or has cable break. |
| •B1198-002 | S83/10 - Limit switch 'DOWN' remains in the switched status or has short. |
| •B1262-001 | S69/11 - The component does not operate or has cable break. |
| •B1262-002 | S69/11 - The component remains in the switched status or has short. |
| •B1262-017 | S69/1 - The component does not operate or has cable break. |
| •B1262-018 | S69/1 - The component remains in the switched status or has short. |
| •B1263-001 | S69/2, S69/3 - One component does not operate or has cable break. |
| •B1263-002 | S69/2, S69/3 - One component remains in the switched state or has short. |
| •B1264-001 | S117 - Limit switch 'UP' not operating or has cable break. |
| •B1264-002 | S117 - Limit switch 'UP' remains in the switched status or has short. |
| •B1264-017 | S117 - Limit switch 'DOWN' not operating or has cable break. |
| •B1264-018 | S117 - Limit switch 'DOWN' remains in the switched status or has short. |
| •B1265-001 | S126/1, S127/1 - One of the limit switches "FOLDED IN" does not operate. |
| •B1265-002 | S126/1, S127/1 - One of the limit switches "FOLDED IN" remains switched. |
| •B1265-017 | S126/1, S127/1 - One of the limit switches "FOLDED OPEN" does not operate. |
| •B1265-018 | S126/1, S127/1 - One of the limit switches "FOLDED OPEN" remains switched. |
| •B1266-001 | S119 - The component does not operate or has cable break. |
| •B1266-002 | S119 - The component remains in the switched status or has short. |
| •B1266-017 | S118/1, S118/2 - One component does not operate or has cable break. |
| •B1266-018 | S118/1, S118/2 - One component remains in the switched state or has short. |

Functions Available with DAS



- Control Unit Version
- Fault Codes
- Actual Values
- Actuation's
- Resetting RVC after actuation's
- Complete list of guided tests & fault code
- Test Steps Hydraulics

Diagnostic Scenarios

For Microswitches

The following pages include:

- Description of each microswitch
- Location with photo
- Microswitch failure with an open circuit
- Microswitch failure with a shorted/sticking switch
- Photos illustrating top sequence interruption points for both types of failures in both sequences

Microswitch - S69/1

Switch Number: **S69/1** signal thru OCP via CAN-B

Description: Vario roof limit switch. This switch will register that the top/front edge of the roof has come in contact with the top of the windshield frame.

Location: Right side of windshield frame

Actual Values: **(373)** - Recognized = switched contact closed
Not Recognized = switched contact open

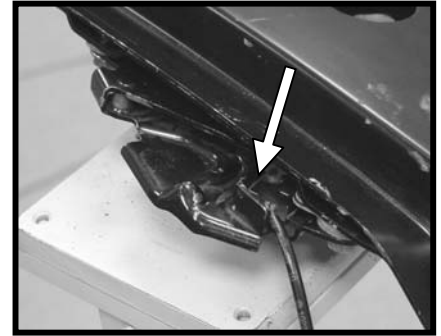

S69/1 - Shorted / Sticking



Top sequence: Opening
Top operation not affected.
Will completely open.



Top sequence: Closing
Top will not operate - INOP

S69/1 - Open



Top sequence: Opening
Top will not operate - INOP.



Top sequence: Closing
Top operates until pictured.
Pump continues to run.

Microswitch - S69/2 & S69/3

Switch Number: **S69/2 & S69/3** wired to RVC.(pin44-pr/org)

Description: Vario roof locked limit switch (right and left).
This switch will register if the roof has locked itself to the a-pillar. Both switches feed a ground signal back. (*wired in series*)

Location: On the locks for Vario roof front edge

Actual Values: **(374)** - Recognized = switched contact closed
Not Recognized = switched contact open



S69/2 & S69/3 - Shorted / Sticking



Top sequence: Opening

Top operates until pictured. Pump continues to run. (note FLAPS)



Top sequence: Closing

Top operates until pictured. Pump continues to run. (note FLAPS)

S69/2 & S69/3 - Open



Top sequence: Opening

Top operates fully except pump continues to run and warning tone & message "hardtop open" displayed.



Top sequence: Closing

Top operates fully except pump continues to run - warning tone rings and windows never fully close - 1/4 inch gap remains.

Microswitch - S69/11

Switch Number: **S69/11** wired to RVC. (pin 43-purple)

Description: Vario roof raised / lowered.

This switch will register that the Vario roof is lowered, but not stowed yet. When this switch is closed, the roof is also in Easy Pack.

Location: On the drivers side, rear of main pivot

Actual Values: **(372)** - Recognized = switched contact closed
Not Recognized = switched contact open

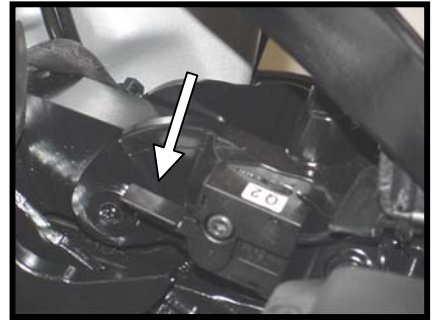

S69/11 - Shorted / Sticking



Top sequence: Opening
Top will not function - INOP.



Top sequence: Closing
Top operation not affected.
Will completely close.

S69/11 - Open



Top sequence: Opening
Top operates until pictured. Stops prior to dropping easy pack. Pump continues to run.



Top sequence: Closing
Top will not function - INOP.

Microswitch - S117

Switch Number: **S117** wired to RVC. (pin 29 - wht/gry)

Description: Load assist down. This switch will register that the Vario roof is completely stowed in the trunk. This one unit contains two microswitches - this page and next page.

Location: Drivers side, main pivot for roof

Actual Values: **(376)** - Recognized = switched contact closed
Not Recognized = switched contact open

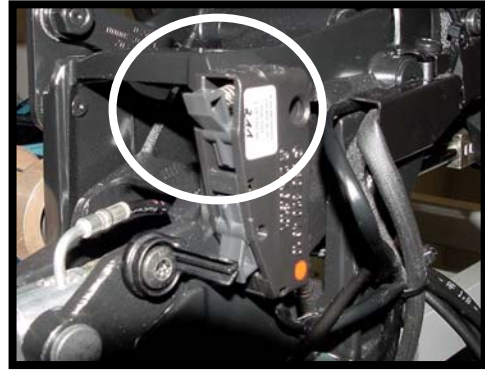

S117 (pin 29) - Shorted / Sticking



Top sequence: Opening
Top will not function - INOP.



Top sequence: Closing
Top operation not affected.
Will completely close.

S117 (pin 29) - Open



Top sequence: Opening
Top operates until pictured. Pump continues to run.



Top sequence: Closing
Top will not function - INOP.

Microswitch - S117

Switch Number: **S117** wired to RVC. (pin 41 - wht)

Description: Load assist up. This switch will register that the Vario roof is raised into the easy pack position. This one unit contains two microswitches - this page and previous page.

Location: Drivers side, main pivot for roof

Actual Values: **(375)** - Recognized = switched contact closed
Not Recognized = switched contact open

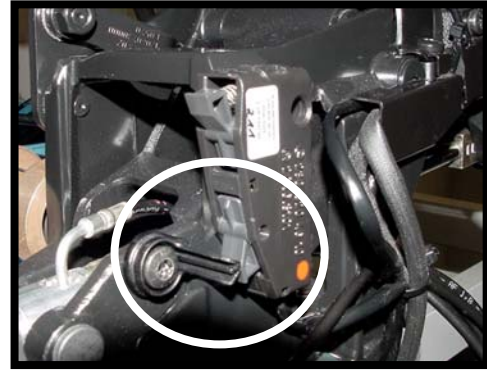

S117 (pin 41) - Shorted / Sticking



Top sequence: Opening
Top operation not affected.
Will completely open.



Top sequence: Closing
Top will not function - INOP.

S117 (pin 41) - Open



Top sequence: Opening
Top operates until pictured. Pump continues to run and front windows drop down 1/4 inch.



Top sequence: Closing
Top operates until pictured. Pump continues to run.

Microswitch - S118/1 & S118/2

Switch Number: **S118/1/2** wired to RVC. (pin33 - wht/yel)

Description: Tubular frame locked switch (right and left).
This switch will register that the trunk lid has locked itself completely. Both switches feed a ground signal back. (*wired in series*)

Location: On the locks for the tubular frame (in trunk)

Actual Values: **(380)** - Recognized = switched contact closed
Not Recognized = switched contact open



S118/1 & S118/2 - Shorted / Sticking



Top sequence: Opening
Top operates until pictured. Pump stops, will not reverse - STUCK.



Top sequence: Closing
Top operates until pictured. Pump stops, will not reverse - STUCK.

S118/1 & S118/2 - Open



Top sequence: Opening
Top operates fully except pump continues to run - warning tone rings and windows never fully close - 1/4 inch gap remains.



Top sequence: Closing
Top operates fully except pump continues to run - warning tone rings and windows never fully close - 1/4 inch gap remains.

Microswitch - S119

Switch Number: **S119** wired to RVC. (pin 35 - wht/org)

Description: Tubular frame full open switch. This switch will register if the tubular frame has fully opened. This switch passes through connector X111 then to control unit.

Location: On the hydraulic cylinder #8

Actual Values: **(379)** - Recognized = switched contact closed
Not Recognized = switched contact open

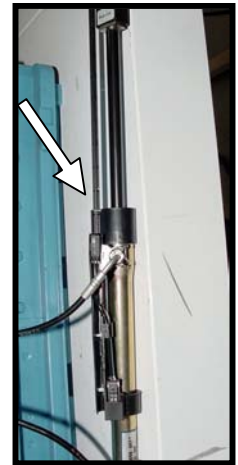

S119 - Shorted / Sticking



Top sequence: Opening
Top will not function - INOP.



Top sequence: Closing
Top will not function - INOP.

S119 - Open



Top sequence: Opening
Top operates until pictured. Pump continues to run.



Top sequence: Closing
Top operates until pictured. Pump continues to run.

Microswitch - S126/1 & S127/1

Switch Number: **S126/1 & S127/1** to RVC.(pin34-wht/blk)

Description: Side flaps closed (right and left).**FOLDED IN**
This switch will register if the side flaps have completely closed. Both switches feed a ground signal back. (*wired in series*)

Location: Next to side flap pivot point (either side)

Actual Values: **(377)** - Recognized = switched contact closed
Not Recognized = switched contact open

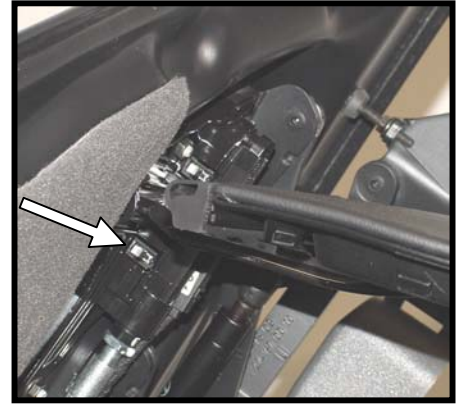

S126/1 & S127/1(pin 34) - Shorted / Sticking



Top sequence: Opening
Top will not function - INOP.



Top sequence: Closing
Top operates until pictured.
Will not reverse. - STUCK

S126/1 & S127/1 (pin 34) - Open



Top sequence: Opening
Top will not function - INOP.



Top sequence: Closing
Top operates until pictured. Pump runs for about 10 seconds longer, then stops.

Microswitch - S126/1 & S127/1

Switch Number: **S126/1 & S127/1** to RVC.(pin47-wht/viot)

Description: Side flaps open(right and left).**FOLDED OPEN**
This switch will register if the side flaps have completely opened. Both switches feed a ground signal back. (*wired in series*)

Location: Next to side flap pivot point (either side)

Actual Values: **(378)** - Recognized = switched contact closed
Not Recognized = switched contact open



S126/1 & S127/1(pin 47) - Shorted / Sticking



Top sequence: Opening
Top will not function - INOP.



Top sequence: Closing
Top operation not affected.
Will completely close.

S126/1 & S127/1 (pin 47) - Open



Top sequence: Opening
Top operates until pictured. **STUCK**
and will not reverse.



Top sequence: Closing
Top will not function - INOP.

Other Component Locations

- N52 - Vario roof (VR) control unit
 - Under right side storage shelf under rear Sam control unit.

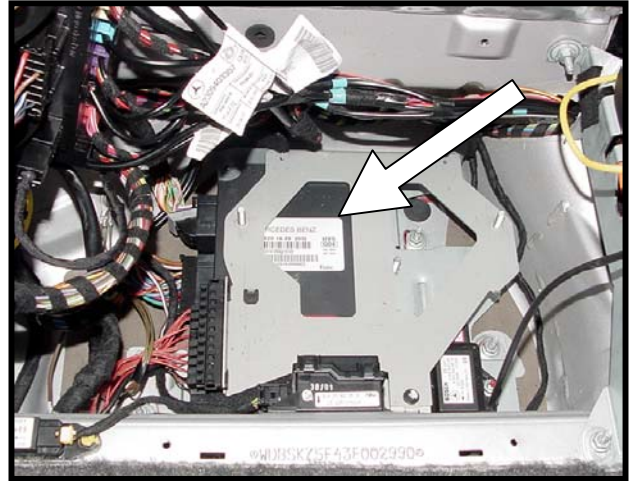

- A7/5 - VR hydraulic unit
 - Left side, bottom of trunk.



- Y55/1 - Vario roof hydraulic valve block
 - On pump assembly.
- A7/5k1 - Pump Relay
- “a” - Pressure release for valve Y6
 - This will lower Easy Pack, so be careful when opening)
 - Failure to close will not damage pump, but no pressure will build.

