

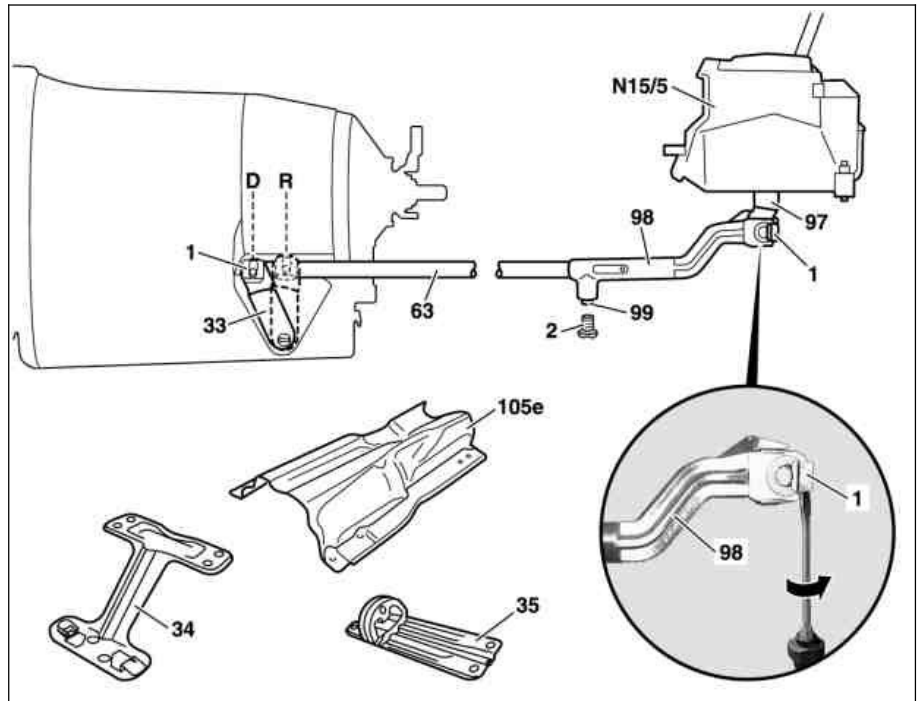





TRANSMISSION 722.6 /9 in MODEL 230

- 1 Locking plate
- 2 Security bolt
- 33 Range selector lever
- 34 Front reinforcement brace
- 35 Cross strut
- 63 Shift rod
- 97 Intermediate lever
- 98 Rod head
- 99 Grub screw
- 105e Heat shield

N15/5 Electronic selector lever module control unit



P27.60-2194-06

	Removing		
 Danger!	Risk of death caused by vehicle slipping or toppling off of the lifting platform.	Align vehicle between columns of vehicle lift and position four support plates at vehicle lift support points specified by vehicle manufacturer.	AS00.00-Z-0010-01A
	The vehicle must be horizontal	 Place the vehicle on the lifting platform.	
1	Place selector lever in position "R"		
2	Remove engine compartment paneling under transmission	Vehicles without code (P99) Special model "AMG Black Series" Vehicles with code (P99) Special model "AMG Black Series"	AR61.20-P-1105R AR61.20-P-1105RBS
3	Remove front stiffening bridge (34) and bracket of engine compartment paneling		
4	Remove cross strut (35) together with exhaust rubber mount		
5	Detach heat shield (105e) under the propeller shaft and push to the rear		
6	Pry off locking plate (1) using a screwdriver and detach shift rod (63) at range selector lever (33).		
7	Move selector lever to position "D".		
8	Pry off locking plate (1) using a screwdriver and detach shift rod (63) at intermediate lever (97).		
9	Take out shift rod (63)		
	Checking		
10	Check bushing at range selector lever (33) and at intermediate lever (97) for damage, replace if necessary.		
	Install		
11.1	Saw a slot in the screw head of the safety screw (2) and unscrew the safety screw (2) at the head (98)	Vehicles with safety screw (2)	
11.2	Remove the grub screw (99) on the head (98)	Vehicles with grub screw (99)	
12	Attach shift rod (63) at intermediate lever (97).		
13	Move selector lever and range selector lever (33) to position "R" and engage shift rod (63) on the range selector lever (33)		
14	Install locking plates (1).	 Instal new locking plates (1).	

15	Move selector lever and range selector lever (33) into position "D"		
16.1	Screw in safety screw (2) on head (98)	Vehicles with safety screw (2) <i>i</i> Replace locking bolt (2). <i>i</i> Counterhold at rod head (98) when tightening. Do not move range selector lever (33) from position "D". Nm	*BA27.60-P-1001-04A
16.2	Screw in grub screw (99) on head (98)	Vehicles with grub screw (99) <i>i</i> Replace grub screw (99). <i>i</i> Counterhold at rod head (98) when tightening. Do not move range selector lever (33) from position "D". Nm	*BA27.60-P-1001-04A
17	Perform a function test		
18	Mount heat shield (105e)		
19	Install cross strut (35) together with exhaust rubber mount	Nm	*BA61.10-P-1007-01C
20	Install front stiffening bridge (34) and bracket of engine compartment paneling	Nm Nm	*BA61.10-P-1006-01C *BA61.10-P-1008-01C
21	Install engine compartment paneling under transmission	Model 230 without code (P99) Special model "AMG Black Series" Model 230 with code (P99) Special model "AMG Black Series"	AR61.20-P-1105R AR61.20-P-1105RBS

Nm Tightening torques for shift rod

Number	Designation		Transmission 722.6	Transmission 722.9
BA27.60-P-1001-04A	Bolt in rod head M8x10	Nm	12	12

Nm Frame floor assembly

Number	Designation		Model 230
BA61.10-P-1006-01C	Collar bolt connecting front reinforcement brace to frame floor	Nm	20
BA61.10-P-1007-01C	Bolts connecting cross strut to frame floor	Nm	20
BA61.10-P-1008-01C	Bolt connecting engine compartment paneling bracket to frame floor	Nm	3