



Vehicle History Report™

US \$39.99

2004 MERCEDES-BENZ E55 AMG VIN: WDBUF76JX4A420632 SEDAN 4 DR 5.5L V8 F DOHC 24V GASOLINE REAR WHEEL DRIVE		Accident reported
		Damage reported: minor damage
		3 Previous owners
		47 Service history records
		Personal vehicle
		143,974 Last reported odometer reading



This CARFAX Vehicle History Report is based only on information supplied to CARFAX and available as of 4/23/21 at 9:50:02 PM (CDT). Other information about this vehicle, including problems, may not have been reported to CARFAX. Use this report as one important tool, along with a vehicle inspection and test drive, to make a better decision about your next used car.

Ownership History	Owner 1	Owner 2	Owner 3
The number of owners is estimated			
Year purchased	2004	2016	2018
Type of owner	Personal	Personal	Personal
Estimated length of ownership	12 yrs. 10 mo.	11 months	3 yrs. 3 mo.
Owned in the following states/provinces	Florida	Florida	Florida
Estimated miles driven per year	8,197/yr	---	9,974/yr
Last reported odometer reading	105,763	105,764	143,974

Title History	Owner 1	Owner 2	Owner 3
CARFAX guarantees the information in this section			
Salvage Junk Rebuilt Fire Flood Hail Lemon	Guaranteed No Problem	Guaranteed No Problem	Guaranteed No Problem
Not Actual Mileage Exceeds Mechanical Limits	Guaranteed No Problem	Guaranteed No Problem	Guaranteed No Problem



GUARANTEED - None of these major title problems were reported by a state Department of Motor Vehicles (DMV). If you find that any of these title problems were reported by a DMV and not included in this report, CARFAX will buy this vehicle back.
[Register](#) | [View Terms](#) | [View Certificate](#)

Additional History	Owner 1	Owner 2	Owner 3
Not all accidents / issues are reported to CARFAX			
Total Loss No total loss reported to CARFAX.	No Issues Reported	No Issues Reported	No Issues Reported
Structural Damage CARFAX recommends that you have this vehicle inspected by a collision repair specialist.	No Issues Reported	No Issues Reported	No Issues Reported

Airbag Deployment No airbag deployment reported to CARFAX.	No Issues Reported	No Issues Reported	No Issues Reported
Odometer Check No indication of an odometer rollback.	No Issues Indicated	No Issues Indicated	No Issues Indicated
Accident / Damage Accidents reported: 10/14/2009, 10/26/2011, and 01/22/2021. Damage reported: 10/03/2013, 10/11/2018, and 12/28/2020.	Accident Reported	No New Issues Reported	Accident Reported
Manufacturer Recall Check with an authorized Mercedes-Benz dealer for any open recalls.	No Recalls Reported	No Recalls Reported	No Recalls Reported
Basic Warranty Original warranty estimated to have expired.	Warranty Expired	Warranty Expired	Warranty Expired



Detailed History

Owner 1



























Purchased: 2004















Low mileage! This owner drove less than the industry average of 15,000 miles per year.

Personal Vehicle
8,197 mi/yr

Date	Mileage	Source	Comments
01/07/2003		Mercedes-Benz of Pompano Pompano Beach, FL 954-943-5000 mercedesfla.com 4.3 / 5.0 90 Verified Reviews 227 Customer Favorites	Vehicle serviced - Body electrical wiring repaired
01/22/2003		Mercedes-Benz of Pompano Pompano Beach, FL 954-943-5000 mercedesfla.com 4.3 / 5.0 90 Verified Reviews 227 Customer Favorites	Vehicle serviced
12/30/2003		Mercedes-Benz of Fort Lauderdale Fort Lauderdale, FL 954-949-0623 mercedesfla.com 4.6 / 5.0 221 Verified Reviews 377 Customer Favorites	Vehicle serviced - Leather/vinyl treatment performed - Oil and filter changed
01/02/2004	15	Florida Motor Vehicle Dept.	Vehicle purchase reported - Titled or registered as personal vehicle
01/09/2004		Florida Motor Vehicle Dept. Boca Raton, FL Title #0089600568	Title issued or updated - First owner reported
01/20/2004	2,076	Service Facility	Vehicle serviced
01/20/2004		Mercedes-Benz of Pompano Pompano Beach, FL 954-943-5000 mercedesfla.com 4.3 / 5.0	Vehicle serviced

		90 Verified Reviews   227 Customer Favorites	
03/22/2004	Florida Motor Vehicle Dept. Boca Raton, FL Title #0089600568		Registration issued or renewed - Titled or registered as personal vehicle - Vehicle color noted as Black
05/19/2004	7,139 Service Facility		 Vehicle serviced - Drivability/performance checked - A/C and heating system checked - Refrigerant added for leak check checked - A/C refrigerant recharged - A/C receiver/dryer replaced - A/C condenser replaced
05/19/2004	Mercedes-Benz of Pompano Pompano Beach, FL 954-943-5000 mercedesfla.com  4.3 / 5.0 90 Verified Reviews   227 Customer Favorites		 Vehicle serviced - Drivability/performance checked - A/C and heating system checked - A/C refrigerant recharged - A/C system serviced - A/C receiver/dryer replaced - A/C condenser replaced
06/08/2004	Mercedes-Benz of Fort Lauderdale Fort Lauderdale, FL 954-949-0623 mercedesfla.com  4.6 / 5.0 221 Verified Reviews   377 Customer Favorites		 Vehicle serviced - Maintenance inspection completed - Recommended maintenance performed - Oil and filter changed - Emissions system serviced - AIR injection pump replaced/repared
11/02/2004	Mercedes-Benz of Fort Lauderdale Fort Lauderdale, FL 954-949-0623 mercedesfla.com  4.6 / 5.0 221 Verified Reviews   377 Customer Favorites		 Vehicle serviced - Maintenance inspection completed - Body electrical system checked - Computer reprogrammed
12/17/2004	Mercedes-Benz of Fort Lauderdale Fort Lauderdale, FL 954-949-0623 mercedesfla.com  4.6 / 5.0 221 Verified Reviews   377 Customer Favorites		 Vehicle serviced
01/17/2005	Mercedes-Benz of Fort Lauderdale Fort Lauderdale, FL 954-949-0623 mercedesfla.com  4.6 / 5.0 221 Verified Reviews   377 Customer Favorites		 Vehicle serviced
03/22/2005	Florida Motor Vehicle Dept. Boca Raton, FL Title #0089600568		Registration issued or renewed - Titled or registered as personal vehicle - Vehicle color noted as Black
04/26/2005	Mercedes-Benz of Fort Lauderdale Fort Lauderdale, FL 954-949-0623 mercedesfla.com  4.6 / 5.0 221 Verified Reviews   377 Customer Favorites		 Vehicle serviced - Recommended maintenance performed - Oil and filter changed - Oil pan replaced/repared

06/30/2005	Mercedes-Benz of Fort Lauderdale Fort Lauderdale, FL 954-949-0623 mercedesfla.com ★ 4.6 / 5.0 221 Verified Reviews ✓ ♥ 377 Customer Favorites	 Vehicle serviced - Maintenance inspection completed - Emissions system serviced - Engine/powertrain computer/module checked - AIR injection pump replaced/repaired
03/01/2006	Mercedes-Benz of Fort Lauderdale Fort Lauderdale, FL 954-949-0623 mercedesfla.com ★ 4.6 / 5.0 221 Verified Reviews ✓ ♥ 377 Customer Favorites	 Vehicle serviced - Maintenance inspection completed - Oil and filter changed - Cabin air filter replaced/cleaned
04/05/2006	Florida Motor Vehicle Dept. Boca Raton, FL Title #0089600568	Registration issued or renewed - Titled or registered as personal vehicle - Vehicle color noted as Black
04/20/2006	Mercedes-Benz of Fort Lauderdale Fort Lauderdale, FL 954-949-0623 mercedesfla.com ★ 4.6 / 5.0 221 Verified Reviews ✓ ♥ 377 Customer Favorites	 Vehicle serviced - Maintenance inspection completed - Battery/charging system checked - Computer(s) checked - Engine/powertrain computer/module reprogrammed - Battery charged - Wiring harness installed - Body electrical system checked - Voltage regulator replaced
08/28/2006	Mercedes-Benz of Fort Lauderdale Fort Lauderdale, FL 954-949-0623 mercedesfla.com ★ 4.6 / 5.0 221 Verified Reviews ✓ ♥ 377 Customer Favorites	 Vehicle serviced - Maintenance inspection completed - Oil and filter changed - Fluids checked
10/12/2006	Mercedes-Benz of Fort Lauderdale Fort Lauderdale, FL 954-949-0623 mercedesfla.com ★ 4.6 / 5.0 221 Verified Reviews ✓ ♥ 377 Customer Favorites	 Vehicle serviced - Maintenance inspection completed - Axles checked - Battery replaced - Battery/charging system checked
12/30/2006	Mercedes-Benz of Fort Lauderdale Fort Lauderdale, FL 954-949-0623 mercedesfla.com ★ 4.6 / 5.0 221 Verified Reviews ✓ ♥ 377 Customer Favorites	 Vehicle serviced - Recommended maintenance performed - Maintenance inspection completed - Oil and filter changed - Battery replaced - Alternator replaced - Battery/charging system checked - Engine/powertrain computer/module checked - Tire pressure sensor replaced - Tire pressure monitoring system checked - Computer(s) checked - Wheel(s) replaced - Tire condition and pressure checked - Coolant level sensor replaced - Antifreeze/coolant checked - Emissions system serviced - AIR injection pump replaced/repaired
05/03/2007	Florida Motor Vehicle Dept. Boca Raton, FL Title #0089600568	Registration issued or renewed - Titled or registered as personal vehicle - Vehicle color noted as Black
09/20/2007	47,489 Mercedes-Benz of Daytona Beach Daytona Beach, FL 386-675-4677 daytonamercedes.com/index.htm	 Vehicle serviced

		<p>★ 4.2 / 5.0</p> <p>94 Verified Reviews ✓</p> <p>♥ 94 Customer Favorites</p>	
10/25/2007	47,490	<p>Mercedes-Benz of Fort Lauderdale Fort Lauderdale, FL 954-949-0623 mercedesfla.com</p> <p>★ 4.6 / 5.0</p> <p>221 Verified Reviews ✓</p> <p>♥ 377 Customer Favorites</p>	<p> Vehicle serviced</p>
02/28/2008		<p>Florida Motor Vehicle Dept. Boca Raton, FL Title #0089600568</p>	<p>Registration issued or renewed</p> <ul style="list-style-type: none"> - Titled or registered as personal vehicle - Vehicle color noted as Black
03/26/2008	53,723	<p>Mercedes-Benz of Fort Lauderdale Fort Lauderdale, FL 954-949-0623 mercedesfla.com</p> <p>★ 4.6 / 5.0</p> <p>221 Verified Reviews ✓</p> <p>♥ 377 Customer Favorites</p>	<p> Vehicle serviced</p> <ul style="list-style-type: none"> - Fuel system checked - Fuel level sending unit replaced
10/17/2008	56,431	<p>Mercedes-Benz of Fort Lauderdale Fort Lauderdale, FL 954-949-0623 mercedesfla.com</p> <p>★ 4.6 / 5.0</p> <p>221 Verified Reviews ✓</p> <p>♥ 377 Customer Favorites</p>	<p> Vehicle serviced</p> <ul style="list-style-type: none"> - Maintenance inspection completed
02/14/2009	60,049	<p>Mercedes-Benz of Fort Lauderdale Fort Lauderdale, FL 954-949-0623 mercedesfla.com</p> <p>★ 4.6 / 5.0</p> <p>221 Verified Reviews ✓</p> <p>♥ 377 Customer Favorites</p>	<p> Vehicle serviced</p> <ul style="list-style-type: none"> - Maintenance inspection completed - Fuel level sending unit replaced - Tire condition and pressure checked
02/23/2009	60,053	<p>Mercedes-Benz of Fort Lauderdale Fort Lauderdale, FL 954-949-0623 mercedesfla.com</p> <p>★ 4.6 / 5.0</p> <p>221 Verified Reviews ✓</p> <p>♥ 377 Customer Favorites</p>	<p> Vehicle serviced</p> <ul style="list-style-type: none"> - Tire pressure sensor replaced - Wheel(s) replaced
04/17/2009		<p>Florida Motor Vehicle Dept. Boca Raton, FL Title #0089600568</p>	<p>Registration issued or renewed</p> <ul style="list-style-type: none"> - Titled or registered as personal vehicle - Vehicle color noted as Black
10/14/2009		<p>Damage Report</p>	<p> Accident reported</p> <ul style="list-style-type: none"> - Damage to right rear

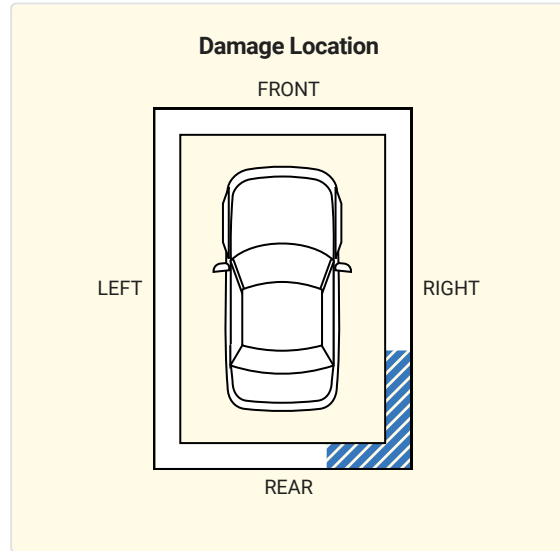

04/02/2010		Florida Motor Vehicle Dept. Boca Raton, FL Title #0089600568	Registration issued or renewed - Titled or registered as personal vehicle - Vehicle color noted as Black
09/01/2010	73,408	Mercedes-Benz of Fort Lauderdale Fort Lauderdale, FL 954-949-0623 mercedesfla.com ★ 4.6 / 5.0 221 Verified Reviews ✓ ♥ 377 Customer Favorites	Vehicle serviced - Maintenance inspection completed - Tire condition and pressure checked - Brakes checked - Fluids checked - Oil and filter changed
04/04/2011		Florida Motor Vehicle Dept. Boca Raton, FL Title #0089600568	Registration issued or renewed - Titled or registered as personal vehicle - Vehicle color noted as Black
05/18/2011	79,743	Mercedes-Benz of Fort Lauderdale Fort Lauderdale, FL 954-949-0623 mercedesfla.com ★ 4.6 / 5.0 221 Verified Reviews ✓ ♥ 377 Customer Favorites	Vehicle serviced - Maintenance inspection completed - Fluids checked - Oil and filter changed - Fuel system cleaned/serviced - Tire condition and pressure checked - Brakes checked
07/17/2011	80,848	Mercedes-Benz of Fort Lauderdale Fort Lauderdale, FL 954-949-0623 mercedesfla.com ★ 4.6 / 5.0 221 Verified Reviews ✓ ♥ 377 Customer Favorites	Vehicle serviced - Maintenance inspection completed - Recommended maintenance performed - Brakes checked - Tire condition and pressure checked
07/31/2011	81,095	Mercedes-Benz of Fort Lauderdale Fort Lauderdale, FL 954-949-0623 mercedesfla.com ★ 4.6 / 5.0 221 Verified Reviews ✓ ♥ 377 Customer Favorites	Vehicle serviced - Recommended maintenance performed - Tire condition and pressure checked - Crankshaft position sensor replaced - Brakes checked
10/26/2011		Damage Report	Accident reported - Damage to right front

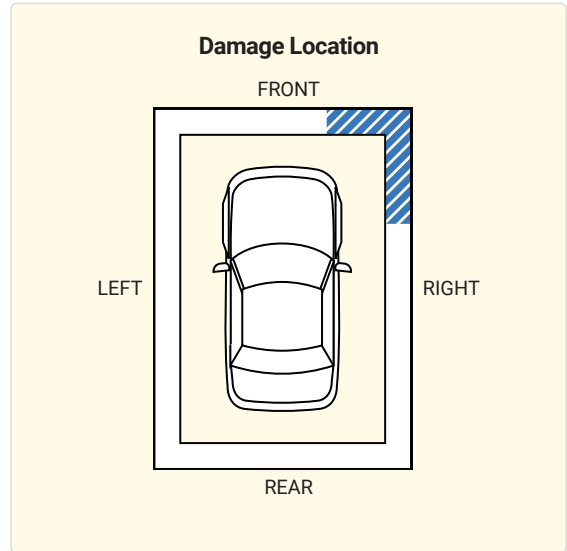

11/14/2011	82,871	<p>Mercedes-Benz of Coconut Creek Coral Springs, FL 954-406-1167 mercedesfla.com</p> <p>★ 4.5 / 5.0</p> <p>150 Verified Reviews ✓</p> <p>♥ 196 Customer Favorites</p>	<p>🔧 Vehicle serviced</p> <ul style="list-style-type: none"> - Body electrical wiring repaired - Tire condition and pressure checked
01/31/2012		<p>Mercedes-Benz of Pompano Pompano Beach, FL 954-943-5000 mercedesfla.com</p> <p>★ 4.3 / 5.0</p> <p>90 Verified Reviews ✓</p> <p>♥ 227 Customer Favorites</p>	<p>🔧 Vehicle serviced</p> <ul style="list-style-type: none"> - Maintenance inspection completed - No-start/hard start condition checked
03/20/2012	84,340	<p>Mercedes-Benz of Fort Lauderdale Fort Lauderdale, FL 954-949-0623 mercedesfla.com</p> <p>★ 4.6 / 5.0</p> <p>221 Verified Reviews ✓</p> <p>♥ 377 Customer Favorites</p>	<p>🔧 Vehicle serviced</p> <ul style="list-style-type: none"> - Maintenance inspection completed - Brakes checked
04/09/2012		<p>Florida Motor Vehicle Dept. Boca Raton, FL Title #0089600568</p>	<p>Registration issued or renewed</p> <ul style="list-style-type: none"> - Titled or registered as personal vehicle - Vehicle color noted as Black
08/31/2012		<p>Auto Critic Inc Pompano Beach, FL 954-771-0263 carsonlinefree.com/sites/inventory.cfm?dealerID=7831</p>	<p>🔧 Vehicle serviced</p> <ul style="list-style-type: none"> - Brakes checked - Wiper(s) replaced - Antifreeze/coolant flushed/changed - Serpentine belt replaced - Cabin air filter replaced/cleaned
11/15/2012	88,618	<p>Mercedes-Benz of Coconut Creek Coral Springs, FL 954-406-1167 mercedesfla.com</p> <p>★ 4.5 / 5.0</p> <p>150 Verified Reviews ✓</p> <p>♥ 196 Customer Favorites</p>	<p>🔧 Vehicle serviced</p> <ul style="list-style-type: none"> - Tire condition and pressure checked
02/26/2013		<p>Auto Critic Inc Pompano Beach, FL 954-771-0263 carsonlinefree.com/sites/inventory.cfm?dealerID=7831</p>	<p>🔧 Vehicle serviced</p> <ul style="list-style-type: none"> - Brake fluid flushed/changed

4.6 / 5.0

[221 Verified Reviews](#)
377 Customer Favorites

04/10/2015	Florida Motor Vehicle Dept. Boca Raton, FL Title #0089600568	Registration issued or renewed - Titled or registered as personal vehicle - Vehicle color noted as Black
05/13/2015	Florida Motor Vehicle Dept. Boca Raton, FL Title #0089600568	Registration issued or renewed - Titled or registered as personal vehicle - Vehicle color noted as Black
02/29/2016	102,985 Mercedes-Benz of Pompano Pompano Beach, FL 954-943-5000 mercedesfla.com 4.3 / 5.0 90 Verified Reviews 227 Customer Favorites	Vehicle serviced - Maintenance inspection completed - Fuel tank drained and cleaned - Fuel tank replaced - Tire condition and pressure checked
04/12/2016	Florida Motor Vehicle Dept. Boca Raton, FL Title #0089600568	Registration issued or renewed - Titled or registered as personal vehicle - Vehicle color noted as Black
04/19/2016	103,522 Mercedes-Benz of Pompano Pompano Beach, FL 954-943-5000 mercedesfla.com 4.3 / 5.0 90 Verified Reviews 227 Customer Favorites	Vehicle serviced - Maintenance inspection completed
11/22/2016	105,757 Mercedes-Benz of Fort Lauderdale Fort Lauderdale, FL 954-949-0623 mercedesfla.com 4.6 / 5.0 221 Verified Reviews 377 Customer Favorites	Vehicle offered for sale
11/30/2016	105,763 Mercedes-Benz of Fort Lauderdale Fort Lauderdale, FL 954-949-0623 mercedesfla.com 4.6 / 5.0 221 Verified Reviews 377 Customer Favorites	Vehicle serviced - Pre-delivery inspection completed - Battery replaced - Front brake rotor(s) replaced - Front brake pads replaced - Sensor replaced - Windshield replaced - Wiper(s) replaced - Tire(s) balanced - Tire(s) mounted - Vehicle washed/detailed
12/12/2016	Mercedes-Benz of Fort Lauderdale Fort Lauderdale, FL 954-949-0623 mercedesfla.com 4.6 / 5.0 221 Verified Reviews 377 Customer Favorites	Vehicle serviced
12/29/2016	Mercedes-Benz of Fort Lauderdale Fort Lauderdale, FL 954-949-0623 mercedesfla.com 4.6 / 5.0 221 Verified Reviews 377 Customer Favorites	Vehicle serviced - Fuel tank drained and cleaned - Vehicle washed/detailed
12/30/2016	Mercedes-Benz of Fort Lauderdale	Vehicle sold

Fort Lauderdale, FL
954-949-0623
mercedesfla.com

★ 4.6 / 5.0

[221 Verified Reviews](#) ✓

♥ 377 Customer Favorites

12/30/2016

Mercedes-Benz of Fort Lauderdale
Fort Lauderdale, FL
954-949-0623
mercedesfla.com



Vehicle serviced
- Pre-delivery inspection completed

★ 4.6 / 5.0

[221 Verified Reviews](#) ✓

♥ 377 Customer Favorites

Owner 2

Personal Vehicle

Purchased: 2016

Date	Mileage	Source	Comments
12/30/2016		Florida Motor Vehicle Dept. Opa Locka, FL Title #0089600568	Vehicle purchase reported - Title issued or updated - Registration issued or renewed - New owner reported - Titled or registered as personal vehicle - Loan or lien reported - Vehicle color noted as Black
01/10/2017	105,764	Mercedes-Benz of Pompano Pompano Beach, FL 954-943-5000 mercedesfla.com ★ 4.3 / 5.0 90 Verified Reviews ✓ ♥ 227 Customer Favorites	Vehicle serviced
01/24/2017		Florida Motor Vehicle Dept. Opa Locka, FL Title #0089600568	Title issued or updated - Registration issued or renewed - Titled or registered as personal vehicle - Loan or lien reported - Vehicle color noted as Black
07/19/2017		Florida Motor Vehicle Dept. Opa Locka, FL Title #0089600568	Registration issued or renewed - Titled or registered as personal vehicle - Loan or lien reported - Vehicle color noted as Black
12/24/2017		Dealer Inventory	Vehicle offered for sale
01/05/2018		Bomnin Chevrolet Dadeland Miami, FL 786-245-7584 bomninchevrolet.com ★ 3.8 / 5.0 40 Verified Reviews ✓ ♥ 191 Customer Favorites	Vehicle serviced - Maintenance inspection completed - Four wheel alignment performed - Engine/powertrain computer/module checked

Owner 3

Purchased: 2018



Low mileage! This owner drove less than the industry average of 15,000 miles per year.



Personal Vehicle

9,974 mi/yr

Date	Mileage	Source	Comments
01/15/2018	111,373	Florida Motor Vehicle Dept.	Vehicle purchase reported

02/13/2018	Florida Motor Vehicle Dept. Pompano Beach, FL Title #0089600568	Title issued or updated - Registration issued or renewed - New owner reported - Titled or registered as personal vehicle - Loan or lien reported - Vehicle color noted as Black
------------	--	---

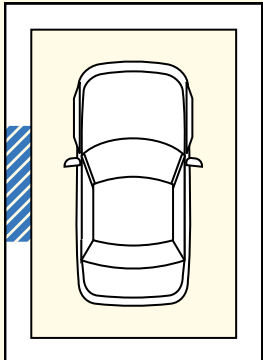
07/30/2018	Florida Motor Vehicle Dept. Pompano Beach, FL Title #0089600568	Registration issued or renewed - Titled or registered as personal vehicle - Loan or lien reported - Vehicle color noted as Black
------------	--	--

10/11/2018	Damage Report	<p>Damage reported: minor damage</p> <ul style="list-style-type: none"> - Damage to left side <div style="border: 1px solid #ccc; padding: 10px; margin: 10px 0;"> <p style="text-align: center;">Damage Severity Scale ⓘ</p> <div style="display: flex; align-items: center; justify-content: center;"> <div style="width: 20px; height: 15px; background: repeating-linear-gradient(45deg, transparent, transparent 2px, blue 2px, blue 4px); border: 1px solid black; margin-right: 10px;"></div> <div style="flex-grow: 1; border: 1px solid black; position: relative;"> <div style="position: absolute; left: -20px; top: 50%; transform: translateY(-50%);">MINOR</div> <div style="position: absolute; right: -20px; top: 50%; transform: translateY(-50%);">SEVERE</div> </div> </div> <p style="text-align: center; margin-top: 10px;">Damage Location</p> <div style="text-align: center;"> <p>FRONT</p>  <p>LEFT RIGHT</p> <p>REAR</p> </div> </div> <div style="text-align: center; margin-top: 20px;">  </div>
------------	---------------	---

11/01/2019	Florida Motor Vehicle Dept. Pompano Beach, FL Title #0089600568	Registration issued or renewed - Titled or registered as personal vehicle - Loan or lien reported - Vehicle color noted as Black
------------	--	--

11/20/2020	Florida Motor Vehicle Dept. Pompano Beach, FL Title #0089600568	<p>Registration issued or renewed</p> <ul style="list-style-type: none"> - Titled or registered as personal vehicle - Loan or lien reported - Vehicle color noted as Black <div style="text-align: center; margin-top: 20px;">  </div> <div style="border: 1px solid #ccc; padding: 10px; margin-top: 10px; text-align: center;"> <p>Avoid financial headaches. Make sure the loan has been paid off if you're buying from a private seller. Learn More</p> </div>
------------	--	---

12/28/2020	Damage Report	<p>Damage reported: minor damage</p> <ul style="list-style-type: none"> - Damage to front - Damage to right front
------------	---------------	--

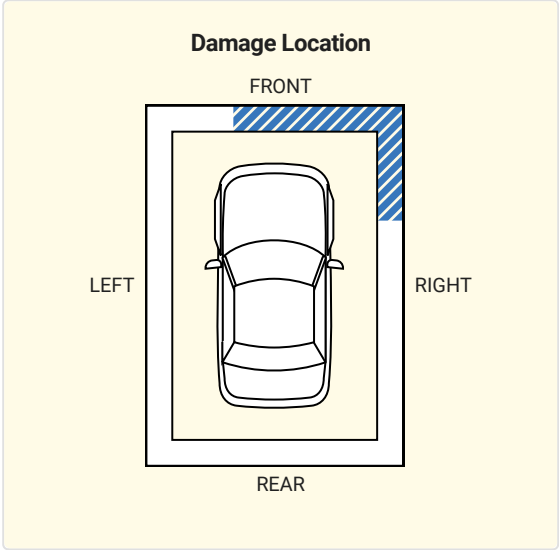
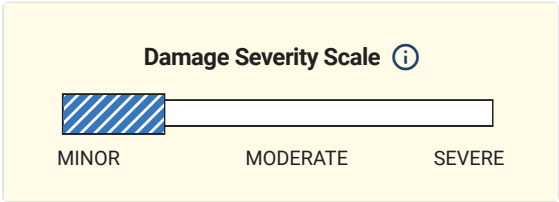

01/22/2021

Damage Report



Accident reported: minor to moderate damage

- Involving front or side impact
- It hit a parked motor vehicle
- Damage to left rear
- Damage to front
- Damage to right side
- Damage to right front
- Airbags did not deploy

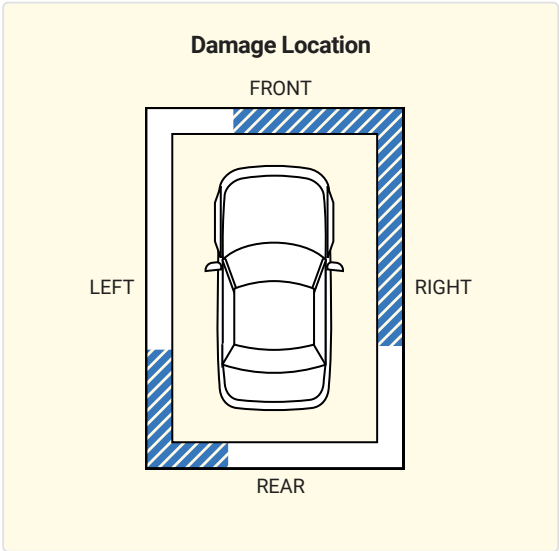
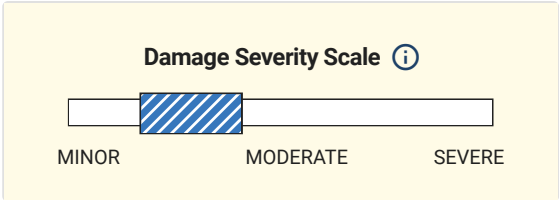

04/22/2021

143,974

RedLine BMW Performance Inc
Pompano Beach, FL
954-783-7003

★ 4.9 / 5.0

40 Verified Reviews



Vehicle serviced

- Spark plug(s) replaced

 51 Customer FavoritesHave Questions? Please visit our Help Center at www.carfax.com.

Glossary

Accident Indicator

CARFAX receives information about accidents in all 50 states, the District of Columbia and Canada.

Not every accident is reported to CARFAX. As details about the accident become available, those additional details are added to the CARFAX Vehicle History Report. CARFAX recommends that you have this vehicle inspected by a qualified mechanic.

- According to the National Safety Council, Injury Facts, 2015 edition, 8% of the 254 million registered vehicles in the U.S. were involved in an accident in 2013. Over 74% of these were considered minor or moderate.
- This CARFAX Vehicle History Report is based only on information supplied to CARFAX and available as of 4/23/21 at 9:50:02 PM (CDT). Other information about this vehicle, including problems, may not have been reported to CARFAX. Use this report as one important tool, along with a vehicle inspection and test drive, to make a better decision about your next used car.

Damage Indicator

Damage can be a result of many different types of events. Examples include contact with objects (other cars, trees, traffic signs, road debris, etc), vandalism, or weather-related events. Not every damage event is reported to CARFAX. As details about the damage event become available, those additional details are added to the CARFAX Vehicle History Report. CARFAX recommends that you have this vehicle inspected by a qualified mechanic.

- This CARFAX Vehicle History Report is based only on information supplied to CARFAX and available as of 4/23/21 at 9:50:02 PM (CDT). Other information about this vehicle, including problems, may not have been reported to CARFAX. Use this report as one important tool, along with a vehicle inspection and test drive, to make a better decision about your next used car.

Damage Severity

Damage events result in one of the following severity levels:

- Minor: Generally, minor damage is cosmetic (including dents or scratches), may only require reconditioning, and typically does not compromise a vehicle's operation and/or safety.
- Moderate: Moderate damage may affect multiple components of the vehicle and may impair the vehicle's operation and/or safety.
- Severe: Severe damage usually affects multiple components of the vehicle and is likely to compromise the vehicle's operation and/or safety.

CARFAX recommends getting a pre-purchase inspection at a certified collision repair facility.

First Owner

When the first owner(s) obtains a title from a Department of Motor Vehicles as proof of ownership.

New Owner Reported

When a vehicle is sold to a new owner, the Title must be transferred to the new owner(s) at a Department of Motor Vehicles.

Ownership History

CARFAX defines an owner as an individual or business that possesses and uses a vehicle. Not all title transactions represent changes in ownership. To provide estimated number of owners, CARFAX proprietary technology analyzes all the events in a vehicle history. Estimated ownership is available for vehicles manufactured after 1991 and titled solely in the US including Puerto Rico. Dealers sometimes opt to take ownership of a vehicle and are required to in the following states: Maine, Massachusetts, New Jersey, Ohio, Oklahoma, Pennsylvania and South Dakota. Please consider this as you review a vehicle's estimated ownership history.

Title Issued

A state issues a title to provide a vehicle owner with proof of ownership. Each title has a unique number. Each title or registration record on a CARFAX report does not necessarily indicate a change in ownership. In Canada, a registration and bill of sale are used as proof of ownership.

Follow Us:

[facebook.com/CARFAX](https://www.facebook.com/CARFAX)[@CARFAXinc](https://twitter.com/CARFAXinc)

About CARFAX

CARFAX DEPENDS ON ITS SOURCES FOR THE ACCURACY AND RELIABILITY OF ITS INFORMATION. THEREFORE, NO RESPONSIBILITY IS ASSUMED BY CARFAX OR ITS AGENTS FOR ERRORS OR OMISSIONS IN THIS REPORT. CARFAX FURTHER EXPRESSLY DISCLAIMS ALL WARRANTIES, EXPRESS OR IMPLIED, INCLUDING ANY IMPLIED WARRANTIES OF MERCHANTABILITY OR FITNESS FOR A PARTICULAR PURPOSE.

4/23/2021

CARFAX Vehicle History Report for this 2004 MERCEDES-BENZ E55 AMG: WDBUF76JX4A420632

© 2021 CARFAX, Inc., a unit of IHS Markit Ltd. All rights reserved.
4/23/21 9:50:02 PM (CDT)