

Engine 157, 278 in model 212, 218  
 Engine 278 in model 207

Shown on model 207 with engine 278 except code 139 (measures for engine cooling M157/M278) and except code 803 (model year 2013)

- 1 Central engine cover
- 2 Left engine air intake duct
- 3 Left air filter housing
- 4 Engine charge air duct
- 5 Engine charge air duct
- 6 Turbocharger
- 7 Coolant thermostat housing
- 8 Bracket
- 9 Bracket
- 10 Coolant line
- 11 Retaining clamp
- 18 Oil filter housing
- 20 Screw plug

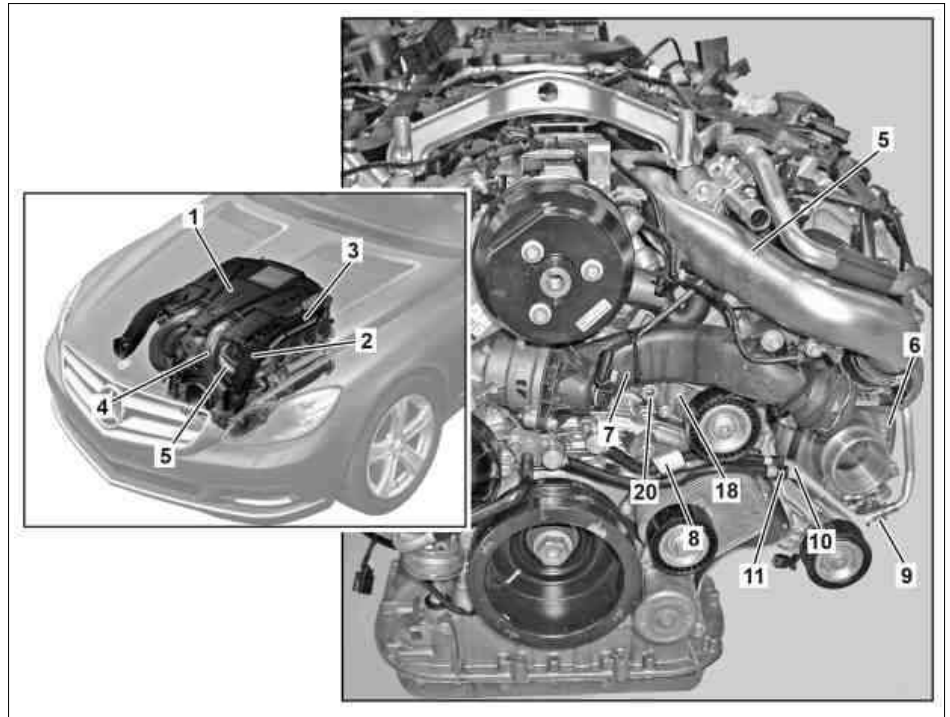

P18.20-2102-06

Shown on model with engine 278 except code 139 (measures for engine cooling M157/M278) and except code 803 (model year 2013)

- 9 Bracket
- 10 Coolant lines
- 11 Retaining clips
- 12 Guide pulley
- 18 Oil filter housing
- 20 Screw plug
- 21 Screw
- 22 Screw
- 23 Screw
- 24 Screw
- 25 Screw
- 26 Screw
- 27 Screw

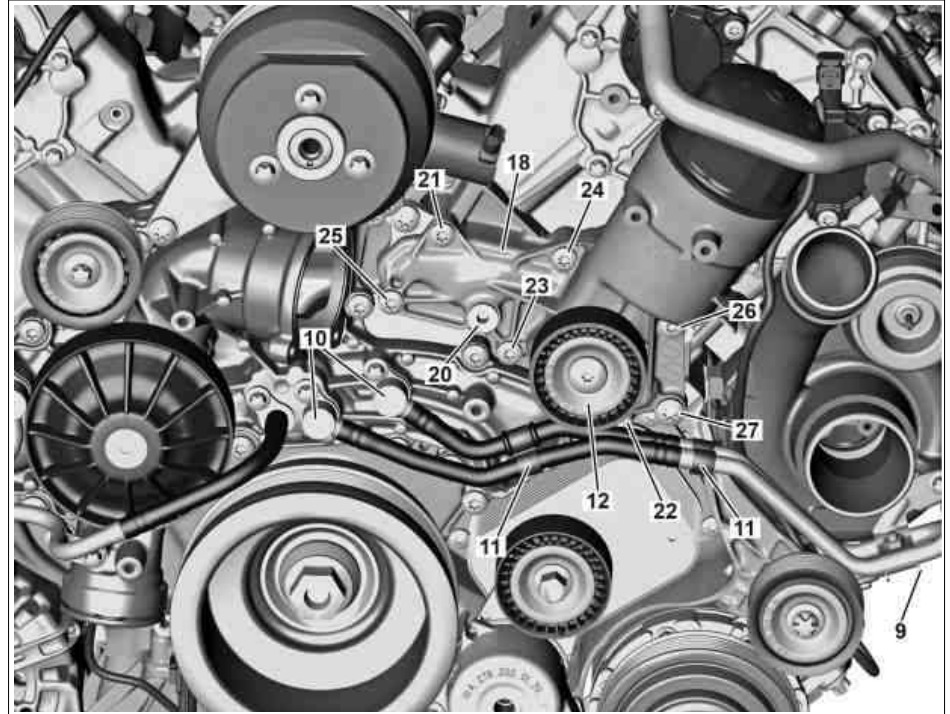



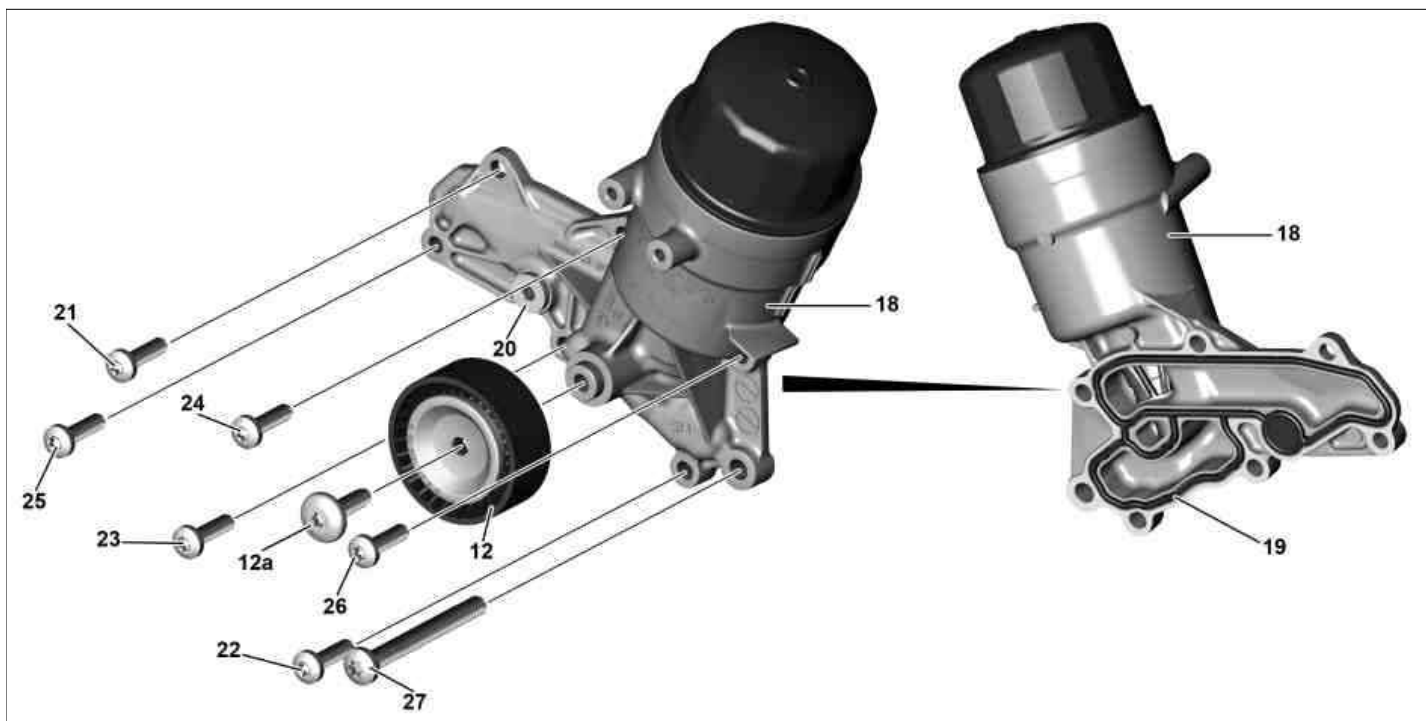









P18.20-2104-06



P18.20-2103-09

12	Guide pulley	20	Screw plug	24	Screw
12a	Screw	21	Screw	25	Screw
18	Oil filter housing	22	Screw	26	Screw
19	Seal	23	Screw	27	Screw

⚠ Warning	<b>Risk of injury</b> to skin and eyes suffering scalding from contact with hot coolant spray. <b>Risk of poisoning</b> from swallowing coolant.	Do not open cooling system unless coolant temperature is below 90 °C. Open cap slowly and release the pressure. Do not pour coolant into beverage containers. Wear protective gloves, protective clothing and safety glasses.	AS20.00-Z-0001-01A
⚠ Warning	<b>Risk of injury.</b> Skin or eye injuries may result when handling hot or glowing objects.	Wear protective gloves, protective clothing and safety glasses, if necessary.	AS00.00-Z-0002-01A
⚠ Caution	<b>Risk of injury</b> caused by scraping or cutting body parts on sharp vehicle parts	Always wear protective gloves when working on or near sharp and non-deburred vehicle parts. Deburr repair panels.	AS00.00-Z-0017-01A
⚠ Caution	<b>Risk of injury</b> to skin and eyes due to handling of engine oil. <b>Risk of poisoning</b> caused by swallowing engine oil	Wear protective gloves, protective clothing and safety glasses. Do not fill engine oil into beverage containers.	AS18.00-Z-0001-01A
	Notes on avoiding damage through contamination and foreign objects		AH00.00-P-5000-01A
	Notes on safety-relevant components		AH00.00-Z-0019-01A
⚠ ⚠	<b>Remove/install</b>		
1	Remove central engine cover (1)	<b>i Installation:</b> Only install central engine cover (1) after the leak test.	
2	Remove left engine intake air duct (2)		
3	Remove oil lines of engine oil cooler with brackets for oil filter housing (18), cylinder head cover and timing case cover, set aside and close off connections using suitable stop plugs	Engine 157, 278 in model 212, 218 with code 139 (M157/M278 engine cooling measures) with code 803 (Model year 2013) Engine 278 in model 207 with code 139 (M157/M278 engine cooling measures) with code 803 (Model year 2013) <b>Nm</b> Bolt, bracket for oil cooler line to engine <b>Nm</b> Bolt, oil cooler line to oil filter housing	*BA18.30-P-1006-01G *BA18.30-P-1005-01G

		 Record plug	*129589009100
4	Remove left air filter housing (3)		
5	Remove engine charge air duct (4, 5)		AR09.41-P-8620ELB
6	Drain off coolant	Engine 278 in model 207 Engine 157, 278 in model 212, 218  <b>Installation:</b> Only install lower engine compartment paneling after leak test.	AR20.00-P-1142FH AR20.00-P-1142EL
7	Remove poly-V belt		AR13.20-P-0001ELB
8	Remove coolant thermostat housing (7)		AR20.10-P-2460ELB
9	Remove bracket (8) from timing case cover	 M6 × 1	*BA00.10-P-1002-04A
10	Remove bracket (9)	 Bolt, coolant line clamp to bracket	*BA09.40-P-1009-01R
11	Remove retaining clamp (11)	Engine 157, 278 in model 212, 218 except code 139 (M157/M278 engine cooling measures) except code 803 (Model year 2013) Engine 278 in model 207 except code 139 (M157/M278 engine cooling measures) except code 803 (Model year 2013)	
12	Remove bolt (12a) and remove guide pulley (12)		AR13.20-P-0001ELB
13	Remove coolant lines (10) from coolant pump and close off connections using suitable stop plugs	Engine 157, 278 in model 212, 218 except code 139 (M157/M278 engine cooling measures) except code 803 (Model year 2013) Engine 278 in model 207 except code 139 (M157/M278 engine cooling measures) except code 803 (Model year 2013) Engine 157, 278 in model 212, 218 with code 139 (M157/M278 engine cooling measures) with code 803 (Model year 2013) Engine 278 as of 3/1/12 in model 207.3/4 with code 139 (M157/M278 engine cooling measures) with code 803 (Model year 2013)  Record plug	AR20.20-P-7440ELB  AR20.20-P-7443ELB  *129589009100
14	Remove screw/bolts (21, 22, 23, 24, 25, 26, 27) and remove oil filter housing (18) from timing case cover	Bolt plan for oil filter housing   <b>Installation:</b> Always observe tightening sequence for oil filter housing (18). Damage and leaks can occur on oil filter housing (18) or timing case cover otherwise.  <b>Installation:</b> Replace seal (19).  Engine 157Screw plug to oil filter housing  Engine 157Bolt, oil filter housing to timing case cover  Engine 278Screw plug to oil filter housing  Engine 278Bolt, oil filter housing to timing case cover	AR18.20-P-3471-01MMB     *BA18.20-P-1002-01Z *BA18.20-P-1003-01Z *BA18.20-P-1005-01Y *BA18.20-P-1006-01Y
15	Install in the reverse order		
16	Check engine oil level and correct		AP18.00-P-1811MP
 <b>Warning</b>	<b>Risk of accident</b> from vehicle starting off by itself when engine running. <b>Risk of injury</b> (bruises and burns) resulting from working on the engine while it is being started or when it is running.	Secure vehicle to prevent it from starting off by itself. Wear buttoned-up and snug-fitting work clothes. Do not touch hot or rotating parts.	AS00.00-Z-0005-01A
17	Perform an engine test run and check engine for proper operation and leaktightness		
18	Install lower engine compartment paneling		AR61.20-P-1105EW
19	Install central engine cover (1)		

 Metric screws/bolts and nuts as per MBN 10 105, 10 143

Number	Designation		8.8	10.9
BA00.10-P-1002-04A	M6×1	Nm	9	13

**Nm** Turbocharger

Number	Designation		Engine 157	Engine 278
BA09.40-P-1009-01R	Bolt, coolant line clamp to bracket	Nm	9	9

**Nm** Oil filter

Number	Designation		Engine 157
BA18.20-P-1002-01Z	Screw plug to oil filter housing	M12 Nm	20

**Nm** Oil filter

Number	Designation		Engine 157		
BA18.20-P-1003-01Z	Bolt, oil filter housing to timing case cover	M7	Stage 1	Nm	5
			Stage 2	Nm	14
		M8	Stage 1	Nm	5
			Stage 2	Nm	20

**Nm** Oil filter

Number	Designation		Engine 278
BA18.20-P-1005-01Y	Screw plug to oil filter housing	M12 Nm	20

**Nm** Oil filter

Number	Designation		Engine 278		
BA18.20-P-1006-01Y	Bolt, oil filter housing to timing case cover	M7	Stage 1	Nm	5
			Stage 2	Nm	14
		M8	Stage 1	Nm	5
			Stage 2	Nm	20

**Nm** Oil cooling system

Number	Designation		Engine 157	Engine 278
BA18.30-P-1005-01G	Bolt, oil cooler line to oil filter housing	Nm	9	8

**Nm** Oil cooling system

Number	Designation		Engine 157	Engine 278
BA18.30-P-1006-01G	Bolt, bracket for oil cooler line to engine	Nm	–	8

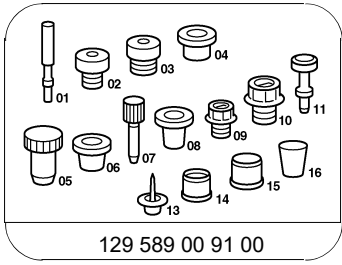

Record plug