

- Parts list -

|                         |                         |                                  |                   |
|-------------------------|-------------------------|----------------------------------|-------------------|
| <b>Vehicle</b>          | WDD2120761A973970 (D04) | Mercedes-AMG E 63 S 4MATIC Sedan |                   |
| <b>Color</b>            | 197 - undefined         | <b>Equipment</b>                 | 821 -             |
| <b>Assortment class</b> | PC                      | <b>Group</b>                     | 01 ENGINE HOUSING |
| <b>Sub-group</b>        | 030 TIMING CASE         |                                  |                   |

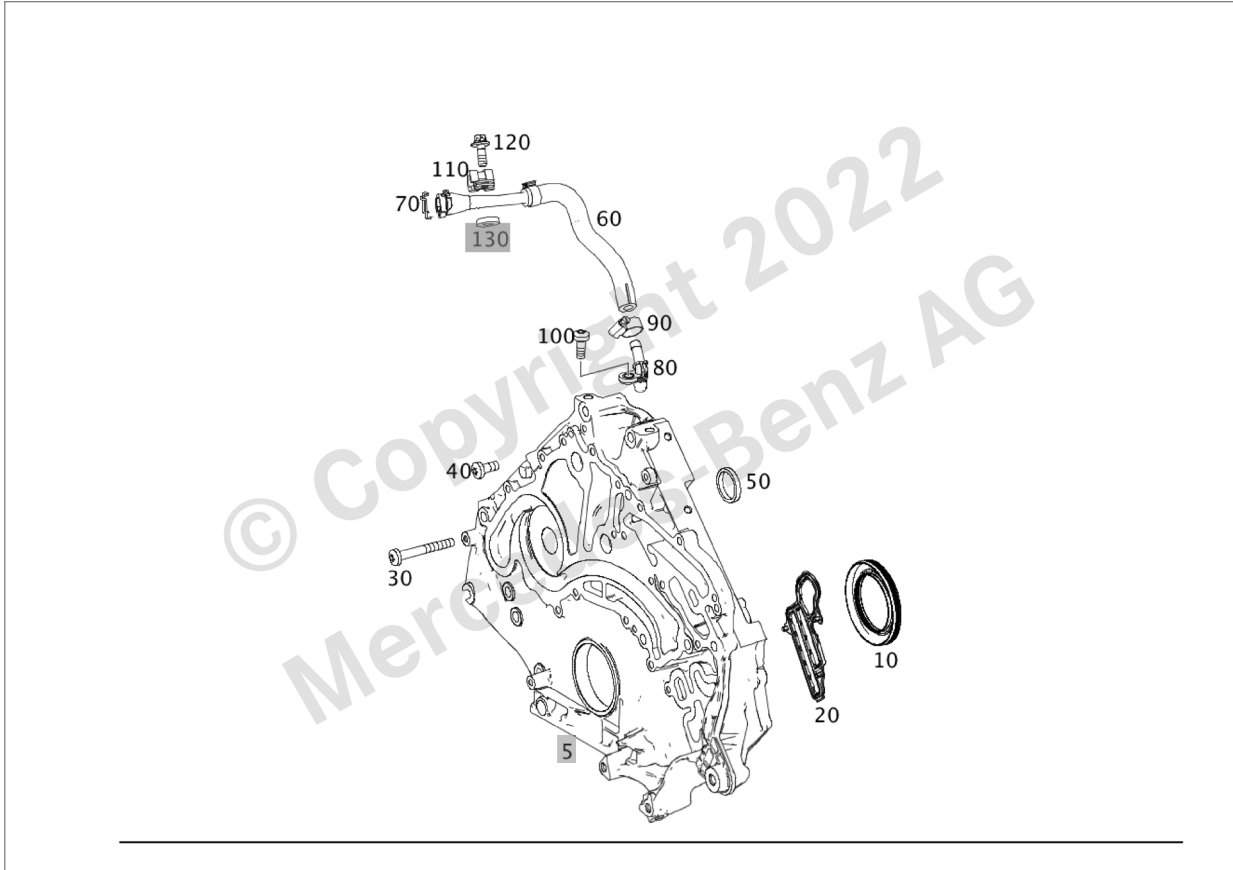









Image ID: drawing\_B01030000323

| Item | Part number                                                                                            | Designation/additional information                           | Qty |
|------|--------------------------------------------------------------------------------------------------------|--------------------------------------------------------------|-----|
| 5    | A 278 015 02 00                                                                                        | TIMING CASE                                                  | 1   |
| 10   | A 014 997 70 46<br> | RADIAL SHAFT SEALING RING                                    | 1   |
| 10   | A 023 997 84 47<br> | SEALING RING                                                 | 1   |
| 20   | A 278 015 00 80                                                                                        | ELASTOMER MOLDED SEAL<br>Timing case to cylinder crankcase   | 1   |
| 30   | N 000000 001431                                                                                        | HEXALOBULAR BOLT<br>Timing case to cylinder crankcase; M8X65 | 6   |
| 30   | N 000000 001433                                                                                        | HEXALOBULAR BOLT<br>Timing case to cylinder crankcase; M8X80 | 1   |
| 40   | N 000000 002191                                                                                        | HEXALOBULAR BOLT<br>Timing case to cylinder crankcase; M8X35 | 3   |
| 40   | N 000000 001427                                                                                        | HEXALOBULAR BOLT<br>Timing case to cylinder crankcase; M8X20 | 1   |
| 50   | A 020 997 05 45                                                                                        | FLAT SEALING RING<br>Timing case to cylinder crankcase       | 1   |

Parts Information

| Item | Part number                                                                                          | Designation/additional information                                                                                             | Qty |
|------|------------------------------------------------------------------------------------------------------|--------------------------------------------------------------------------------------------------------------------------------|-----|
| 60   | A 278 203 12 17<br> | BLEED LINE<br>To timing case<br> Code: -F463; | 1   |
| 70   | A 007 993 40 01<br> | * CATCH SPRING<br>8.8 MM                                                                                                       | 1   |
| 80   | A 009 997 29 72<br> | HOSE FITTING<br> Code: -F463;                 | 1   |
| 80   | A 009 997 39 72<br> | HOSE FITTING<br> Code: -F463;                 | 1   |
| 90   | A 000 995 35 07                                                                                      | CLAMP<br>Bleed line to timing case; 12-22 MM                                                                                   | 1   |
| 100  | A 000 990 61 37                                                                                      | HEXALOBULAR BOLT<br>Fitting to timing case; M6X16                                                                              | 1   |
| 110  | N 000000 001045                                                                                      | CLAMP<br>Bleed line mount; 10/15                                                                                               | 1   |
| 120  | N 910143 006000<br> | HEXALOBULAR BOLT<br>Bleed line mount; M6X12                                                                                    | 1   |